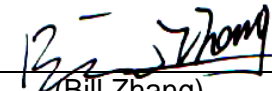

EMC Test Report

Project No. : 1707C063
Equipment : IP Phone
Test Model : X5S
Applicant : Fanvil Technology Co.Ltd
Address : 3F, Block A, Gaoxinqi Building, Anhua Industrial Park,
Qianjin 1st Rd. 35th Dist., Bao'An, Shenzhen, 518101,
China

Date of Receipt : Jul. 07, 2017
Date of Test : Jul. 07, 2017 ~ Aug. 11, 2017
Issued Date : Aug. 14, 2017
Tested by : BTL Inc.

Testing Engineer : 
(Jason Yang)

Technical Manager : 
(Bill Zhang)

Authorized Signatory : 
(Steven Lu)

B T L I N C .

No.3, Jinshagang 1st Road, Shixia, Dalang Town, Dongguan,
Guangdong, China.

TEL: +86-769-8318-3000 FAX: +86-769-8319-6000



Declaration

BTL represents to the client that testing is done in accordance with standard procedures as applicable and that test instruments used has been calibrated with standards traceable to international standard(s) and/or national standard(s).

BTL's reports apply only to the specific samples tested under conditions. It is manufacture's responsibility to ensure that additional production units of this model are manufactured with the identical electrical and mechanical components. **BTL** shall have no liability for any declarations, inferences or generalizations drawn by the client or others from **BTL** issued reports.

BTL's report must not be used by the client to claim product certification, approval, or endorsement by NVLAP, NIST, or any agency of the Federal Government.

This report is the confidential property of the client. As a mutual protection to the clients, the public and **BTL-self**, extracts from the test report shall not be reproduced except in full with **BTL's** authorized written approval.

BTL's laboratory quality assurance procedures are in compliance with the **ISO Guide 17025** requirements, and accredited by the conformity assessment authorities listed in this test report.

Limitation

For the use of the authority's logo is limited unless the Test Standard(s)/Scope(s)/Item(s) mentioned in this test report is (are) included in the conformity assessment authorities acceptance respective.

Table of Contents**Page**

REPORT ISSUED HISTORY	6
1 . CERTIFICATION	7
2 . SUMMARY OF TEST RESULTS	8
2.1 TEST FACILITY	10
2.2 MEASUREMENT UNCERTAINTY	10
3 . GENERAL INFORMATION	12
3.1 GENERAL DESCRIPTION OF EUT	12
3.2 DESCRIPTION OF TEST MODES	12
3.3 EUT OPERATING CONDITIONS	13
3.4 BLOCK DIAGRAM SHOWING THE CONFIGURATION OF SYSTEM TESTED	14
3.5 DESCRIPTION OF SUPPORT UNITS	15
4 . EMC EMISSION TEST	16
4.1 RADIATED EMISSION	16
4.1.1 LIMITS	16
4.1.2 MEASUREMENT INSTRUMENTS LIST	18
4.1.3 TEST PROCEDURE	19
4.1.4 DEVIATION FROM TEST STANDARD	20
4.1.5 TEST SETUP	20
4.1.6 MEASUREMENT DISTANCE	21
4.1.7 TEST RESULTS (UP TO 1 GHZ)	22
4.1.8 TEST RESULTS (ABOVE 1 GHZ)	36
4.2 CONDUCTED EMISSION MEASUREMENT AT AC MAINS POWER PORTS	50
4.2.1 LIMITS	50
4.2.2 MEASUREMENT INSTRUMENTS LIST	50
4.2.3 TEST PROCEDURE	51
4.2.4 DEVIATION FROM TEST STANDARD	51
4.2.5 TEST SETUP	51
4.2.6 TEST RESULTS	52
4.3 ASYMMETRIC MODE CONDUCTED EMISSIONS TEST	60
4.3.1 LIMITS	60
4.3.2 MEASUREMENT INSTRUMENTS LIST	62
4.3.3 TEST PROCEDURE	62
4.3.4 DEVIATION FROM TEST STANDARD	62
4.3.5 TEST SETUP	63
4.3.6 TEST RESULTS	64
4.4 HARMONIC CURRENT EMISSIONS TEST	74
4.4.1 LIMITS	74
4.4.2 MEASUREMENT INSTRUMENTS LIST	74

Table of Contents

Page

4.4.3 TEST PROCEDURE	75
4.4.4 DEVIATION FROM TEST STANDARD	75
4.4.5 TEST SETUP	75
4.4.6 TEST RESULTS	76
4.5 VOLTAGE CHANGES, VOLTAGE FLUCTUATIONS AND FLICKER TEST	79
4.5.1 LIMITS	79
4.5.2 MEASUREMENT INSTRUMENTS LIST	79
4.5.3 TEST PROCEDURE	79
4.5.4 DEVIATION FROM TEST STANDARD	79
4.5.5 TESTSETUP	80
4.5.6 TEST RESULTS	81
5 . EMC IMMUNITY TEST	82
5.1 STANDARD COMPLIANCE/SEVERITY LEVEL/CRITERIA	82
5.2 GENERAL PERFORMANCE CRITERIA	84
5.3 ELECTROSTATIC DISCHARGE IMMUNITY TEST (ESD)	85
5.3.1 TEST SPECIFICATION	85
5.3.2 MEASUREMENT INSTRUMENTS	85
5.3.3 TEST PROCEDURE	85
5.3.4 DEVIATION FROM TEST STANDARD	86
5.3.5 TEST SETUP	86
5.3.6 TEST RESULTS	87
5.4 RADIATED, RADIO-FREQUENCY, ELECTROMAGNETIC FIELD IMMUNITY TEST (RS)	91
5.4.1 TEST SPECIFICATION	91
5.4.2 MEASUREMENT INSTRUMENTS	91
5.4.3 TEST PROCEDURE	91
5.4.4 DEVIATION FROM TEST STANDARD	91
5.4.5 TEST SETUP	92
5.4.6 TEST RESULTS	93
5.5 ELECTRICAL FAST TRANSIENT/BURST IMMUNITY TEST (EFT/BURST)	126
5.5.1 TEST SPECIFICATION	126
5.5.2 MEASUREMENT INSTRUMENTS	126
5.5.3 TEST PROCEDURE	126
5.5.4 DEVIATION FROM TEST STANDARD	126
5.5.5 TEST SETUP	127
5.5.6 TEST RESULTS	128
5.6 SURGE IMMUNITY TEST	129
5.6.1 TEST SPECIFICATION	129
5.6.2 MEASUREMENT INSTRUMENTS	129
5.6.3 TEST PROCEDURE	130
5.6.4 DEVIATION FROM TEST STANDARD	130

Table of Contents	Page
5.6.5 TEST SETUP	130
5.6.6 TEST RESULTS	131
5.7 IMMUNITY TO CONDUCTED DISTURBANCES, INDUCED BY	
RADIO-FREQUENCY FIELDS TEST (CS)	132
5.7.1 TEST SPECIFICATION	132
5.7.2 MEASUREMENT INSTRUMENTS	132
5.7.3 TEST PROCEDURE	132
5.7.4 DEVIATION FROM TEST STANDARD	132
5.7.5 TEST SETUP	133
5.7.6 TEST RESULTS	134
5.8 POWER FREQUENCY MAGNETIC FIELD IMMUNITY TEST (PFMF)	145
5.8.1 TEST SPECIFICATION	145
5.8.2 MEASUREMENT INSTRUMENTS	145
5.8.3 TEST PROCEDURE	145
5.8.4 DEVIATION FROM TEST STANDARD	145
5.8.5 TEST SETUP	146
5.8.6 TEST RESULTS	147
5.9 VOLTAGE DIPS, SHORT INTERRUPTIONS AND VOLTAGE VARIATIONS	
IMMUNITY TEST	148
5.9.1 TEST SPECIFICATION	148
5.9.2 MEASUREMENT INSTRUMENTS	148
5.9.3 TEST PROCEDURE	148
5.9.4 DEVIATION FROM TEST STANDARD	148
5.9.5 TEST SETUP	149
5.9.6 TEST RESULTS	150
6 . EUT TEST PHOTO	151

REPORT ISSUED HISTORY

Issued No.	Description	Issued Date
BTL-EMC-1-1707C063	Original Issue.	Aug. 14, 2017

1. CERTIFICATION

Equipment : IP Phone
Brand Name : Fanvil
Test Model : X5S
Applicant : Fanvil Technology Co.Ltd
Manufacturer : Fanvil Technology Co.Ltd
Address : 3F, Block A, Gaoxinqi Building, Anhua Industrial Park, Qianjin 1st Rd. 35th
Dist., Bao'An, Shenzhen, 518101, China
Factory : Fanvil Technology Co.Ltd
Address : 3F, Block A, Gaoxinqi Building, Anhua Industrial Park, Qianjin 1st Rd. 35th
Dist., Bao'An, Shenzhen, 518101, China
Date of Test : Jul. 07, 2017 ~ Aug. 11, 2017
Test Sample : Engineering Sample
Standard(s) : EN 55032: 2015 Class B
EN 61000-3-2: 2014 Class A
EN 61000-3-3: 2013
EN 55024: 2010+A1:2015
EN 61000-4-2: 2009
EN 61000-4-3: 2006+A1:2008+A2:2010
EN 61000-4-4: 2012
EN 61000-4-5: 2014
EN 61000-4-6: 2014+AC:2015
EN 61000-4-8: 2010
EN 61000-4-11: 2004

The above equipment has been tested and found compliance with the requirement of the relative standards by BTL Inc.

The test data, data evaluation, and equipment configuration contained in our test report (Ref No. BTL-EMC-1-1707C063) were obtained utilizing the test procedures, test instruments, test sites that has been accredited by the Authority of TAF according to the ISO-17025 quality assessment standard and technical standard(s).

2. SUMMARY OF TEST RESULTS

Test procedures according to the technical standards:

Emission					
Standard(s)	Test Item	Limit	Judgment	Remark	
EN 55032: 2015	Radiated emissions up to 1 GHz	Class B	PASS		
	Radiated emissions above 1 GHz	Class B	PASS	NOTE (2)	
	Radiated emissions from FM receivers	-----	N/A	NOTE (1) NOTE (6)	
	Conducted emissions AC mains power port	Class B	PASS	NOTE (7)	
	Asymmetric mode conducted emissions	AAN	-----	PASS	NOTE (1) NOTE (8)
		Current Probe	-----	N/A	
		CVP	-----	N/A	
Conducted differential voltage emissions	-----	N/A	NOTE (1) NOTE (9)		

Standard	Test Item	Limit	Judgment	Remark
EN 61000-3-2:2014	Harmonic current emissions	Class A	PASS	NOTE (3)
EN 61000-3-3:2013	Voltage changes, voltage fluctuations and flicker	-----	PASS	

Immunity EN 55024: 2010				
Section(s)	Test Item	Performance Criterion	Judgment	Remark
EN 61000-4-2:2009	Electrostatic discharge immunity	B	PASS	
EN 61000-4-3: 2006+A1:2008+A2:2010	Radiated, radio-frequency, electromagnetic field immunity	A	PASS	
EN 61000-4-4:2012	Electrical fast transient/burst immunity	B	PASS	
EN 61000-4-5:2014	Surge immunity	B/C	PASS	NOTE (4)
EN 61000-4-6: 2014+AC :2015	Immunity to conducted disturbances, induced by radio-frequency fields	A	PASS	
EN 61000-4-8:2010	Power frequency magnetic field immunity	A	PASS	
EN 61000-4-11:2004	Voltage dips, short interruptions and voltage variations immunity	B / C / C	PASS	NOTE (5)

NOTE:

- (1) "N/A" denotes test is not applicable to this device.
- (2) The EUT's max operating frequency is 500 MHz which does exceed 108 MHz, so the test will be performed.
- (3) If the power consumption is less than 75W, there is no limit applied.
- (4) Performance Criterion C for signal ports and telecommunication ports.
Performance Criterion B for input d.c. power port and a.c. power ports.
- (5) Voltage Dips: >95% reduction – Performance Criterion B
Voltage Dips: 30% reduction – Performance Criterion C
Voltage Interruptions: >95% reduction – Performance Criterion C
- (6) If the EUT has FM function the test will be performed.
- (7) If the EUT has AC power mains port the test will be performed.
- (8)

Cable Type	Number of pairs	Measurement type	Procedures
Balanced Unscreened	1 (2 wire) ;2 (4 wire); 3 (6 wire) ;4 (8 wire)	Voltage	AAN
Balanced Unscreened	See a)	Voltage and Current	CP+CVP
Screened or Coaxial	n/a	Voltage	AAN
Screened or Coaxial	n/a	Voltage or Current	CP or CVP
Unbalanced cables	n/a	Voltage and Current	CP+CVP

Ports connected to cables with more than 4 balanced pairs or where the port is unable to function correctly when connected through an AAN.

- (9) If the EUT has tuner port the test will be performed.
- (10) The requirement followed by the client's specification.

2.1 TEST FACILITY

The test facilities used to collect the test data in this report is at the location of No.3, Jinshagang 1st Road, Shixia, Dalang Town, Dongguan, Guangdong, China.

2.2 MEASUREMENT UNCERTAINTY

Where relevant, the following measurement uncertainty levels have been estimated for tests performed on the EUT as specified in CISPR 16-4-2, The BTL measurement uncertainty is less than the CISPR 16-4-2 U_{CISPR} requirement.

The reported uncertainty of measurement $y \pm U$, where expanded uncertainty U is based on a standard uncertainty multiplied by a coverage factor of $k=2$, providing a level of confidence of approximately **95%**.

A. Radiated emissions up to 1 GHz measurement:

Test Site	Method	Measurement Frequency Range	Ant. H / V	U, (dB)
DG-CB08 (10m)	CISPR	30MHz ~ 200MHz	V	4.66
		30MHz ~ 200MHz	H	4.64
		200MHz ~ 1,000MHz	V	4.88
		200MHz ~ 1,000MHz	H	4.86

B. Radiated emissions above 1 GHz measurement:

Test Site	Method	Measurement Frequency Range	U, (dB)
DG-CB08 (3m)	CISPR	1 ~ 6 GHz	4.26
		6 ~ 18 GHz	5.30

C. Conducted emissions AC mains power port measurement:

Test Site	Method	Measurement Frequency Range	U, (dB)
DG-C01	CISPR	150 kHz ~ 30MHz	3.16

D. Conducted disturbance at telecommunication port measurement:

Test Site	Method	Measurement Frequency Range	U, (dB)
DG-C01	CISPR	AAN 50...40dB	3.76
		AAN 65...50dB	3.76
		AAN 75...60dB	3.76
		Capacitive Voltage Probe	3.04
		RF Current Probe	2.58

E. Harmonic current emissions / Voltage changes, voltage fluctuations and flicker measurement:

Test Site	Method	Measurement Frequency Range	U, (dB)
DG-C01	EN 61000-3-2	Voltage	0.774
	EN 61000-3-3	Current	0.782

F. Immunity Measurement:

Test Site	Method	Measurement Frequency Range	U, (dB)
DG-SR02	EN 61000-4-2	Voltage(2kV/4kV/6kV/8kV/15kV/25kV/30kV)	1.0%
		Peak Current	6.0%
		30/60ns Current	6.0%
		Rise time	6.4%
DG-CB05	EN 61000-4-3	80MHz~1GHz	2.175 dB
DG-SR05	EN 61000-4-4	Impulse Voltage	4.0 %
		Impulse Rise Time	4.5 %
		Impulse duration Time	4.0 %
DG-SR05	EN 61000-4-5	Impulse Voltage	4.0 %
		Impulse Rise Time	4.5 %
		Impulse duration Time	4.0 %
DG-CB06	EN 61000-4-6	CDN: 150kHz~230MHz	2.509 dB
		EM Clamp: 150kHz~230MHz	3.094 dB
DG-SR05	EN 61000-4-8	Magnetic Field Level	3 %
DG-SR05	EN 61000-4-11	Impulse Amplitude	4 %
		Timing	3 %

Note: Unless specifically mentioned, the uncertainty of measurement has not been taken into account to declare the compliance or non-compliance to the specification.

3. GENERAL INFORMATION

3.1 GENERAL DESCRIPTION OF EUT

Equipment	IP Phone
Brand Name	Fanvil
Test Model	X5S
Model Difference	N/A
Power Source	1. Supplied form PoE. 2. DC Voltage supplied from AC/DC adapter. Model: F12DE1200100A Manufacturer: Shenzhen Sunlight Electronic Technology Co., Ltd
Power Rating	1. DC48V 2. I/P: AC100-240V 50/60Hz 0.5A max O/P: DC12V 1.0A
Connecting I/O Port	USB port,DC port, Internet port, PC port, Headphone port, Handset port.

Note:

1. For a more detailed features description, please refer to the manufacturer’s specifications or the user's manual.

3.2 DESCRIPTION OF TEST MODES

To investigate the maximum EMI emission characteristics generates from EUT, the test system was pre-scanning tested base on the consideration of following EUT operation mode or test configuration mode which possible have effect on EMI emission level. Each of these EUT operation mode(s) or test configuration mode(s) mentioned above was evaluated respectively.

Pretest Mode	Description
Mode 1	Handfree
Mode 2	Handset
Mode 3	Headphone
Mode 4	PC Port 1Gbps
Mode 5	PC Port 100Mbps
Mode 6	PC Port 10Mbps
Mode 7	Internet Port 1Gbps
Mode 8	Internet Port 100Mbps
Mode 9	Internet Port 10Mbps

For Radiated Test	
Final Test Mode	Description
Mode 1	Handfree
Mode 2	Handset
Mode 3	Headphone

For Conducted Test	
Final Test Mode	Description
Mode 1	Handfree
Mode 2	Handset
Mode 3	Headphone

For ISN Test	
Final Test Mode	Description
Mode 4	PC Port 1Gbps
Mode 5	PC Port 100Mbps
Mode 6	PC Port 10Mbps
Mode 7	Internet Port 1Gbps
Mode 8	Internet Port 100Mbps
Mode 9	Internet Port 10Mbps

For Harmonics / Flicks Test	
Final Test Mode	Description
Mode 3	Headphone

For EMS Test	
Final Test Mode	Description
Mode 1	Handfree
Mode 2	Handset
Mode 3	Headphone

3.3 EUT OPERATING CONDITIONS

The EUT exercise program used during radiated and/or conducted emission measurement was designed to exercise the various system components in a manner similar to a typical use. The standard test signals and output signal as following:

1. EUT connected to notebook, IP Phone and PoE switch via RJ45 cable.
2. EUT connected to head phone via RJ11 cable.
3. PoE switch connected to IP Phone and adapter via RJ11&DC cable.

3.4 BLOCK DIAGRAM SHOWING THE CONFIGURATION OF SYSTEM TESTED

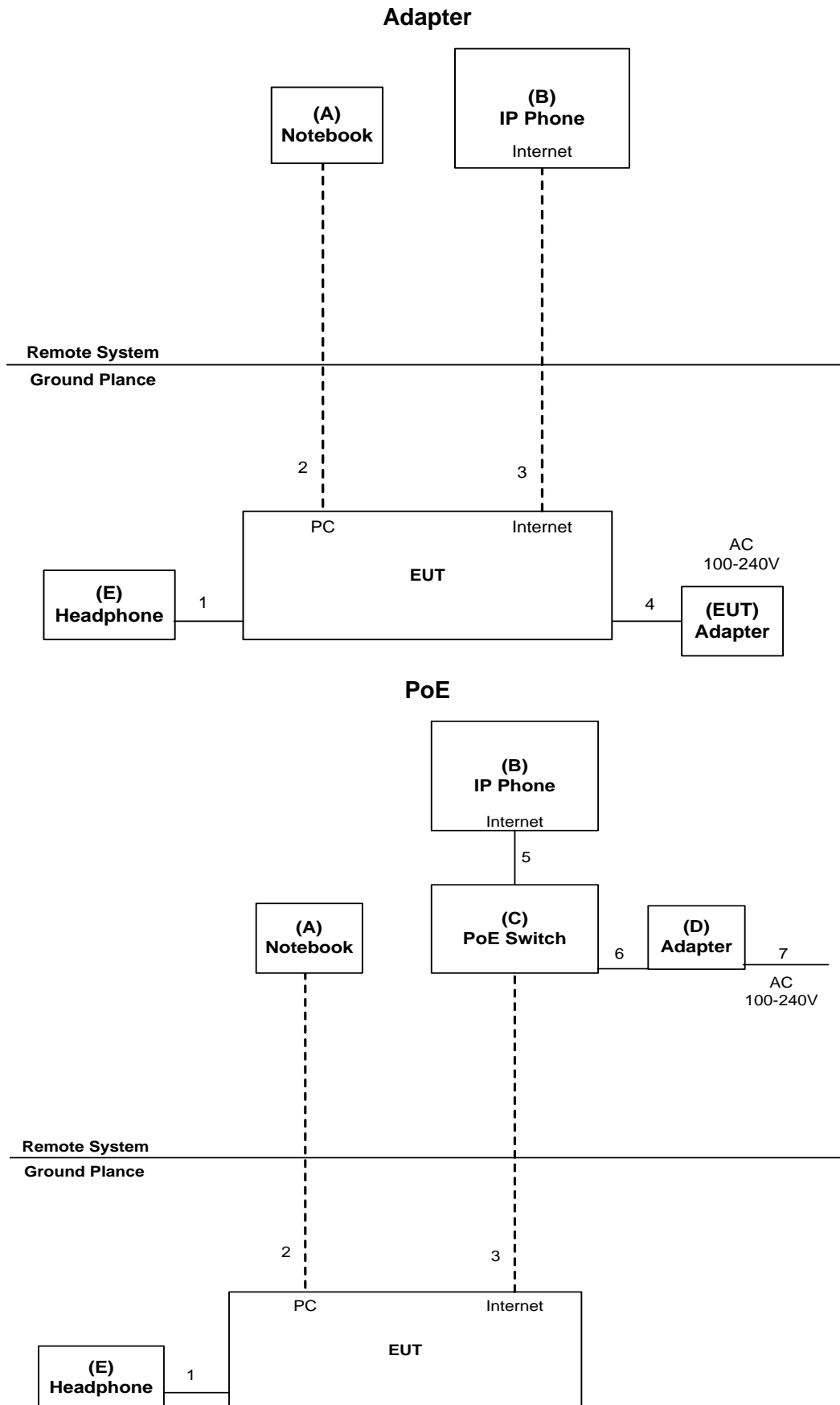

3.5 DESCRIPTION OF SUPPORT UNITS

The EUT has been tested as an independent unit together with other necessary accessories or support units. The following support units or accessories were used to form a representative test configuration during the tests.

Item	Equipment	Mfr/Brand	Model/Type No.	FCC ID	Series No.
A	Notebook	Lenovo	G40	DOC	YB09261386
B	IP Phone	Fanvil	X3SP	N/A	1000HF7371004260
C	PoE Switch	Fanvil	DGS-1008P/Dlink	N/A	N/A
D	Adapter	Leader	NU60-F4B0125-I1NN	N/A	N/A
E	Headphone	Fanvil	A310QD	N/A	N/A

Item	Shielded Type	Ferrite Core	Length	Note
1	NO	NO	1m	RJ11 Cable
2	NO	NO	10m	RJ45 Cable
3	NO	NO	10m	RJ45 Cable
4	NO	NO	1.5m	DC Cable
5	NO	NO	1.8m	RJ45 Cable
6	NO	YES	1.5m	DC Cable
7	NO	NO	1.8m	AC Cable

4. EMC EMISSION TEST

4.1 RADIATED EMISSION

4.1.1 LIMITS

Class A equipment up to 1000MHz

Table clause	Frequency range MHz	Measurement			Class A limits dB(μ V/m)
		Facility (see Table A.1)	Distance m	Detector type/ bandwidth	
A2.1	30-230	OATS/SAC	10	Quasi peak / 120 kHz	40
	230-1000				47
A2.2	30-230	OATS/SAC	3		50
	230-1000				57
A2.3	30-230	FAR	10	42 to 35	
	230-1000			42	
A2.4	30-230	FAR	3	52 to 45	
	230-1000			52	

Apply only A2.1 or A2.2 or A2.3 or A2.4 across the entire frequency range.

Class A equipment above 1000MHz

Table clause	Frequency range MHz	Measurement			Class A limits dB(μ V/m)
		Facility (see Table A.1)	Distance m	Detector type/bandwidth	
A3.1	1000-3000	FSOATS	3	Average / 1 MHz	56
	3000-6000				60
A3.2	1000-3000			Peak / 1 MHz	76
	3000-6000				80

Apply A3.1 and A3.2 across the frequency range from 1 000 MHz to the highest required frequency of measurement derived from Table 1.

Class B equipment up to 1000MHz

Table clause	Frequency range MHz	Measurement			Class B limits dB(μV/m)
		Facility (see Table A.1)	Distance m	Detector type/ bandwidth	
A4.1	30-230	OATS/SAC	10	Quasi peak / 120 kHz	30
	230-1000				37
A4.2	30-230	OATS/SAC	3		40
	230-1000				47
A4.3	30-230	FAR	10	32 to 25	
	230-1000			32	
A4.4	30-230	FAR	3	42 to 35	
	230-1000			42	

Apply only table clause A4.1 or A4.2 or A4.3 or A4.4 across the entire frequency range. These requirements are not applicable to the local oscillator and harmonics frequencies of equipment covered by Table A.6.

Class B equipment above 1000MHz

Table clause	Frequency range MHz	Measurement			Class B limits dB(μV/m)
		Facility (see Table A.1)	Distance m	Detector type/ bandwidth	
A5.1	1000-3000	FSOATS	3	Average / 1 MHz	50
	3000-6000				54
A5.2	1000-3000			Peak / 1 MHz	70
	3000-6000				74

Apply A5.1 and A5.2 across the frequency range from 1 000 MHz to the highest required frequency of measurement derived from Table 1.

Notes:

- (1) The limit for radiated test was performed according to as following: EN 55032
- (2) The tighter limit applies at the band edges.
- (3) Emission level (dBuV/m)=20log Emission level (uV/m).
- (4) The test result calculated as following:
 Measurement Value = Reading Level + Correct Factor
 Correct Factor = Antenna Factor + Cable Loss - Amplifier Gain(if use)
 Margin Level = Measurement Value - Limit Value

Required highest frequency for radiated measurement

Highest internal frequency (F _x) MHz	Highest measured frequency MHz
F _x ≤ 108	1000
108 < F _x ≤ 500	2000
500 < F _x ≤ 1000	5000
F _x > 1000	5 th up to a maximum 6 GHz,

Note for FM and TV broadcast receiver, F_x is determined from the highest frequency generated or used excluding the local oscillator and tuned frequencies.

4.1.2 MEASUREMENT INSTRUMENTS LIST

Up to 1GHz:

Item	Kind of Equipment	Manufacturer	Type No.	Serial No.	Calibrated until
1	Attenuator	N/A	SA18N-06	6dB	Apr. 14, 2018
2	Attenuator	N/A	SA18N-06	6dB	Apr. 14, 2018
3	Receiver	Keysight	N9038A	MY54450004	Sep. 04, 2017
4	MXE EMI Receiver	Agilent	N9038A	MY53220133	Jun. 20, 2018
5	Pre-Amplifier	Mini-Circuits	EMC 9135	980284	Mar. 26, 2018
6	Pre-Amplifier	Mini-Circuits	EMC 9135	980283	Mar. 26, 2018
7	Trilog-Broadband Antenna	Schwarzbeck	VULB9168	586	Mar. 26, 2018
8	Trilog-Broadband Antenna	Schwarzbeck	VULB9168	587	Mar. 26, 2018
9	Cable	emci	LMR-400(5 m+11m+15 m)	N/A	Dec. 27, 2017
10	Cable	emci	LMR-400(5 m+8m+15 m)	N/A	Dec. 27, 2017
11	Measurement Software	Farad	EZ-EMC Ver.BTL-2A NT-1	N/A	N/A
12	Multi-Device Controller	ETS-Lindgren	2090	N/A	N/A

Remark: "N/A" denotes no model name, no serial no. or no calibration specified.
All calibration period of equipment list is one year.

Above 1GHz:

Item	Kind of Equipment	Manufacturer	Type No.	Serial No.	Calibrated until
1	Horn Antenna	EMCO	3115	9605-4803	Mar. 26, 2018
2	Broad-Band Horn Antenna	Schwarzbeck	BBHA 9170	9170319	Jun. 08, 2018
3	Amplifier	Agilent	8449B	3008A02584	Sep. 04, 2017
4	Microwave Preamplifier With Adaptor	EMC INSTRUMENT	EMC2654045	980039 & HA01	Mar. 26, 2018
5	MXE EMI Receiver	Agilent	N9038A	MY53220133	Jun. 20, 2018
6	Measurement Software	Farad	EZ-EMC Ver.BTL-2AN T-1	N/A	N/A
7	Cable	emci	SUCOFLEX_15m_5m(0.01 GHz – 26.5GHz)	N/A	Dec. 27, 2017
8	Multi-Device Controller	ETS-Lindgren	2090	N/A	N/A
9	Controller	MF	MF-7802	MF780208159	N/A
10	Cable	emci	SUCOFLEX 102_8m(0.01 GHz – 40GHz)	N/A	Mar. 27, 2018

Remark: "N/A" denotes no model name, no serial no. or no calibration specified.

All calibration period of equipment list is one year.

4.1.3 TEST PROCEDURE

- a. The measuring distance of 10 m shall be used for measurements. The EUT was placed on the top of a rotating table 0.8 meter above the ground at a 10 meter semi-anechoic chamber. The table was rotated 360 degrees to determine the position of the highest radiation.(below 1GHz).
- b. The measuring distance of 3 m shall be used for measurements. The EUT was placed on the top of a rotating table 0.8 meter above the ground at a 10 meter semi-anechoic chamber. The table was rotated 360 degrees to determine the position of the highest radiation.(above 1GHz)
- c. The height of the equipment or of the substitution antenna shall be 0.8 m, the height of the test antenna shall vary between 1 m to 4 m. Both horizontal and vertical polarizations of the antenna are set to make the measurement.
- d. The initial step in collecting radiated emission data is a receiver peak detector mode pre-scanning the measurement frequency range. Significant peaks are then marked and then Quasi Peak detector mode re-measured.
- e. All readings are Peak unless otherwise stated QP in column of Note. Peak denotes that the Peak reading compliance with the QP Limits and then QP Mode measurement didn't perform. (below 1GHz)
- f. All readings are Peak Mode value unless otherwise stated AVG in column of Note. If the Peak Mode Measured value compliance with the Peak Limits and lower than AVG Limits, the EUT shall be deemed to meet both Peak & AVG Limits and then only Peak Mode was measured, but AVG Mode didn't perform. (above 1GHz)
- g. For the actual test configuration, please refer to the related Item - Block Diagram of system tested (please refer to 3.3).

4.1.4 DEVIATION FROM TEST STANDARD

No deviation

4.1.5 TEST SETUP

UP TO 1 GHZ

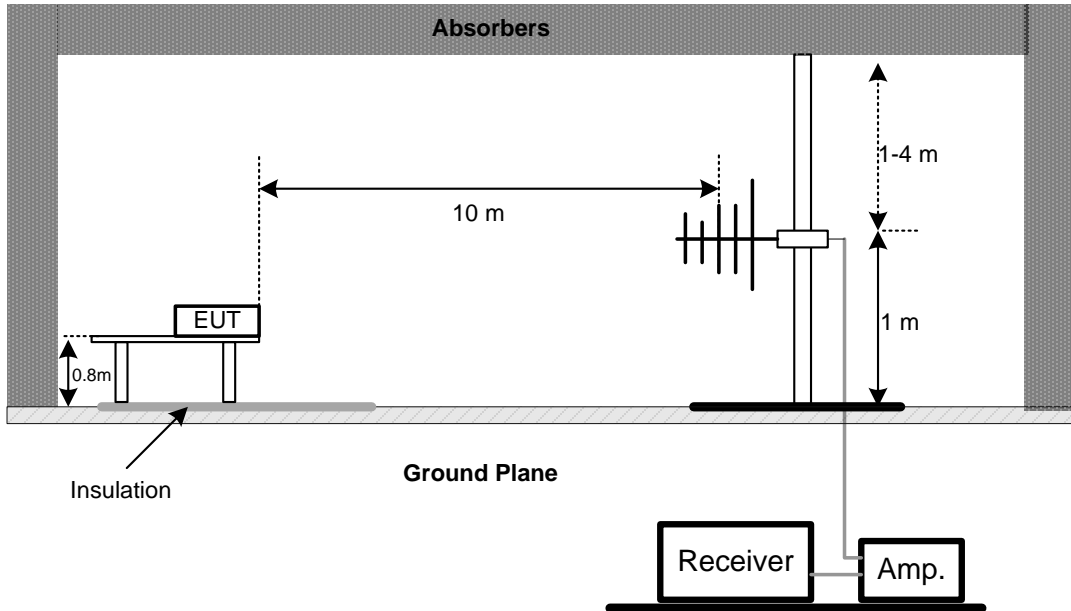

Note: The antenna can be moved between 1 to 4 meters above the ground.

ABOVE 1 GHZ

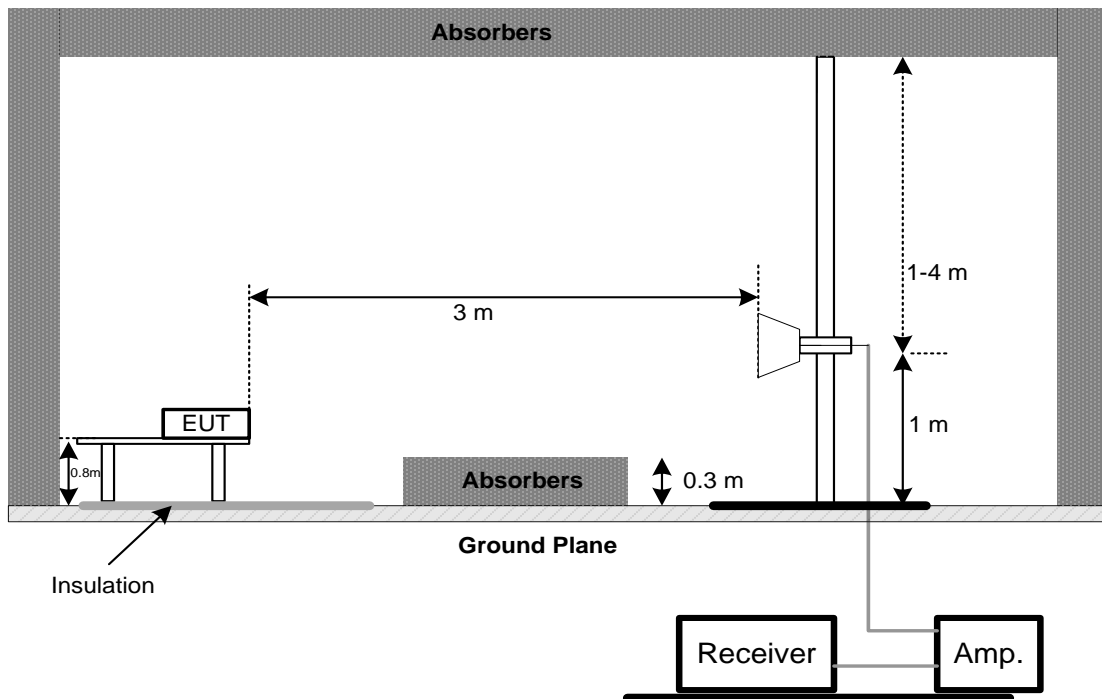

4.1.6 MEASUREMENT DISTANCE

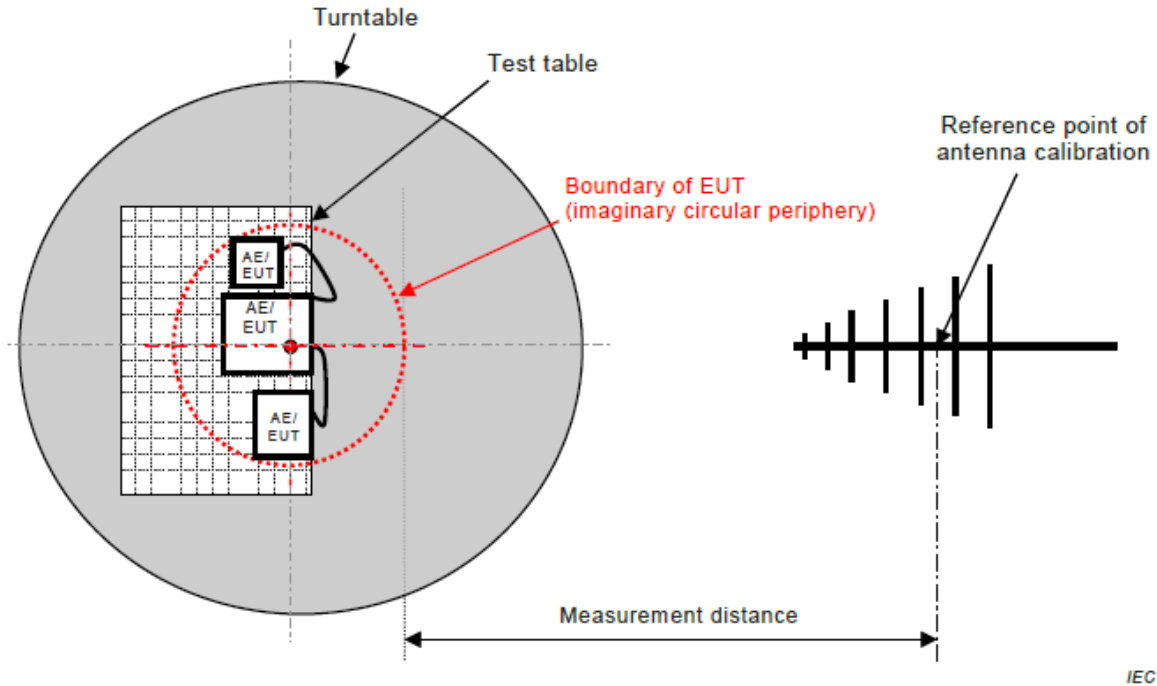

Figure C.1 – Measurement distance

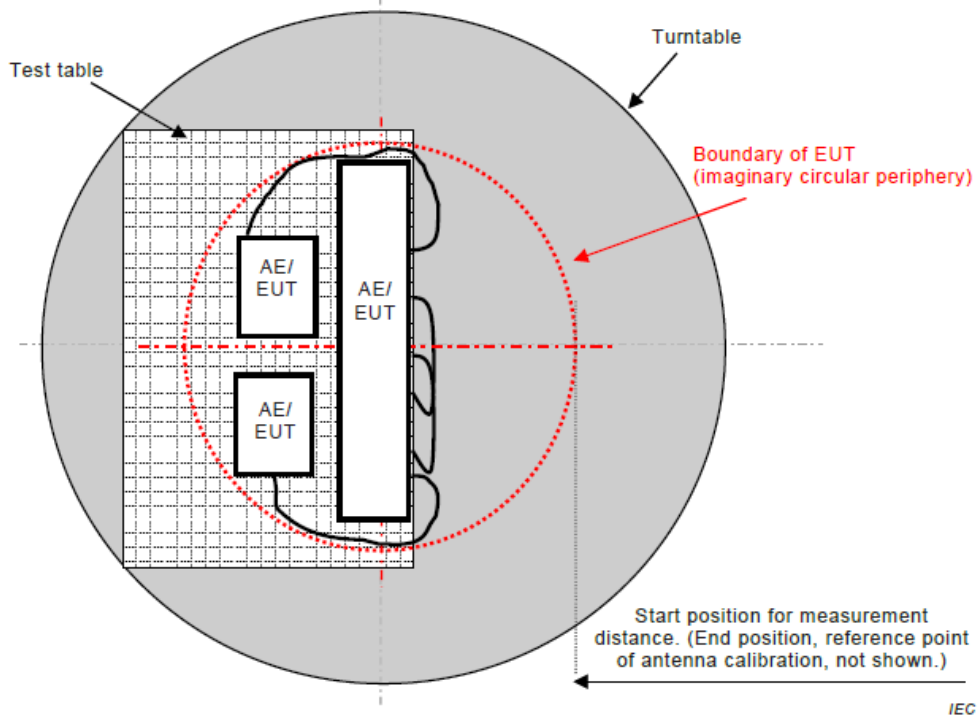
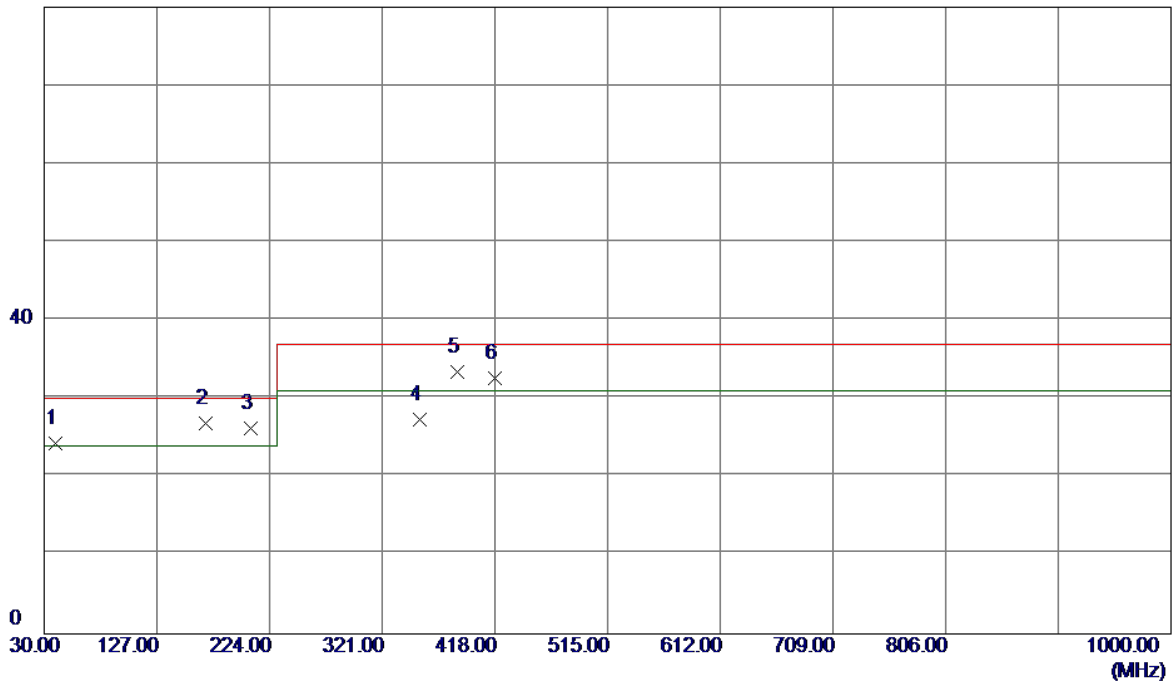

Figure C.2 – Boundary of EUT, Local AE and associated cabling

4.1.7 TEST RESULTS (UP TO 1 GHZ)

EUT	IP Phone	Model Name	X5S
Temperature	25°C	Relative Humidity	60%
Test Voltage	AC 230V/50Hz	Polarization	Vertical
Test Mode	Handfree		
Note	Adapter		
Test Engineer	Jason Yang		

80 dBuV/m



No.	Freq. MHz	Reading Level dBuV/m	Correct Factor dB	Measure ment dBuV/m	Limit dBuV/m	Margin dB	Detector
1	39.7000	47.70	-23.36	24.34	30.00	-5.66	QP
2 *	169.1950	48.51	-21.63	26.88	30.00	-3.12	QP
3	207.5100	50.01	-23.83	26.18	30.00	-3.82	QP
4	353.4950	46.14	-18.72	27.42	37.00	-9.58	QP
5	385.9900	51.28	-17.78	33.50	37.00	-3.50	QP
6	418.0000	49.28	-16.71	32.57	37.00	-4.43	QP

EUT	IP Phone	Model Name	X5S
Temperature	25°C	Relative Humidity	60%
Test Voltage	AC 230V/50Hz	Polarization	Horizontal
Test Mode	Handfree		
Note	Adapter		
Test Engineer	Jason Yang		

80 dBuV/m

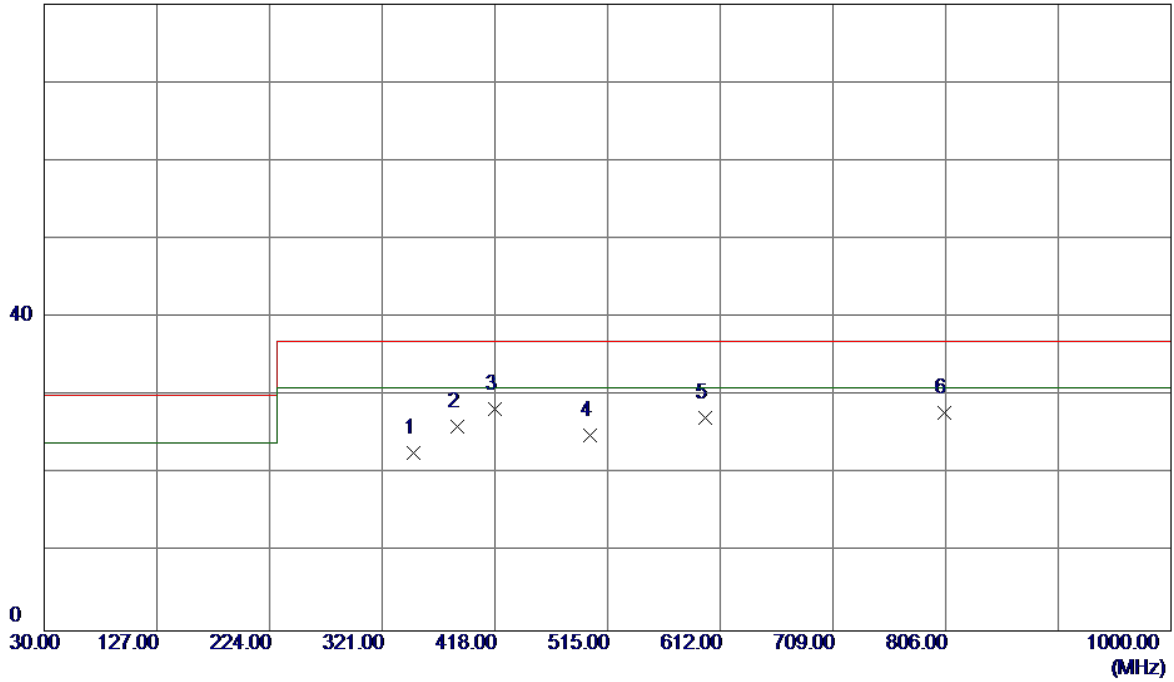

No.	Freq. MHz	Reading Level dBuV/m	Correct Factor dB	Measure ment dBuV/m	Limit dBuV/m	Margin dB	Detector
1	348.1600	41.03	-18.36	22.67	37.00	-14.33	QP
2	385.9900	43.32	-17.23	26.09	37.00	-10.91	QP
3 *	418.0000	44.54	-16.15	28.39	37.00	-8.61	QP
4	499.4800	38.96	-14.06	24.90	37.00	-12.10	QP
5	599.3900	39.18	-12.04	27.14	37.00	-9.86	QP
6	805.0300	36.62	-8.78	27.84	37.00	-9.16	QP

EUT	IP Phone	Model Name	X5S
Temperature	25°C	Relative Humidity	60%
Test Voltage	DC 48V	Polarization	Vertical
Test Mode	Handfree		
Note	PoE		
Test Engineer	Jason Yang		

80 dBuV/m

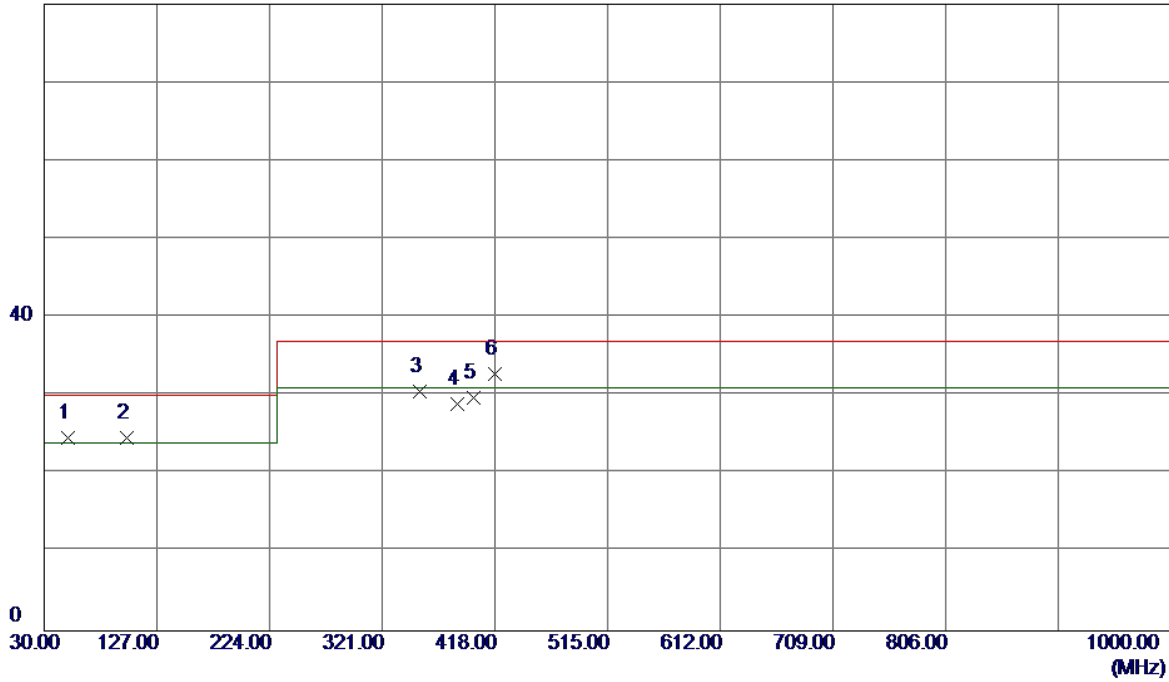

No.	Freq. MHz	Reading Level dBuV/m	Correct Factor dB	Measure ment dBuV/m	Limit dBuV/m	Margin dB	Detector
1	50.8550	46.91	-22.24	24.67	30.00	-5.33	QP
2	101.2950	50.71	-26.03	24.68	30.00	-5.32	QP
3	353.4950	49.23	-18.72	30.51	37.00	-6.49	QP
4	385.5050	46.72	-17.79	28.93	37.00	-8.07	QP
5	400.0550	47.18	-17.37	29.81	37.00	-7.19	QP
6 *	418.0000	49.51	-16.71	32.80	37.00	-4.20	QP

EUT	IP Phone	Model Name	X5S
Temperature	25°C	Relative Humidity	60%
Test Voltage	DC 48V	Polarization	Horizontal
Test Mode	Handfree		
Note	PoE		
Test Engineer	Jason Yang		

80 dBuV/m

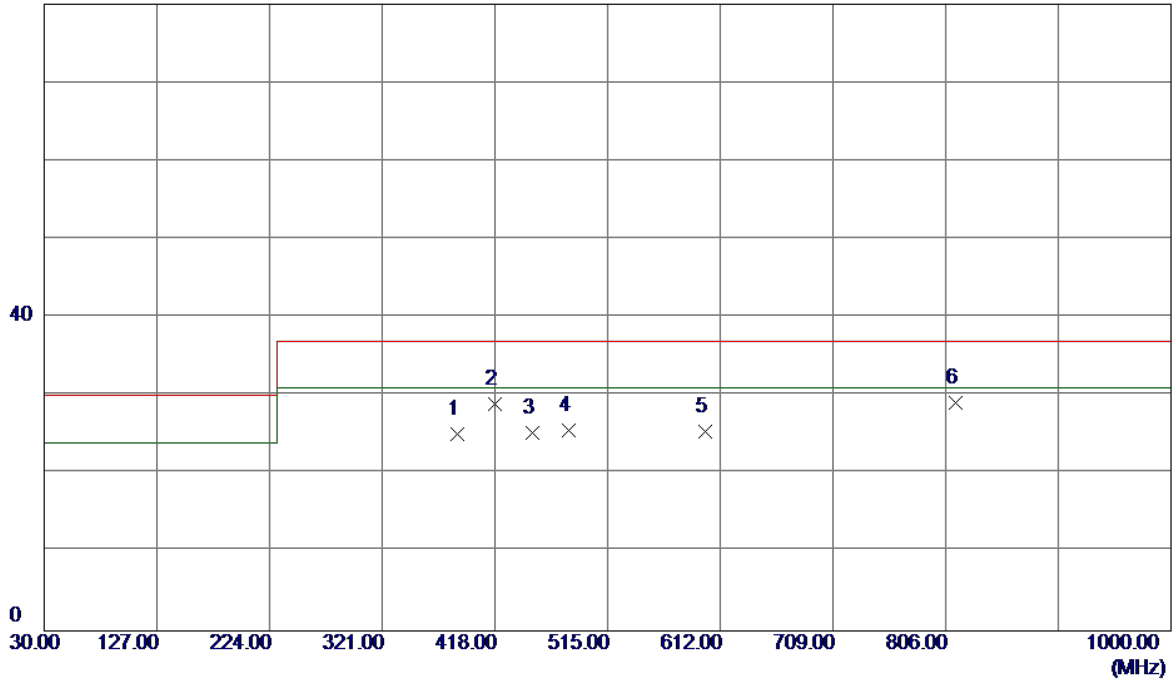

No.	Freq. MHz	Reading Level dBuV/m	Correct Factor dB	Measure ment dBuV/m	Limit dBuV/m	Margin dB	Detector
1	385.9900	42.39	-17.23	25.16	37.00	-11.84	QP
2	418.0000	45.07	-16.15	28.92	37.00	-8.08	QP
3	450.0100	40.26	-14.99	25.27	37.00	-11.73	QP
4	482.0200	39.98	-14.39	25.59	37.00	-11.41	QP
5	599.3900	37.45	-12.04	25.41	37.00	-11.59	QP
6 *	814.7300	37.81	-8.65	29.16	37.00	-7.84	QP

EUT	IP Phone	Model Name	X5S
Temperature	25°C	Relative Humidity	60%
Test Voltage	AC 230V/50Hz	Polarization	Vertical
Test Mode	Handset		
Note	Adapter		
Test Engineer	Jason Yang		

80 dBuV/m

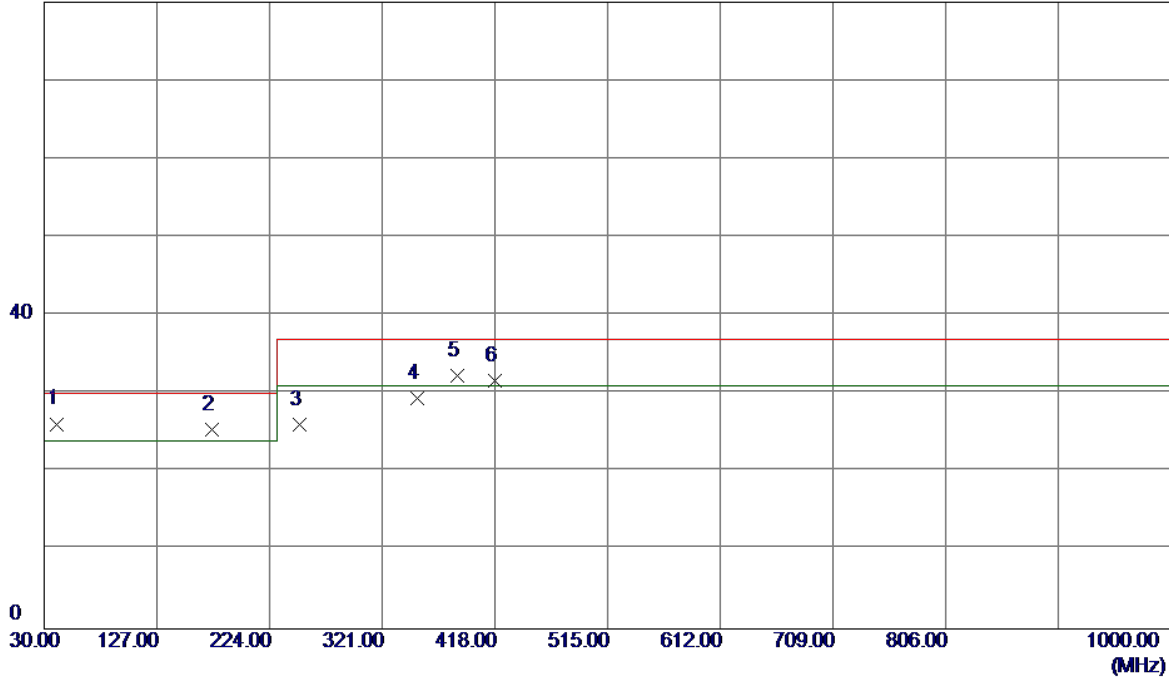

No.	Freq. MHz	Reading Level dBuV/m	Correct Factor dB	Measure ment dBuV/m	Limit dBuV/m	Margin dB	Detector
1 *	40.6699	49.39	-23.23	26.16	30.00	-3.84	QP
2	174.0450	47.54	-22.04	25.50	30.00	-4.50	QP
3	250.1900	47.84	-21.79	26.05	37.00	-10.95	QP
4	351.0700	48.29	-18.79	29.50	37.00	-7.50	QP
5	385.9900	50.07	-17.78	32.29	37.00	-4.71	QP
6	418.0000	48.42	-16.71	31.71	37.00	-5.29	QP

EUT	IP Phone	Model Name	X5S
Temperature	25°C	Relative Humidity	60%
Test Voltage	AC 230V/50Hz	Polarization	Horizontal
Test Mode	Handset		
Note	Adapter		
Test Engineer	Jason Yang		

80 dBuV/m

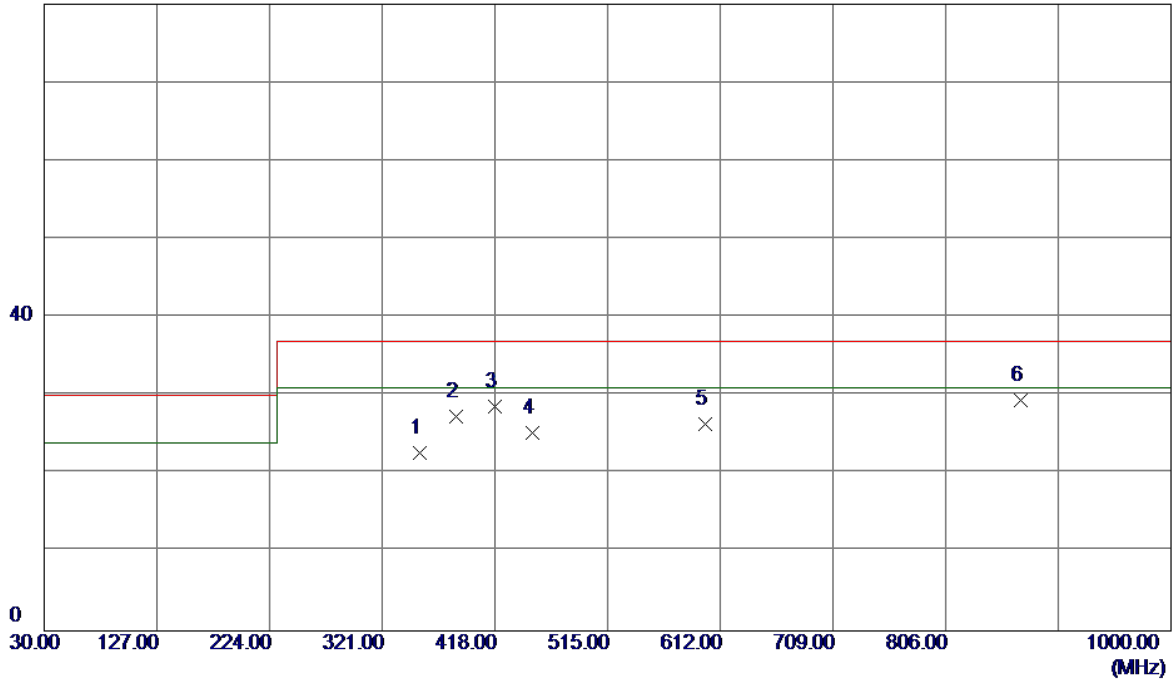

No.	Freq. MHz	Reading Level dBuV/m	Correct Factor dB	Measure ment dBuV/m	Limit dBuV/m	Margin dB	Detector
1	353.0100	40.89	-18.23	22.66	37.00	-14.34	QP
2	385.0200	44.57	-17.26	27.31	37.00	-9.69	QP
3	418.0000	44.78	-16.15	28.63	37.00	-8.37	QP
4	450.0100	40.34	-14.99	25.35	37.00	-11.65	QP
5	599.3900	38.44	-12.04	26.40	37.00	-10.60	QP
6 *	870.9900	37.23	-7.84	29.39	37.00	-7.61	QP

EUT	IP Phone	Model Name	X5S
Temperature	25°C	Relative Humidity	60%
Test Voltage	DC 48V	Polarization	Vertical
Test Mode	Handset		
Note	PoE		
Test Engineer	Jason Yang		

80 dBuV/m

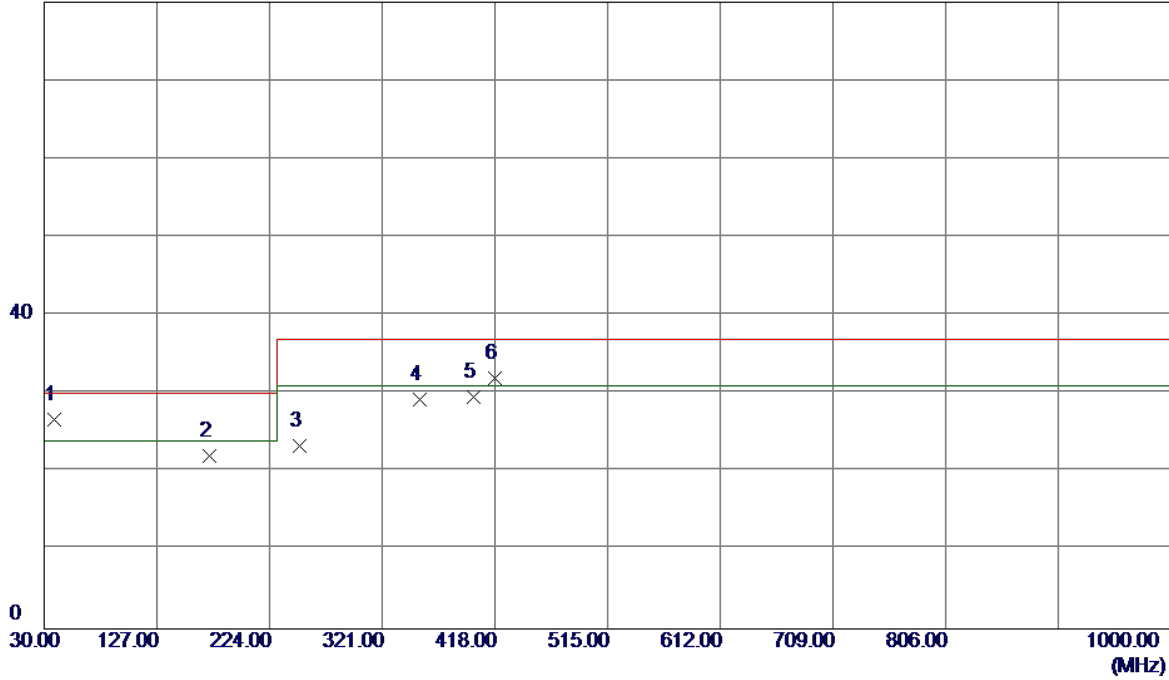

No.	Freq. MHz	Reading Level dBuV/m	Correct Factor dB	Measure ment dBuV/m	Limit dBuV/m	Margin dB	Detector
1 *	38.2450	50.26	-23.51	26.75	30.00	-3.25	QP
2	172.1050	43.96	-21.87	22.09	30.00	-7.91	QP
3	250.1900	45.15	-21.79	23.36	37.00	-13.64	QP
4	353.4950	48.02	-18.72	29.30	37.00	-7.70	QP
5	400.0550	47.03	-17.37	29.66	37.00	-7.34	QP
6	418.0000	48.76	-16.71	32.05	37.00	-4.95	QP

EUT	IP Phone	Model Name	X5S
Temperature	25°C	Relative Humidity	60%
Test Voltage	DC 48V	Polarization	Horizontal
Test Mode	Handset		
Note	PoE		
Test Engineer	Jason Yang		

80 dBuV/m

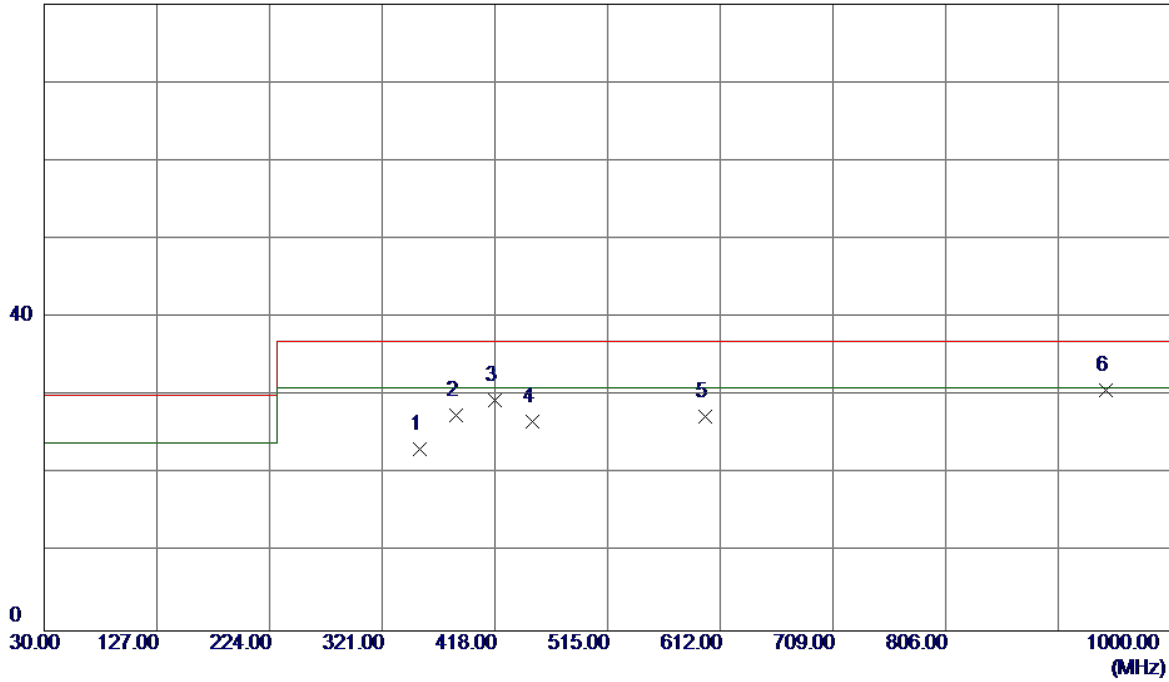

No.	Freq. MHz	Reading Level dBuV/m	Correct Factor dB	Measure ment dBuV/m	Limit dBuV/m	Margin dB	Detector
1	353.0100	41.42	-18.23	23.19	37.00	-13.81	QP
2	385.0200	44.77	-17.26	27.51	37.00	-9.49	QP
3	418.0000	45.58	-16.15	29.43	37.00	-7.57	QP
4	450.0100	41.73	-14.99	26.74	37.00	-10.26	QP
5	599.3900	39.34	-12.04	27.30	37.00	-9.70	QP
6 *	943.7400	37.14	-6.48	30.66	37.00	-6.34	QP

EUT	IP Phone	Model Name	X5S
Temperature	25°C	Relative Humidity	60%
Test Voltage	AC 230V/50Hz	Polarization	Vertical
Test Mode	Headphone		
Note	Adapter		
Test Engineer	Jason Yang		

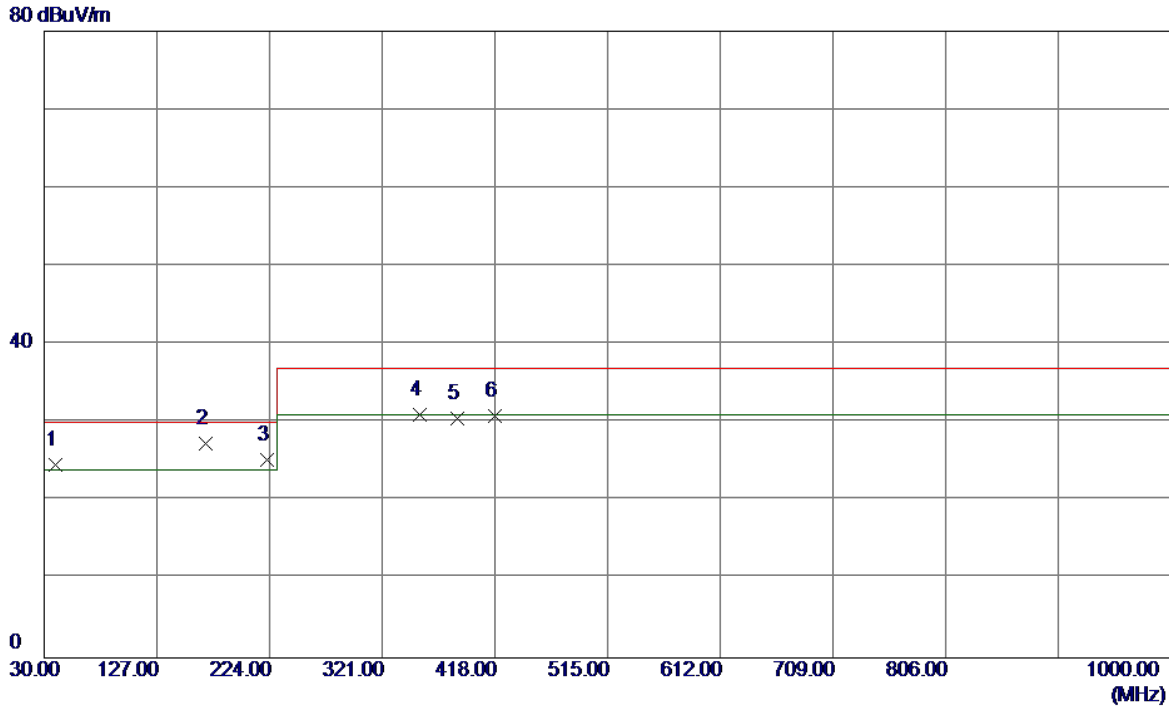

No.	Freq. MHz	Reading Level dBuV/m	Correct Factor dB	Measure ment dBuV/m	Limit dBuV/m	Margin dB	Detector
1	39.2150	48.10	-23.41	24.69	30.00	-5.31	QP
2 *	169.1950	49.05	-21.63	27.42	30.00	-2.58	QP
3	221.5750	49.10	-23.75	25.35	30.00	-4.65	QP
4	353.4950	49.77	-18.72	31.05	37.00	-5.95	QP
5	385.9900	48.29	-17.78	30.51	37.00	-6.49	QP
6	418.0000	47.64	-16.71	30.93	37.00	-6.07	QP

EUT	IP Phone	Model Name	X5S
Temperature	25°C	Relative Humidity	60%
Test Voltage	AC 230V/50Hz	Polarization	Horizontal
Test Mode	Headphone		
Note	Adapter		
Test Engineer	Jason Yang		

80 dBuV/m

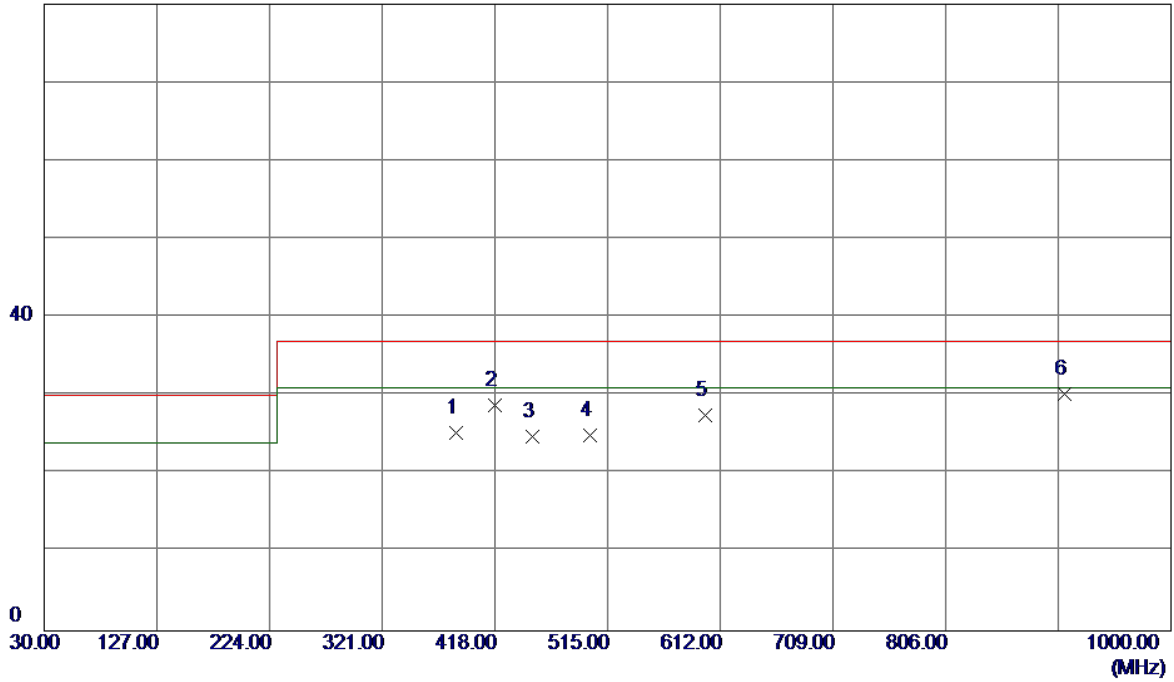

No.	Freq. MHz	Reading Level dBuV/m	Correct Factor dB	Measure ment dBuV/m	Limit dBuV/m	Margin dB	Detector
1	385.0200	42.54	-17.26	25.28	37.00	-11.72	QP
2	418.0000	44.92	-16.15	28.77	37.00	-8.23	QP
3	450.0100	39.79	-14.99	24.80	37.00	-12.20	QP
4	499.4800	39.04	-14.06	24.98	37.00	-12.02	QP
5	599.3900	39.55	-12.04	27.51	37.00	-9.49	QP
6 *	908.3350	37.43	-7.19	30.24	37.00	-6.76	QP

EUT	IP Phone	Model Name	X5S
Temperature	25°C	Relative Humidity	60%
Test Voltage	DC 48V	Polarization	Vertical
Test Mode	Headphone		
Note	PoE		
Test Engineer	Jason Yang		

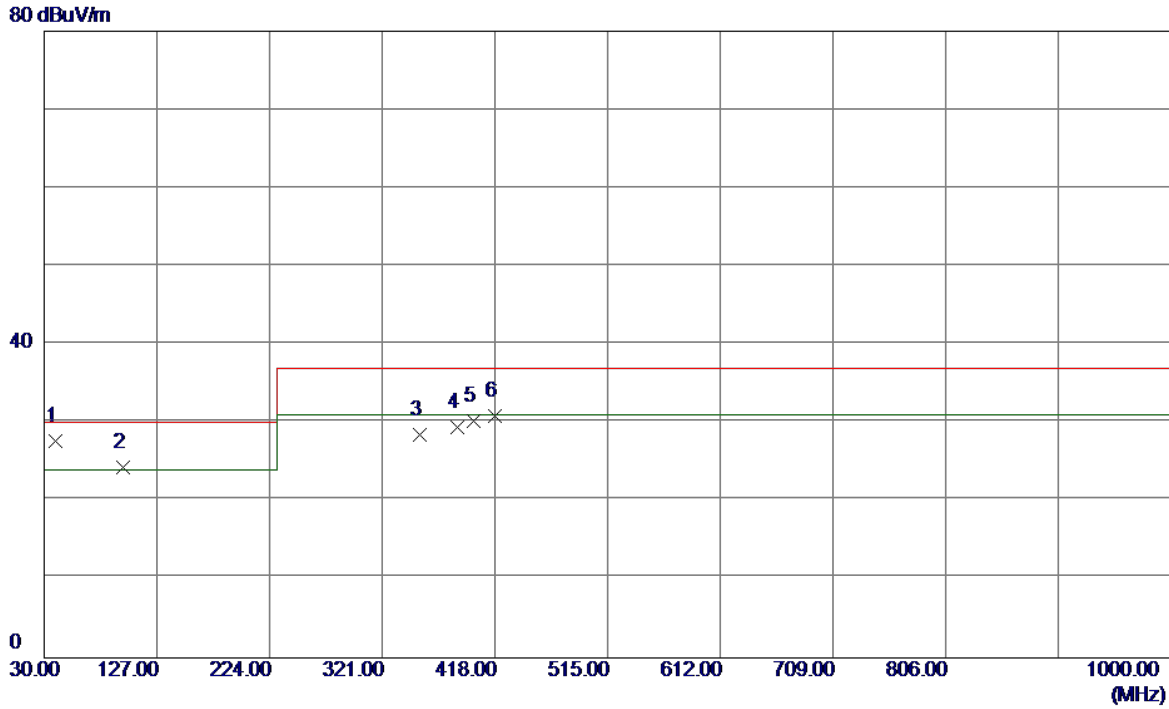

No.	Freq. MHz	Reading Level dBuV/m	Correct Factor dB	Measure ment dBuV/m	Limit dBuV/m	Margin dB	Detector
1 *	39.7000	51.02	-23.36	27.66	30.00	-2.34	QP
2	97.9000	50.81	-26.49	24.32	30.00	-5.68	QP
3	353.4950	47.23	-18.72	28.51	37.00	-8.49	QP
4	385.9900	47.21	-17.78	29.43	37.00	-7.57	QP
5	400.0550	47.66	-17.37	30.29	37.00	-6.71	QP
6	418.0000	47.52	-16.71	30.81	37.00	-6.19	QP

EUT	IP Phone	Model Name	X5S
Temperature	25°C	Relative Humidity	60%
Test Voltage	DC 48V	Polarization	Horizontal
Test Mode	Headphone		
Note	PoE		
Test Engineer	Jason Yang		

80 dBuV/m

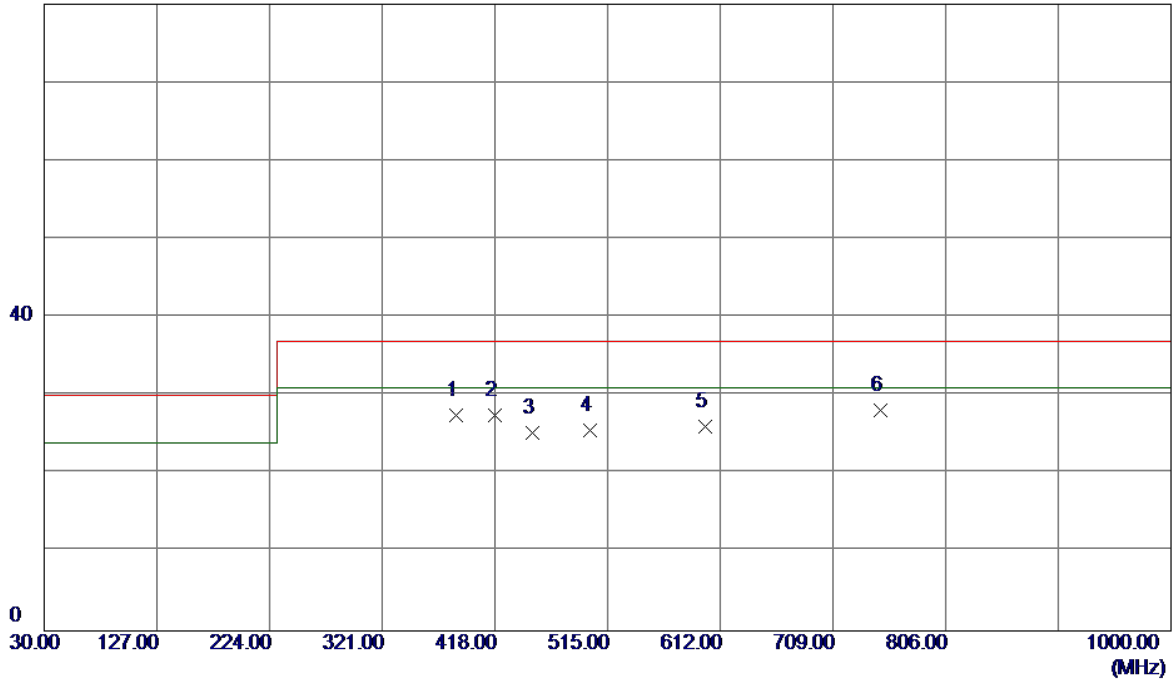

No.	Freq. MHz	Reading Level dBuV/m	Correct Factor dB	Measure ment dBuV/m	Limit dBuV/m	Margin dB	Detector
1	385.0200	44.78	-17.26	27.52	37.00	-9.48	QP
2	418.0000	43.64	-16.15	27.49	37.00	-9.51	QP
3	450.0100	40.31	-14.99	25.32	37.00	-11.68	QP
4	499.4800	39.67	-14.06	25.61	37.00	-11.39	QP
5	599.3900	38.19	-12.04	26.15	37.00	-10.85	QP
6 *	749.7400	37.55	-9.41	28.14	37.00	-8.86	QP

EUT	IP Phone	Model Name	X5S
Temperature	25°C	Relative Humidity	60%
Test Voltage	AC 110V/60Hz	Polarization	Vertical
Test Mode	Headphone		
Note	Adapter		
Test Engineer	Jason Yang		

80 dBuV/m

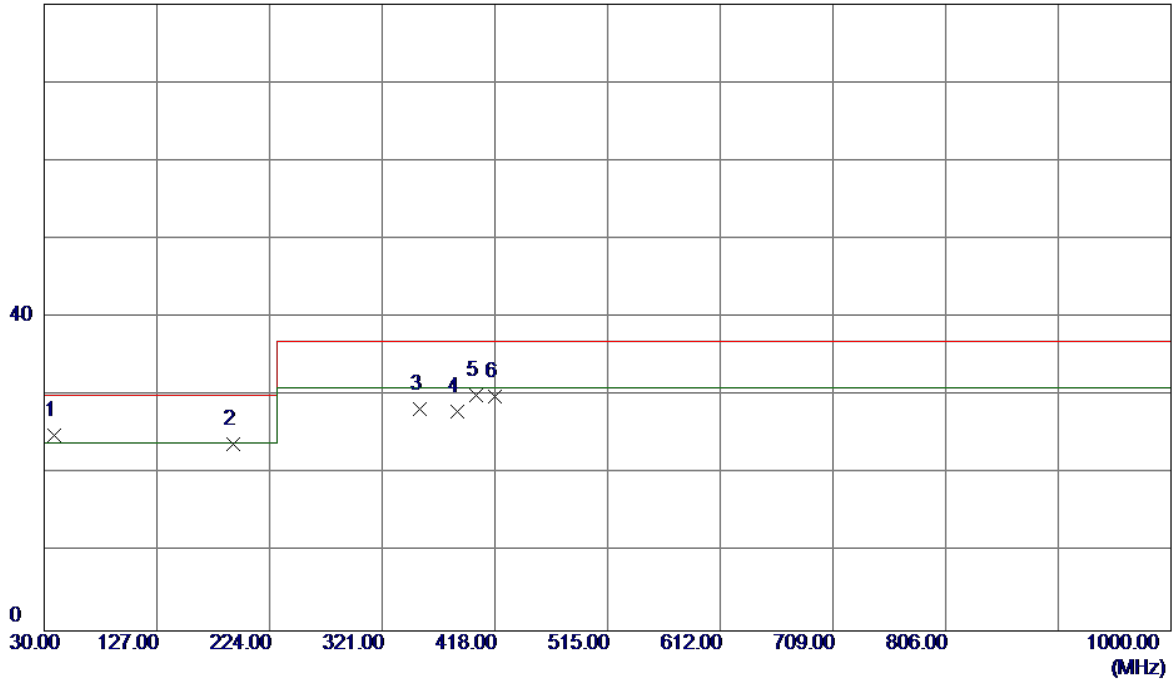

No.	Freq. MHz	Reading Level dBuV/m	Correct Factor dB	Measure ment dBuV/m	Limit dBuV/m	Margin dB	Detector
1 *	38.7300	48.39	-23.46	24.93	30.00	-5.07	QP
2	192.9600	47.42	-23.60	23.82	30.00	-6.18	QP
3	353.4950	47.04	-18.72	28.32	37.00	-8.68	QP
4	385.9900	45.78	-17.78	28.00	37.00	-9.00	QP
5	401.9950	47.34	-17.30	30.04	37.00	-6.96	QP
6	418.0000	46.57	-16.71	29.86	37.00	-7.14	QP

EUT	IP Phone	Model Name	X5S
Temperature	25°C	Relative Humidity	60%
Test Voltage	AC 110V/60Hz	Polarization	Horizontal
Test Mode	Headphone		
Note	Adapter		
Test Engineer	Jason Yang		

80 dBuV/m

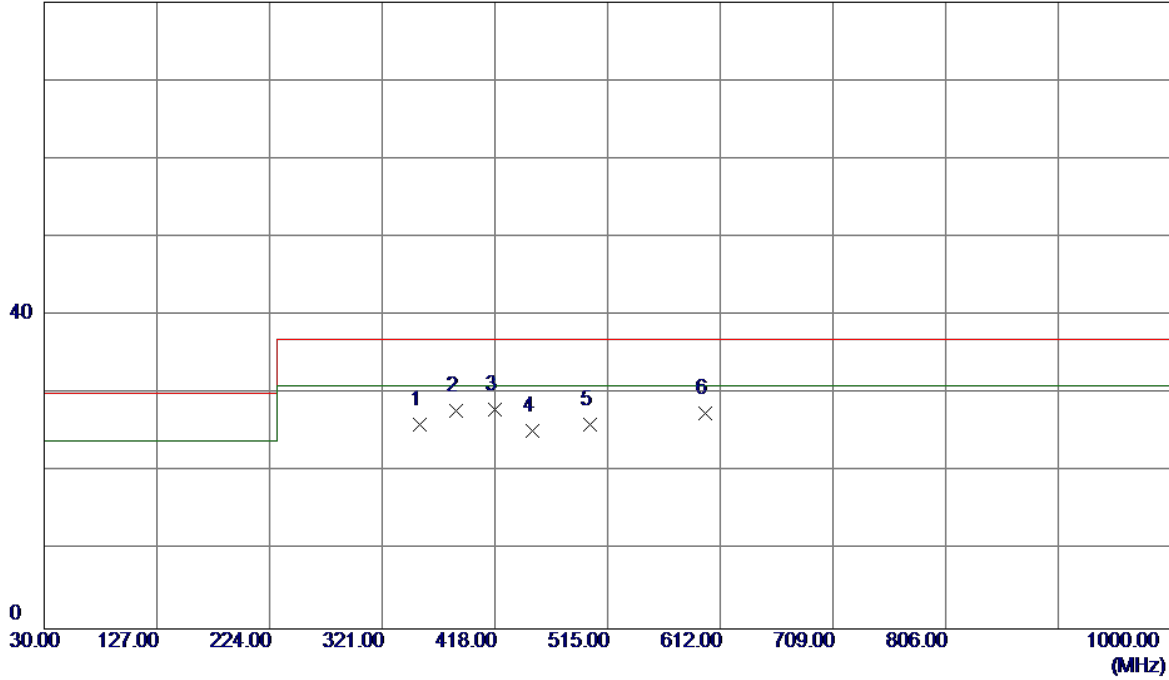

No.	Freq. MHz	Reading Level dBuV/m	Correct Factor dB	Measure ment dBuV/m	Limit dBuV/m	Margin dB	Detector
1	353.0100	44.26	-18.23	26.03	37.00	-10.97	QP
2	385.0200	45.15	-17.26	27.89	37.00	-9.11	QP
3 *	418.0000	44.17	-16.15	28.02	37.00	-8.98	QP
4	450.0100	40.33	-14.99	25.34	37.00	-11.66	QP
5	499.4800	40.19	-14.06	26.13	37.00	-10.87	QP
6	599.3900	39.50	-12.04	27.46	37.00	-9.54	QP

4.1.8 TEST RESULTS (ABOVE 1 GHZ)

EUT	IP Phone	Model Name	X5S
Temperature	25°C	Relative Humidity	60%
Test Voltage	AC 230V/50Hz	Polarization	Vertical
Test Mode	Handfree		
Note	Adapter		
Test Engineer	Jason Yang		

80 dBuV/m

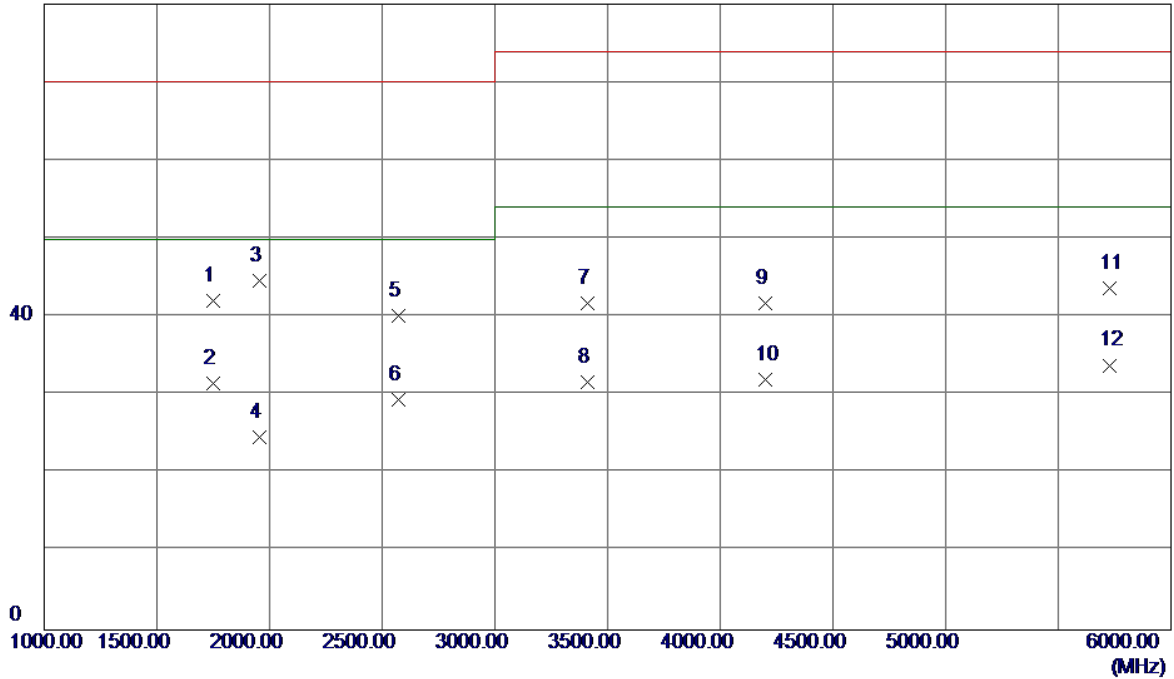

No.	Freq. MHz	Reading Level dBuV/m	Correct Factor dB	Measure ment dBuV/m	Limit dBuV/m	Margin dB	Detector
1	1750.0000	44.80	-2.67	42.13	70.00	-27.87	Peak
2 *	1750.0000	34.26	-2.67	31.59	50.00	-18.41	AVG
3	1955.0000	46.57	-1.92	44.65	70.00	-25.35	Peak
4	1955.0000	26.57	-1.92	24.65	50.00	-25.35	AVG
5	2570.0000	38.94	1.27	40.21	70.00	-29.79	Peak
6	2570.0000	28.14	1.27	29.41	50.00	-20.59	AVG
7	3412.5000	37.29	4.49	41.78	74.00	-32.22	Peak
8	3412.5000	27.25	4.49	31.74	54.00	-22.26	AVG
9	4197.5000	36.26	5.56	41.82	74.00	-32.18	Peak
10	4197.5000	26.37	5.56	31.93	54.00	-22.07	AVG
11	5727.5000	33.99	9.74	43.73	74.00	-30.27	Peak
12	5727.5000	24.10	9.74	33.84	54.00	-20.16	AVG

EUT	IP Phone	Model Name	X5S
Temperature	25°C	Relative Humidity	60%
Test Voltage	AC 230V/50Hz	Polarization	Horizontal
Test Mode	Handfree		
Note	Adapter		
Test Engineer	Jason Yang		

80 dBuV/m

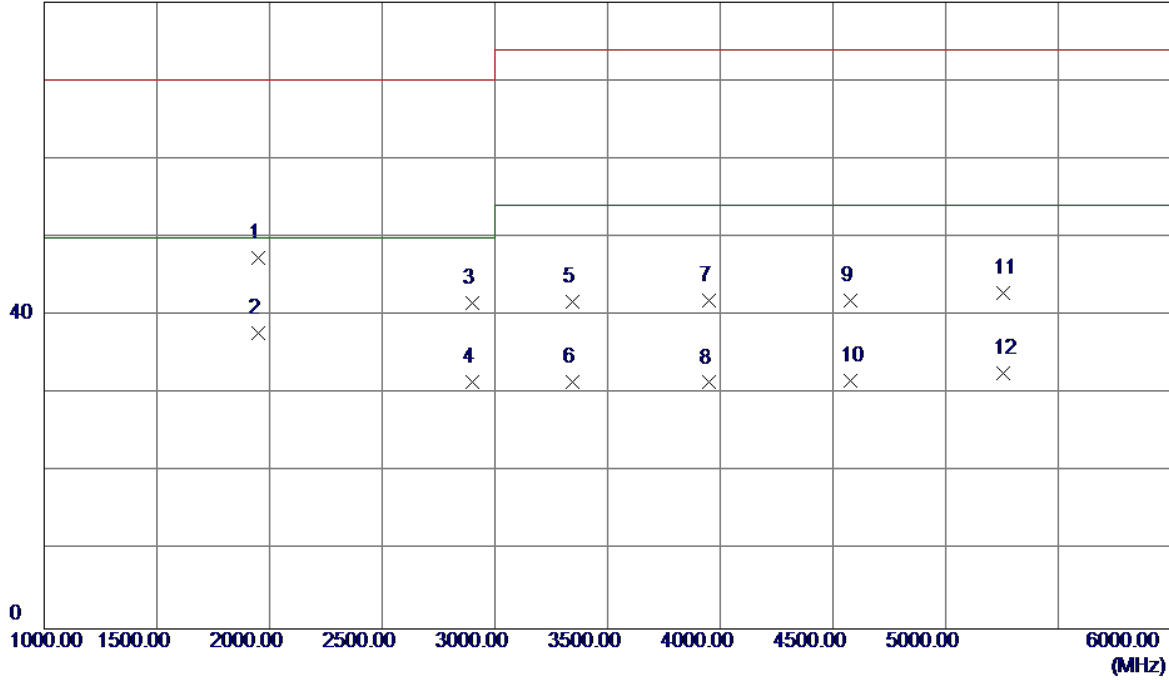

No.	Freq. MHz	Reading Level dBuV/m	Correct Factor dB	Measure ment dBuV/m	Limit dBuV/m	Margin dB	Detector
1	1950.0000	49.28	-1.94	47.34	70.00	-22.66	Peak
2 *	1950.0000	39.63	-1.94	37.69	50.00	-12.31	AVG
3	2897.5000	38.42	3.12	41.54	70.00	-28.46	Peak
4	2897.5000	28.44	3.12	31.56	50.00	-18.44	AVG
5	3342.5000	37.39	4.35	41.74	74.00	-32.26	Peak
6	3342.5000	27.13	4.35	31.48	54.00	-22.52	AVG
7	3952.5000	36.85	5.08	41.93	74.00	-32.07	Peak
8	3952.5000	26.36	5.08	31.44	54.00	-22.56	AVG
9	4577.5000	35.56	6.37	41.93	74.00	-32.07	Peak
10	4577.5000	25.36	6.37	31.73	54.00	-22.27	AVG
11	5257.5000	34.91	7.95	42.86	74.00	-31.14	Peak
12	5257.5000	24.64	7.95	32.59	54.00	-21.41	AVG

EUT	IP Phone	Model Name	X5S
Temperature	25°C	Relative Humidity	60%
Test Voltage	DC 48V	Polarization	Vertical
Test Mode	Handfree		
Note	PoE		
Test Engineer	Jason Yang		

80 dBuV/m

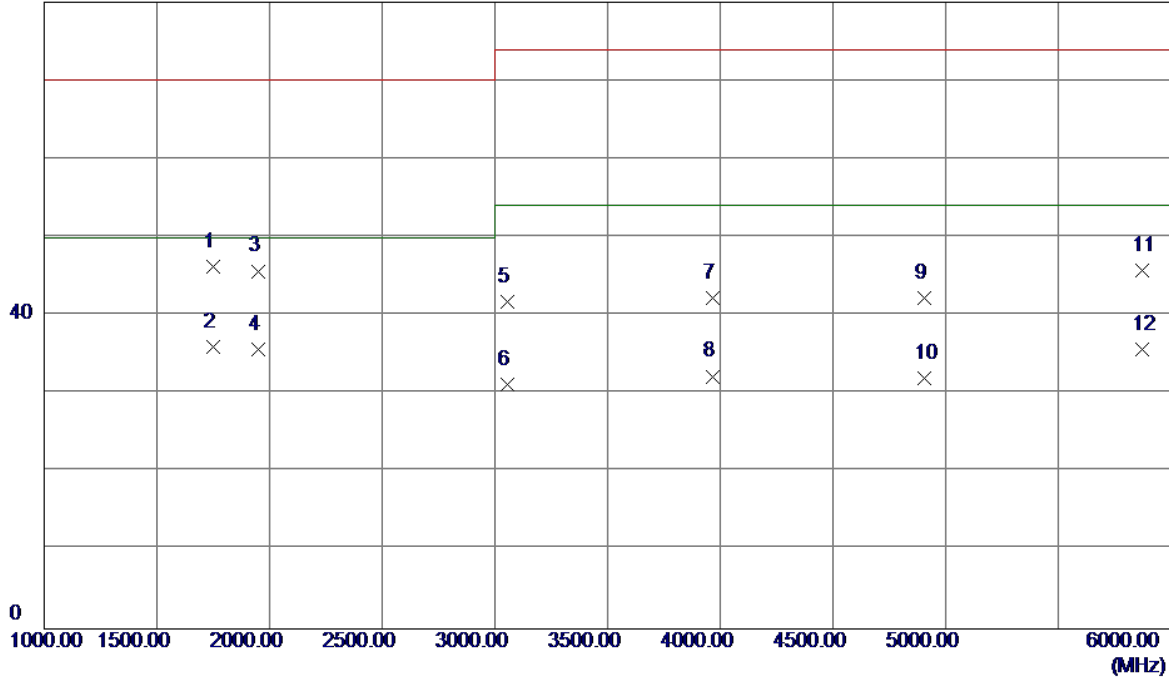

No.	Freq. MHz	Reading Level dBuV/m	Correct Factor dB	Measure ment dBuV/m	Limit dBuV/m	Margin dB	Detector
1	1752.5000	48.85	-2.66	46.19	70.00	-23.81	Peak
2 *	1752.5000	38.62	-2.66	35.96	50.00	-14.04	AVG
3	1952.5000	47.61	-1.93	45.68	70.00	-24.32	Peak
4	1952.5000	37.55	-1.93	35.62	50.00	-14.38	AVG
5	3055.0000	37.91	3.80	41.71	74.00	-32.29	Peak
6	3055.0000	27.45	3.80	31.25	54.00	-22.75	AVG
7	3967.5000	37.10	5.09	42.19	74.00	-31.81	Peak
8	3967.5000	27.15	5.09	32.24	54.00	-21.76	AVG
9	4907.5000	35.30	6.89	42.19	74.00	-31.81	Peak
10	4907.5000	25.14	6.89	32.03	54.00	-21.97	AVG
11	5872.5000	35.48	10.32	45.80	74.00	-28.20	Peak
12	5872.5000	25.36	10.32	35.68	54.00	-18.32	AVG

EUT	IP Phone	Model Name	X5S
Temperature	25°C	Relative Humidity	60%
Test Voltage	DC 48V	Polarization	Horizontal
Test Mode	Handfree		
Note	PoE		
Test Engineer	Jason Yang		

80 dBuV/m

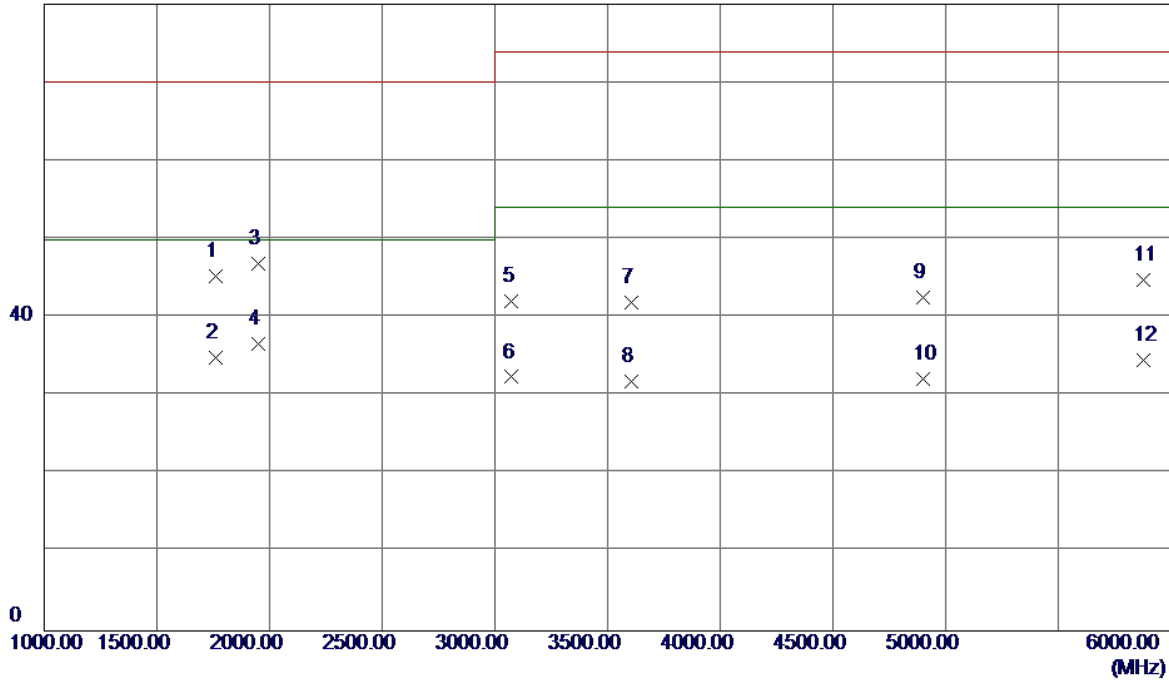

No.	Freq. MHz	Reading Level dBuV/m	Correct Factor dB	Measure ment dBuV/m	Limit dBuV/m	Margin dB	Detector
1	1762.5000	47.93	-2.63	45.30	70.00	-24.70	Peak
2	1762.5000	37.57	-2.63	34.94	50.00	-15.06	AVG
3	1952.5000	48.86	-1.93	46.93	70.00	-23.07	Peak
4 *	1952.5000	38.62	-1.93	36.69	50.00	-13.31	AVG
5	3075.0000	38.22	3.84	42.06	74.00	-31.94	Peak
6	3075.0000	28.56	3.84	32.40	54.00	-21.60	AVG
7	3607.5000	37.22	4.75	41.97	74.00	-32.03	Peak
8	3607.5000	27.15	4.75	31.90	54.00	-22.10	AVG
9	4902.5000	35.67	6.88	42.55	74.00	-31.45	Peak
10	4902.5000	25.33	6.88	32.21	54.00	-21.79	AVG
11	5877.5000	34.48	10.34	44.82	74.00	-29.18	Peak
12	5877.5000	24.25	10.34	34.59	54.00	-19.41	AVG

EUT	IP Phone	Model Name	X5S
Temperature	25°C	Relative Humidity	60%
Test Voltage	AC 230V/50Hz	Polarization	Vertical
Test Mode	Handset		
Note	Adapter		
Test Engineer	Jason Yang		

80 dBuV/m

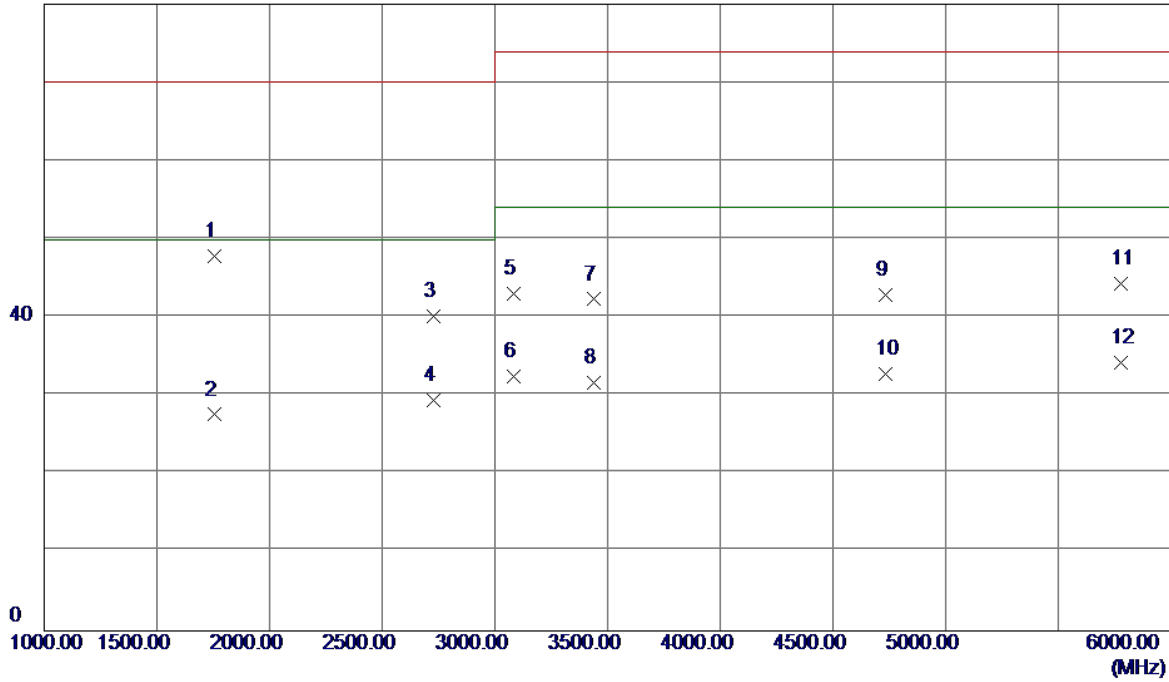

No.	Freq. MHz	Reading Level dBuV/m	Correct Factor dB	Measure ment dBuV/m	Limit dBuV/m	Margin dB	Detector
1	1755.0000	50.56	-2.65	47.91	70.00	-22.09	Peak
2	1755.0000	30.25	-2.65	27.60	50.00	-22.40	AVG
3	2727.5000	37.98	2.16	40.14	70.00	-29.86	Peak
4	2727.5000	27.22	2.16	29.38	50.00	-20.62	AVG
5	3085.0000	39.14	3.86	43.00	74.00	-31.00	Peak
6	3085.0000	28.65	3.86	32.51	54.00	-21.49	AVG
7	3440.0000	37.78	4.54	42.32	74.00	-31.68	Peak
8	3440.0000	27.15	4.54	31.69	54.00	-22.31	AVG
9	4735.0000	36.19	6.62	42.81	74.00	-31.19	Peak
10	4735.0000	26.25	6.62	32.87	54.00	-21.13	AVG
11	5777.5000	34.42	9.94	44.36	74.00	-29.64	Peak
12 *	5777.5000	24.25	9.94	34.19	54.00	-19.81	AVG

EUT	IP Phone	Model Name	X5S
Temperature	25°C	Relative Humidity	60%
Test Voltage	AC 230V/50Hz	Polarization	Horizontal
Test Mode	Handset		
Note	Adapter		
Test Engineer	Jason Yang		

80 dBuV/m

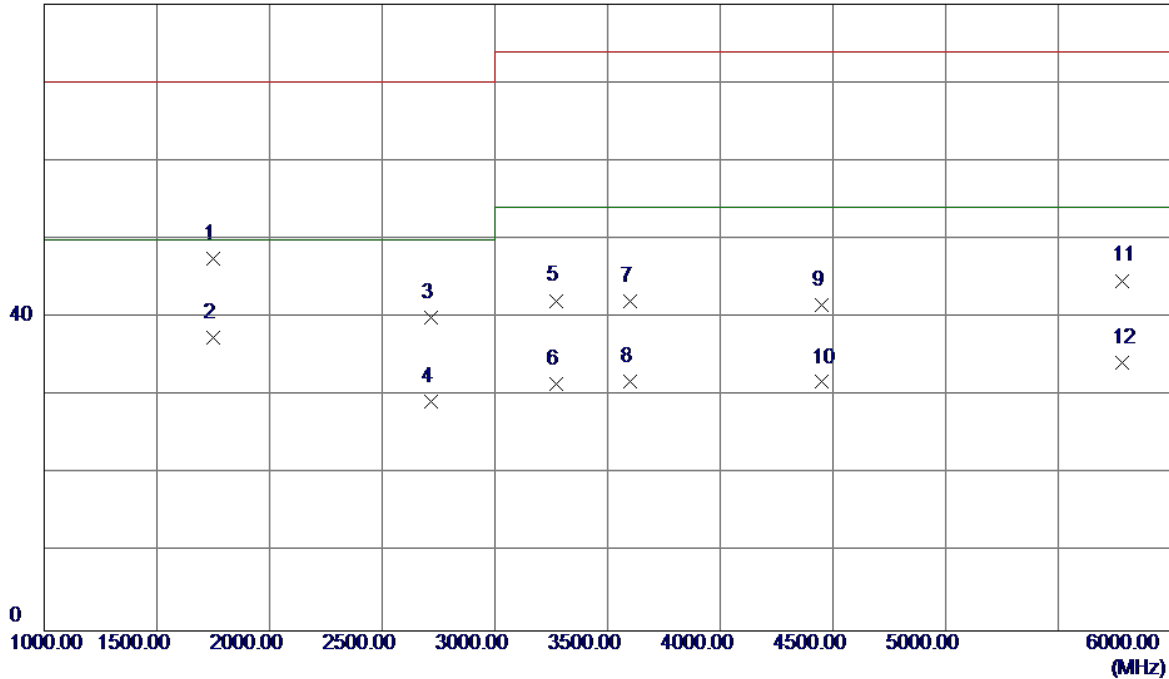

No.	Freq. MHz	Reading Level dBuV/m	Correct Factor dB	Measure ment dBuV/m	Limit dBuV/m	Margin dB	Detector
1	1750.0000	50.22	-2.67	47.55	70.00	-22.45	Peak
2 *	1750.0000	40.15	-2.67	37.48	50.00	-12.52	AVG
3	2717.5000	37.96	2.10	40.06	70.00	-29.94	Peak
4	2717.5000	27.25	2.10	29.35	50.00	-20.65	AVG
5	3270.0000	37.94	4.22	42.16	74.00	-31.84	Peak
6	3270.0000	27.24	4.22	31.46	54.00	-22.54	AVG
7	3600.0000	37.30	4.75	42.05	74.00	-31.95	Peak
8	3600.0000	27.12	4.75	31.87	54.00	-22.13	AVG
9	4452.5000	35.53	6.14	41.67	74.00	-32.33	Peak
10	4452.5000	25.62	6.14	31.76	54.00	-22.24	AVG
11	5785.0000	34.75	9.97	44.72	74.00	-29.28	Peak
12	5785.0000	24.24	9.97	34.21	54.00	-19.79	AVG

EUT	IP Phone	Model Name	X5S
Temperature	25°C	Relative Humidity	60%
Test Voltage	DC 48V	Polarization	Vertical
Test Mode	Handset		
Note	PoE		
Test Engineer	Jason Yang		

80 dBuV/m

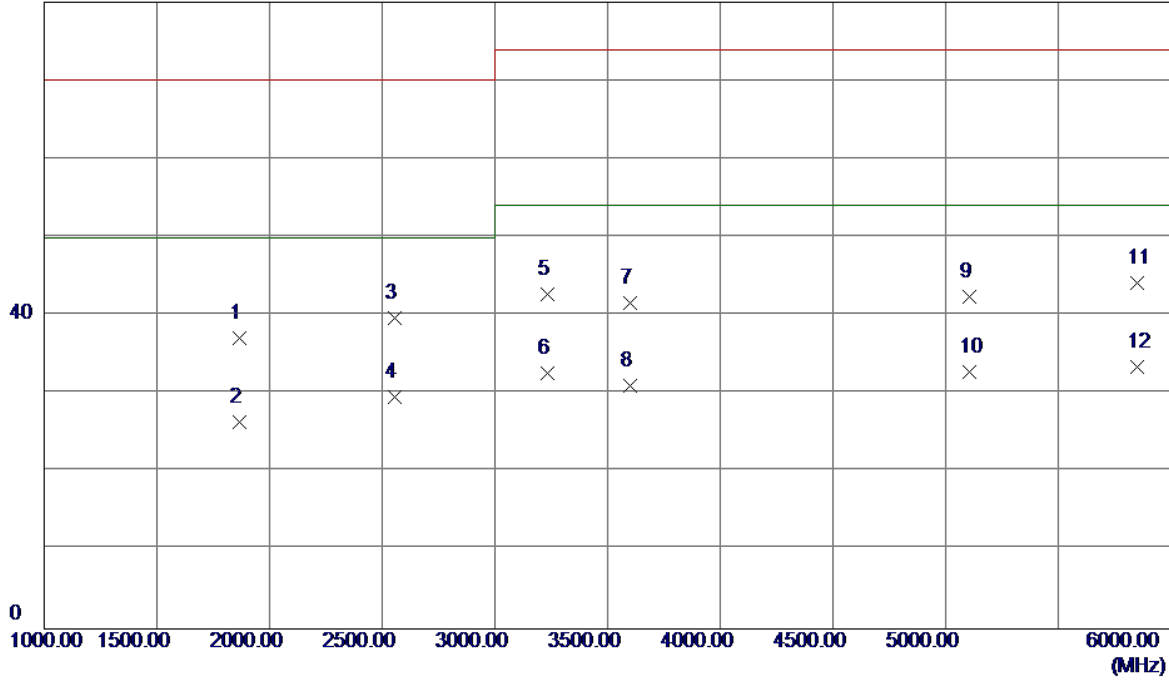

No.	Freq. MHz	Reading Level dBuV/m	Correct Factor dB	Measurement dBuV/m	Limit dBuV/m	Margin dB	Detector
1	1865.0000	39.33	-2.25	37.08	70.00	-32.92	Peak
2	1865.0000	28.62	-2.25	26.37	50.00	-23.63	AVG
3	2557.5000	38.51	1.20	39.71	70.00	-30.29	Peak
4 *	2557.5000	28.45	1.20	29.65	50.00	-20.35	AVG
5	3235.0000	38.63	4.15	42.78	74.00	-31.22	Peak
6	3235.0000	28.46	4.15	32.61	54.00	-21.39	AVG
7	3600.0000	36.84	4.75	41.59	74.00	-32.41	Peak
8	3600.0000	26.35	4.75	31.10	54.00	-22.90	AVG
9	5105.0000	35.00	7.41	42.41	74.00	-31.59	Peak
10	5105.0000	25.36	7.41	32.77	54.00	-21.23	AVG
11	5852.5000	33.88	10.24	44.12	74.00	-29.88	Peak
12	5852.5000	23.21	10.24	33.45	54.00	-20.55	AVG

EUT	IP Phone	Model Name	X5S
Temperature	25°C	Relative Humidity	60%
Test Voltage	DC 48V	Polarization	Horizontal
Test Mode	Handset		
Note	PoE		
Test Engineer	Jason Yang		

80 dBuV/m

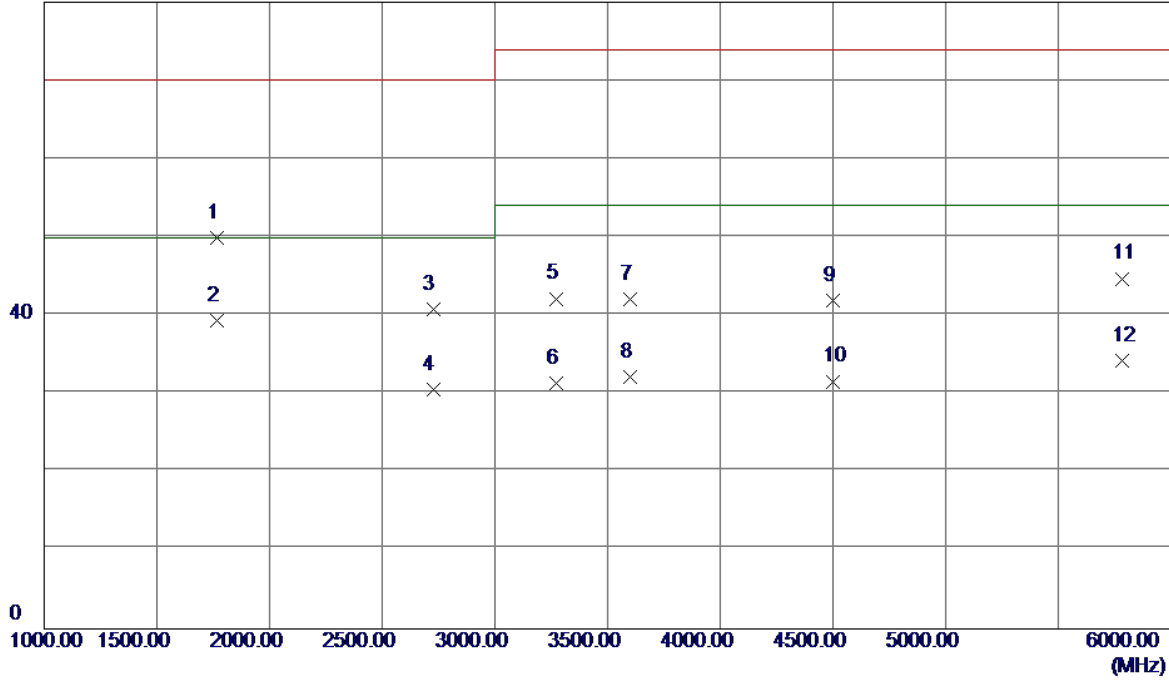

No.	Freq. MHz	Reading Level dBuV/m	Correct Factor dB	Measure ment dBuV/m	Limit dBuV/m	Margin dB	Detector
1	1765.0000	52.53	-2.62	49.91	70.00	-20.09	Peak
2 *	1765.0000	42.00	-2.62	39.38	50.00	-10.62	AVG
3	2725.0000	38.69	2.15	40.84	70.00	-29.16	Peak
4	2725.0000	28.36	2.15	30.51	50.00	-19.49	AVG
5	3270.0000	37.94	4.22	42.16	74.00	-31.84	Peak
6	3270.0000	27.14	4.22	31.36	54.00	-22.64	AVG
7	3600.0000	37.30	4.75	42.05	74.00	-31.95	Peak
8	3600.0000	27.45	4.75	32.20	54.00	-21.80	AVG
9	4502.5000	35.72	6.25	41.97	74.00	-32.03	Peak
10	4502.5000	25.35	6.25	31.60	54.00	-22.40	AVG
11	5785.0000	34.75	9.97	44.72	74.00	-29.28	Peak
12	5785.0000	24.24	9.97	34.21	54.00	-19.79	AVG

EUT	IP Phone	Model Name	X5S
Temperature	25°C	Relative Humidity	60%
Test Voltage	AC 230V/50Hz	Polarization	Vertical
Test Mode	Headphone		
Note	Adapter		
Test Engineer	Jason Yang		

80 dBuV/m

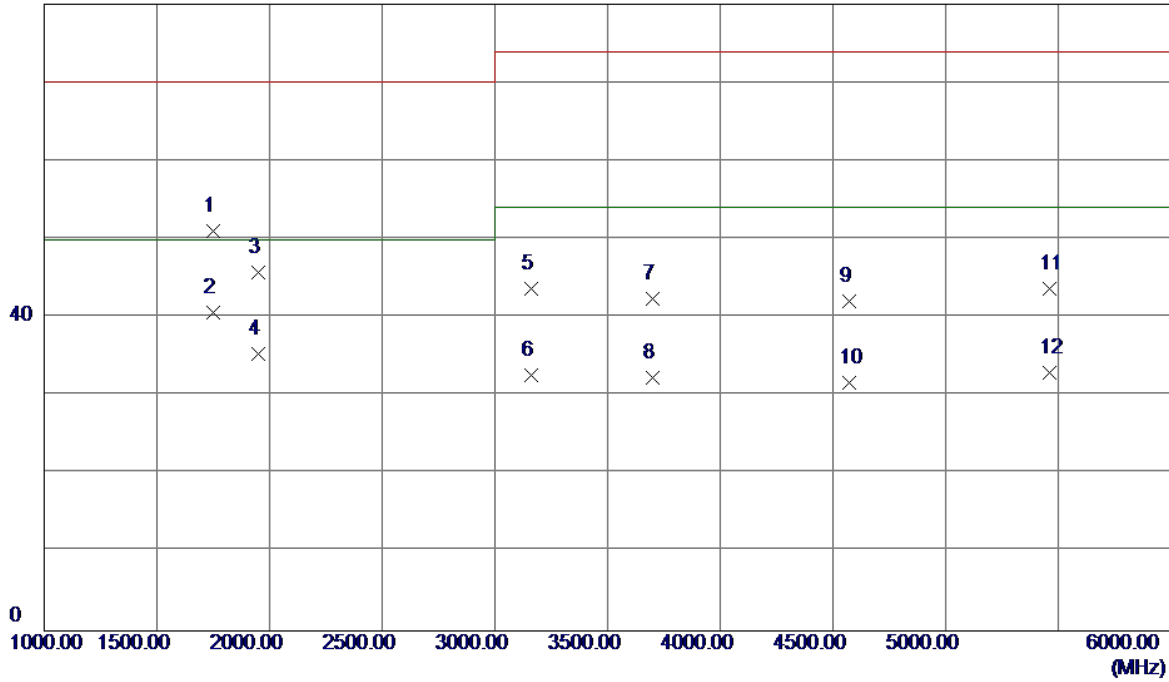

No.	Freq. MHz	Reading Level dBuV/m	Correct Factor dB	Measure ment dBuV/m	Limit dBuV/m	Margin dB	Detector
1	1750.0000	53.76	-2.67	51.09	70.00	-18.91	Peak
2 *	1750.0000	43.26	-2.67	40.59	50.00	-9.41	AVG
3	1952.5000	47.68	-1.93	45.75	70.00	-24.25	Peak
4	1952.5000	37.24	-1.93	35.31	50.00	-14.69	AVG
5	3160.0000	39.66	4.01	43.67	74.00	-30.33	Peak
6	3160.0000	28.62	4.01	32.63	54.00	-21.37	AVG
7	3702.5000	37.54	4.84	42.38	74.00	-31.62	Peak
8	3702.5000	27.45	4.84	32.29	54.00	-21.71	AVG
9	4572.5000	35.75	6.36	42.11	74.00	-31.89	Peak
10	4572.5000	25.36	6.36	31.72	54.00	-22.28	AVG
11	5460.0000	34.95	8.67	43.62	74.00	-30.38	Peak
12	5460.0000	24.25	8.67	32.92	54.00	-21.08	AVG

EUT	IP Phone	Model Name	X5S
Temperature	25°C	Relative Humidity	60%
Test Voltage	AC 230V/50Hz	Polarization	Horizontal
Test Mode	Headphone		
Note	Adapter		
Test Engineer	Jason Yang		

80 dBuV/m

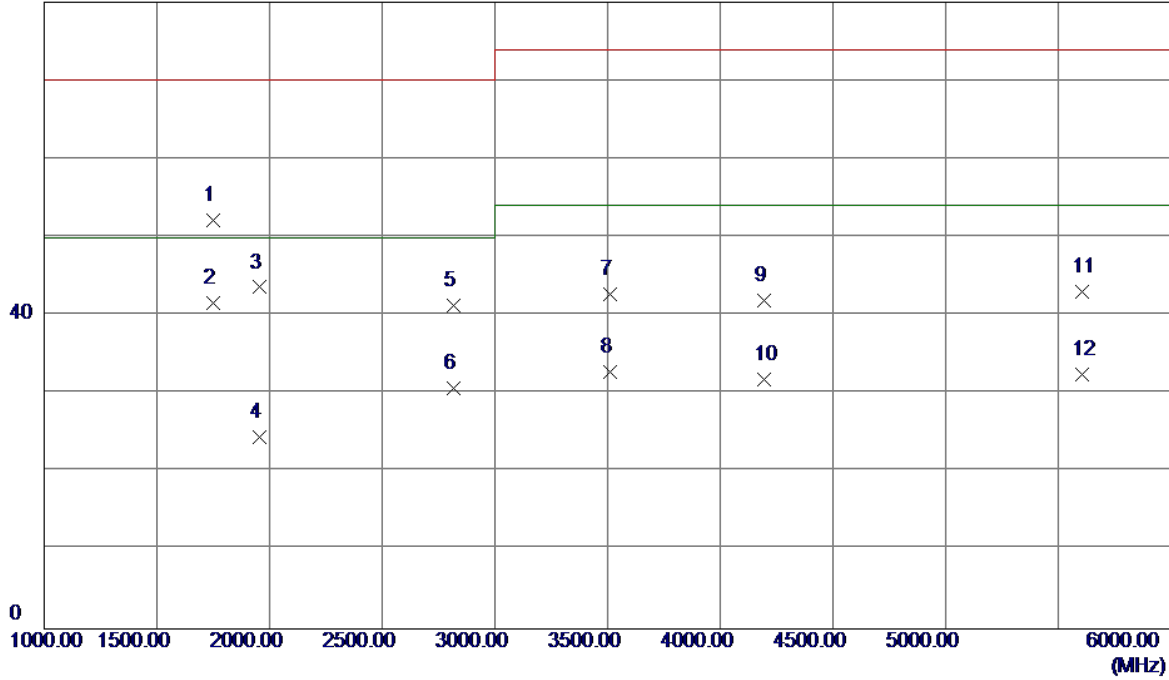

No.	Freq. MHz	Reading Level dBuV/m	Correct Factor dB	Measure ment dBuV/m	Limit dBuV/m	Margin dB	Detector
1	1747.5000	54.78	-2.68	52.10	70.00	-17.90	Peak
2 *	1747.5000	44.27	-2.68	41.59	50.00	-8.41	AVG
3	1955.0000	45.52	-1.92	43.60	70.00	-26.40	Peak
4	1955.0000	26.35	-1.92	24.43	50.00	-25.57	AVG
5	2815.0000	38.69	2.65	41.34	70.00	-28.66	Peak
6	2815.0000	28.14	2.65	30.79	50.00	-19.21	AVG
7	3510.0000	38.09	4.66	42.75	74.00	-31.25	Peak
8	3510.0000	28.11	4.66	32.77	54.00	-21.23	AVG
9	4195.0000	36.34	5.56	41.90	74.00	-32.10	Peak
10	4195.0000	26.35	5.56	31.91	54.00	-22.09	AVG
11	5607.5000	33.85	9.25	43.10	74.00	-30.90	Peak
12	5607.5000	23.19	9.25	32.44	54.00	-21.56	AVG

EUT	IP Phone	Model Name	X5S
Temperature	25°C	Relative Humidity	60%
Test Voltage	DC 48V	Polarization	Vertical
Test Mode	Headphone		
Note	PoE		
Test Engineer	Jason Yang		

80 dBuV/m

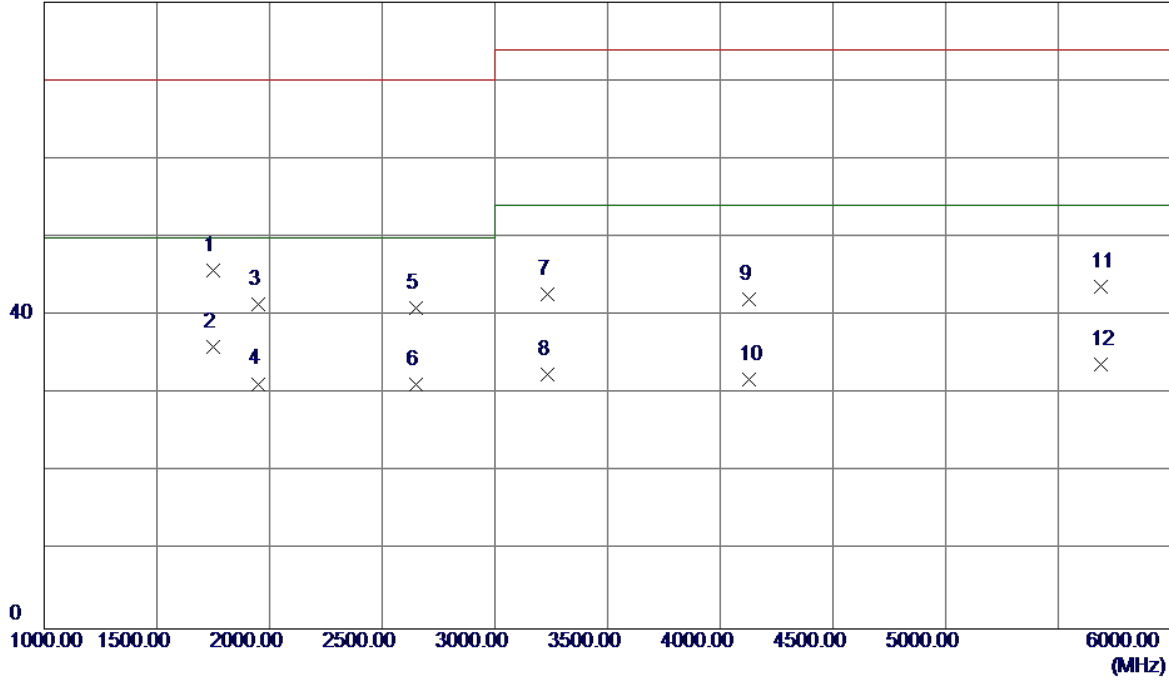

No.	Freq. MHz	Reading Level dBuV/m	Correct Factor dB	Measure ment dBuV/m	Limit dBuV/m	Margin dB	Detector
1	1747.5000	48.37	-2.68	45.69	70.00	-24.31	Peak
2 *	1747.5000	38.67	-2.68	35.99	50.00	-14.01	AVG
3	1950.0000	43.41	-1.94	41.47	70.00	-28.53	Peak
4	1950.0000	33.22	-1.94	31.28	50.00	-18.72	AVG
5	2652.5000	39.25	1.74	40.99	70.00	-29.01	Peak
6	2652.5000	29.46	1.74	31.20	50.00	-18.80	AVG
7	3235.0000	38.63	4.15	42.78	74.00	-31.22	Peak
8	3235.0000	28.36	4.15	32.51	54.00	-21.49	AVG
9	4130.0000	36.70	5.41	42.11	74.00	-31.89	Peak
10	4130.0000	26.36	5.41	31.77	54.00	-22.23	AVG
11	5687.5000	34.13	9.57	43.70	74.00	-30.30	Peak
12	5687.5000	24.25	9.57	33.82	54.00	-20.18	AVG

EUT	IP Phone	Model Name	X5S
Temperature	25°C	Relative Humidity	60%
Test Voltage	DC 48V	Polarization	Horizontal
Test Mode	Headphone		
Note	PoE		
Test Engineer	Jason Yang		

80 dBuV/m

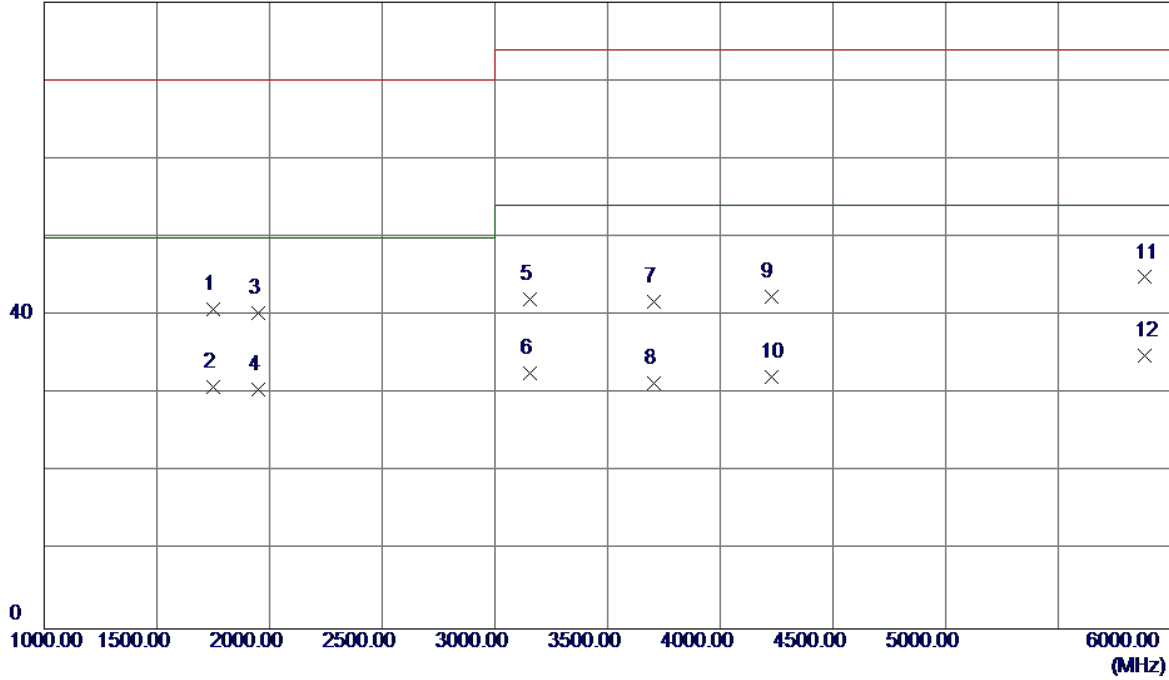

No.	Freq. MHz	Reading Level dBuV/m	Correct Factor dB	Measure ment dBuV/m	Limit dBuV/m	Margin dB	Detector
1	1750.0000	43.48	-2.67	40.81	70.00	-29.19	Peak
2	1750.0000	33.56	-2.67	30.89	50.00	-19.11	AVG
3	1952.5000	42.31	-1.93	40.38	70.00	-29.62	Peak
4	1952.5000	32.55	-1.93	30.62	50.00	-19.38	AVG
5	3157.5000	38.10	4.00	42.10	74.00	-31.90	Peak
6	3157.5000	28.63	4.00	32.63	54.00	-21.37	AVG
7	3705.0000	36.87	4.85	41.72	74.00	-32.28	Peak
8	3705.0000	26.45	4.85	31.30	54.00	-22.70	AVG
9	4225.0000	36.77	5.63	42.40	74.00	-31.60	Peak
10	4225.0000	26.60	5.63	32.23	54.00	-21.77	AVG
11	5882.5000	34.52	10.36	44.88	74.00	-29.12	Peak
12 *	5882.5000	24.57	10.36	34.93	54.00	-19.07	AVG

EUT	IP Phone	Model Name	X5S
Temperature	25°C	Relative Humidity	60%
Test Voltage	AC 110V/60Hz	Polarization	Vertical
Test Mode	Headphone		
Note	Adapter		
Test Engineer	Jason Yang		

80 dBuV/m

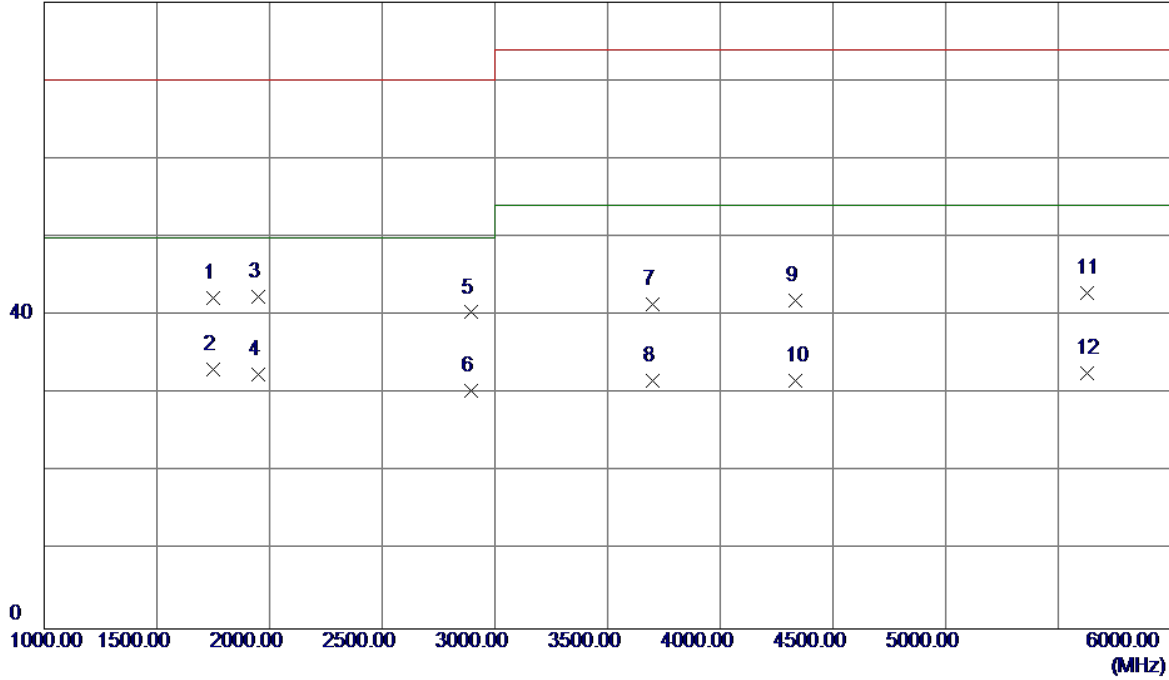

No.	Freq. MHz	Reading Level dBuV/m	Correct Factor dB	Measure ment dBuV/m	Limit dBuV/m	Margin dB	Detector
1	1747.5000	44.91	-2.68	42.23	70.00	-27.77	Peak
2 *	1747.5000	35.73	-2.68	33.05	50.00	-16.95	AVG
3	1952.5000	44.32	-1.93	42.39	70.00	-27.61	Peak
4	1952.5000	34.47	-1.93	32.54	50.00	-17.46	AVG
5	2892.5000	37.31	3.09	40.40	70.00	-29.60	Peak
6	2892.5000	27.33	3.09	30.42	50.00	-19.58	AVG
7	3702.5000	36.66	4.84	41.50	74.00	-32.50	Peak
8	3702.5000	26.88	4.84	31.72	54.00	-22.28	AVG
9	4332.5000	36.04	5.87	41.91	74.00	-32.09	Peak
10	4332.5000	25.81	5.87	31.68	54.00	-22.32	AVG
11	5625.0000	33.53	9.32	42.85	74.00	-31.15	Peak
12	5625.0000	23.25	9.32	32.57	54.00	-21.43	AVG

EUT	IP Phone	Model Name	X5S
Temperature	25°C	Relative Humidity	60%
Test Voltage	AC 110V/60Hz	Polarization	Horizontal
Test Mode	Headphone		
Note	Adapter		
Test Engineer	Jason Yang		

80 dBuV/m

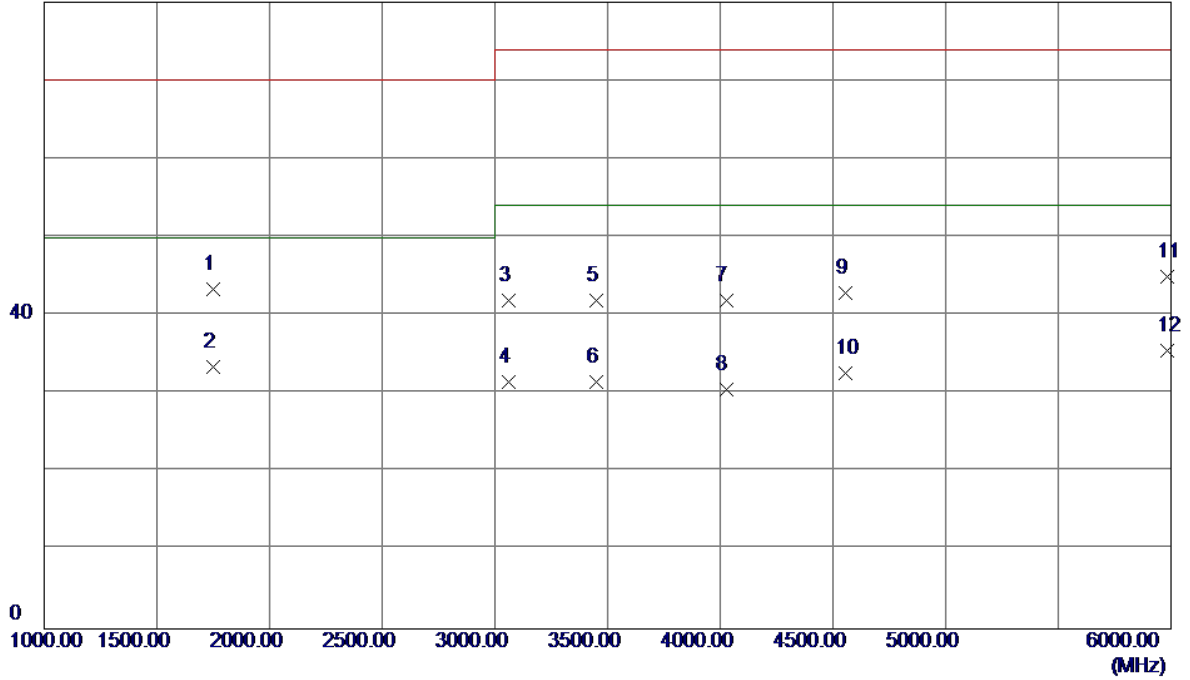

No.	Freq. MHz	Reading Level dBuV/m	Correct Factor dB	Measure ment dBuV/m	Limit dBuV/m	Margin dB	Detector
1	1747.5000	46.04	-2.68	43.36	70.00	-26.64	Peak
2 *	1747.5000	36.13	-2.68	33.45	50.00	-16.55	AVG
3	3062.5000	38.13	3.82	41.95	74.00	-32.05	Peak
4	3062.5000	27.77	3.82	31.59	54.00	-22.41	AVG
5	3447.5000	37.42	4.55	41.97	74.00	-32.03	Peak
6	3447.5000	27.02	4.55	31.57	54.00	-22.43	AVG
7	4025.0000	36.69	5.18	41.87	74.00	-32.13	Peak
8	4025.0000	25.36	5.18	30.54	54.00	-23.46	AVG
9	4555.0000	36.60	6.33	42.93	74.00	-31.07	Peak
10	4555.0000	26.32	6.33	32.65	54.00	-21.35	AVG
11	5985.0000	34.24	10.78	45.02	74.00	-28.98	Peak
12	5985.0000	24.70	10.78	35.48	54.00	-18.52	AVG

4.2 CONDUCTED EMISSION MEASUREMENT AT AC MAINS POWER PORTS

4.2.1 LIMITS

Requirements for conducted emissions from AC mains power ports of Class A equipment

Table clause	Frequency Range MHz	Coupling Device	Detector Type / bandwidth	Class A Limits (dB(μV))
A9.1	0.15 - 0.5	AMN	Quasi Peak / 9 kHz	79
	0.5 - 30			73
A9.2	0.15 - 0.5	AMN	Average / 9 kHz	66
	0.5 - 30			60

Apply A9.1 and A9.2 across the entire frequency range.

Requirements for conducted emissions from AC mains power ports of Class B equipment

Table clause	Frequency Range MHz	Coupling Device	Detector Type / bandwidth	Class B Limits (dB(μV))
A10.1	0.15 - 0.5	AMN	Quasi Peak / 9 kHz	66-56
	0.5 - 5			56
	5 - 30			60
A10.2	0.15 - 0.5	AMN	Average / 9 kHz	56-46
	0.5 - 5			46
	5 - 30			50

Apply A10.1 and A10.2 across the entire frequency range.

NOTE:

- (1) The test result calculated as following:
 Measurement Value = Reading Level + Correct Factor
 Correct Factor = Insertion Loss + Cable Loss + Attenuator Factor(if use)
 Margin Level = Measurement Value – Limit Value

4.2.2 MEASUREMENT INSTRUMENTS LIST

Item	Kind of Equipment	Manufacturer	Type No.	Serial No.	Calibrated until
1	50Ω Terminator	SHX	TF2-3G-A	8122901	Mar. 26, 2018
2	TWO-LINE V-NETWORK	R&S	ENV216	100526	Mar. 26, 2018
3	EMI Test Receiver	R&S	ESR3	101862	Sep. 04, 2017
4	Artificial-Mains Network	SCHWARZBECK	NSLK 8127	8127685	Sep. 04, 2017
5	Cable	N/A	RG400 12m	N/A	Mar. 07, 2018
6	Measurement Software	Farad	EZ-EMC Ver.NB-03A 1-01	N/A	N/A

Remark: "N/A" denotes no model name, no serial no. or no calibration specified.
 All calibration period of equipment list is one year.

4.2.3 TEST PROCEDURE

- a. The EUT was placed 0.8 meters from the horizontal ground plane with EUT being connected to the power mains through a line impedance stabilization network (LISN). All other support equipments powered from additional LISN(s). The LISN provide 50 Ohm/ 50uH of coupling impedance for the measuring instrument.
- b. Interconnecting cables that hang closer than 40 cm to the ground plane shall be folded back and forth in the center forming a bundle 30 to 40 cm long.
- c. I/O cables that are not connected to a peripheral shall be bundled in the center. The end of the cable may be terminated, if required, using the correct terminating impedance. The overall length shall not exceed 1 m.
- d. LISN at least 80 cm from nearest part of EUT chassis.
- e. For the actual test configuration, please refer to the related Item –EUT Test Photos.

4.2.4 DEVIATION FROM TEST STANDARD

No deviation

4.2.5 TEST SETUP

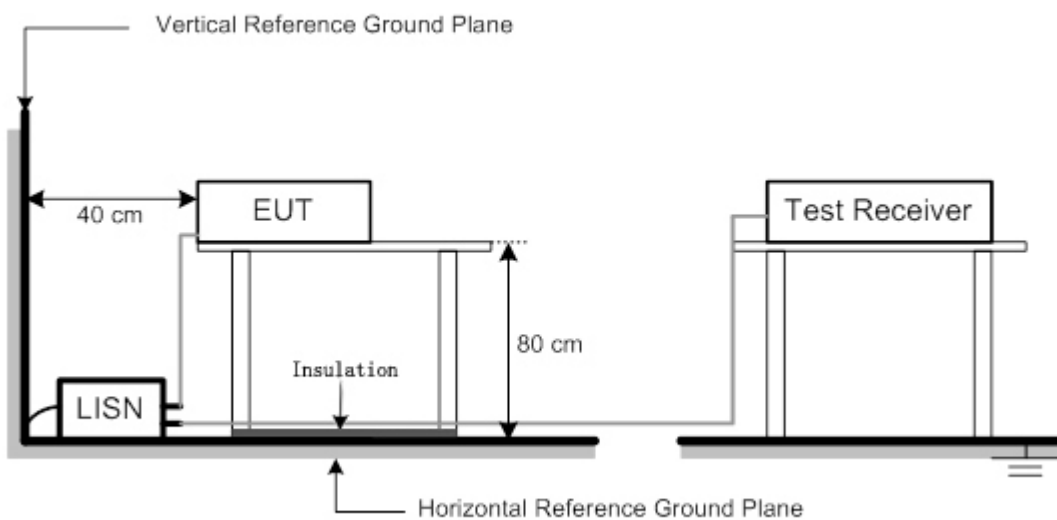

4.2.6 TEST RESULTS

EUT	IP Phone	Model Name	X5S
Temperature	25°C	Relative Humidity	53%
Test Voltage	AC 230V/50Hz	Phase	Line
Test Mode	Handfree		
Note	Adapter		
Test Engineer	Jason Yang		

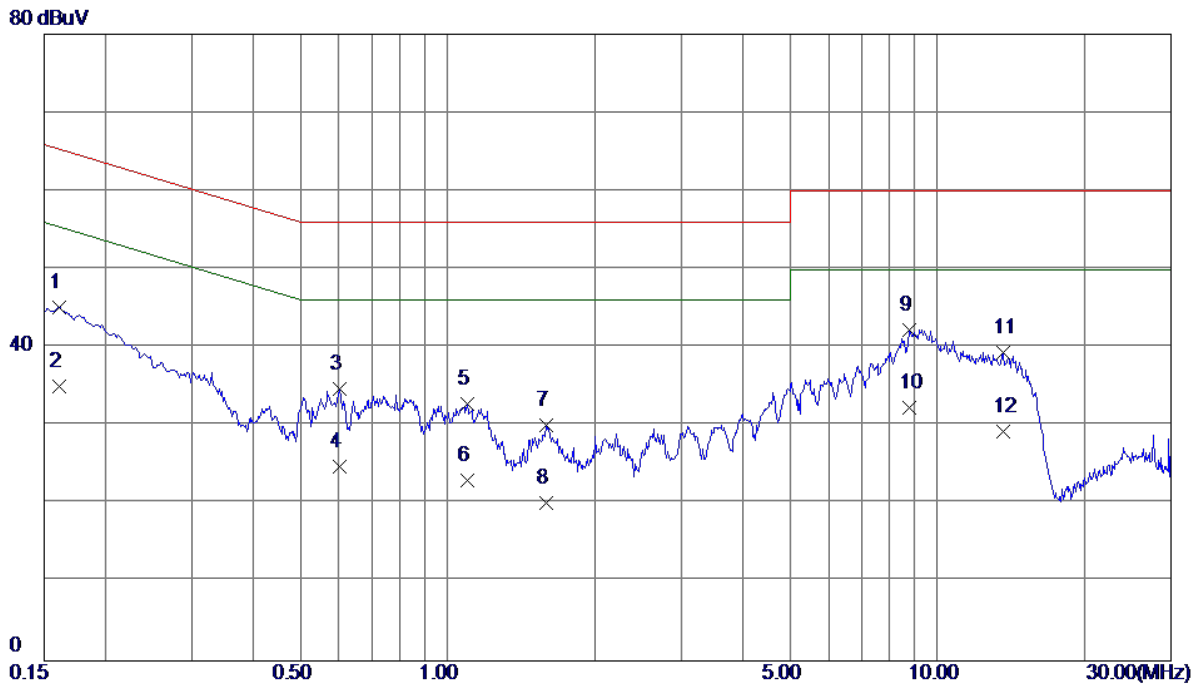

No.	Freq. MHz	Reading Level dBuV	Correct Factor dB	Measure ment dBuV	Limit dBuV	Margin dB	Detector
1	0.1613	35.42	9.68	45.10	65.40	-20.30	QP
2	0.1613	25.30	9.68	34.98	55.40	-20.42	AVG
3	0.6022	25.01	9.74	34.75	56.00	-21.25	QP
4	0.6022	15.10	9.74	24.84	46.00	-21.16	AVG
5	1.0950	23.05	9.79	32.84	56.00	-23.16	QP
6	1.0950	13.20	9.79	22.99	46.00	-23.01	AVG
7	1.5923	20.23	9.82	30.05	56.00	-25.95	QP
8	1.5923	10.29	9.82	20.11	46.00	-25.89	AVG
9	8.7630	31.96	10.25	42.21	60.00	-17.79	QP
10 *	8.7630	22.11	10.25	32.36	50.00	-17.64	AVG
11	13.6163	28.98	10.42	39.40	60.00	-20.60	QP
12	13.6163	18.90	10.42	29.32	50.00	-20.68	AVG

EUT	IP Phone	Model Name	X5S
Temperature	25°C	Relative Humidity	53%
Test Voltage	AC 230V/50Hz	Phase	Neutral
Test Mode	Handfree		
Note	Adapter		
Test Engineer	Jason Yang		

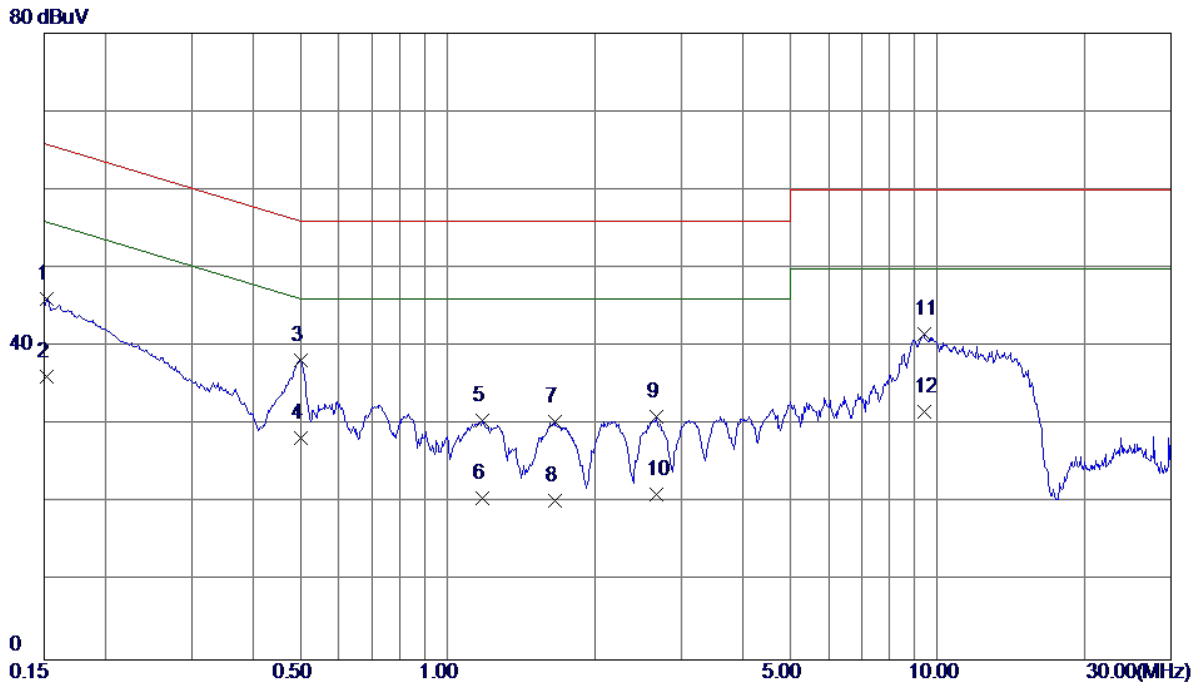

No.	Freq. MHz	Reading Level dBuV	Correct Factor dB	Measure ment dBuV	Limit dBuV	Margin dB	Detector
1	0.1522	36.47	9.66	46.13	65.88	-19.75	QP
2	0.1522	26.50	9.66	36.16	55.88	-19.72	AVG
3	0.5010	28.56	9.72	38.28	56.00	-17.72	QP
4 *	0.5010	18.60	9.72	28.32	46.00	-17.68	AVG
5	1.1782	20.71	9.79	30.50	56.00	-25.50	QP
6	1.1782	10.80	9.79	20.59	46.00	-25.41	AVG
7	1.6530	20.60	9.82	30.42	56.00	-25.58	QP
8	1.6530	10.50	9.82	20.32	46.00	-25.68	AVG
9	2.6655	21.23	9.88	31.11	56.00	-24.89	QP
10	2.6655	11.30	9.88	21.18	46.00	-24.82	AVG
11	9.3817	31.29	10.31	41.60	60.00	-18.40	QP
12	9.3817	21.40	10.31	31.71	50.00	-18.29	AVG

EUT	IP Phone	Model Name	X5S
Temperature	25°C	Relative Humidity	53%
Test Voltage	AC 230V/50Hz	Phase	Line
Test Mode	Handset		
Note	Adapter		
Test Engineer	Jason Yang		

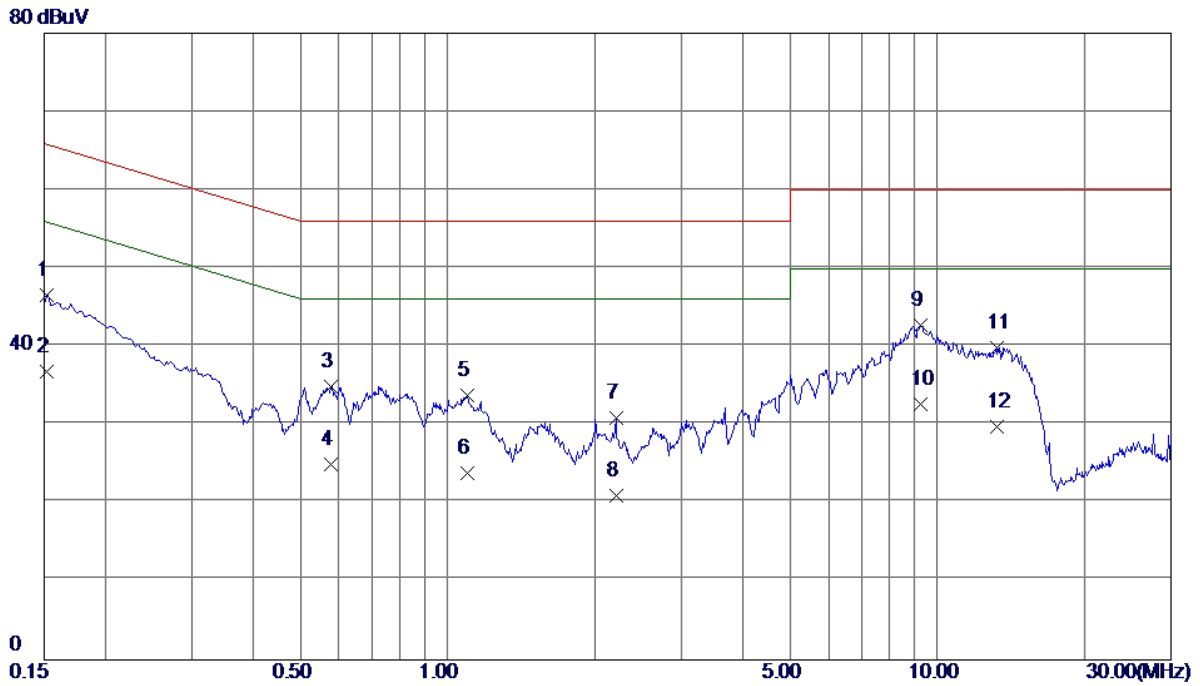

No.	Freq. MHz	Reading Level dBuV	Correct Factor dB	Measure ment dBuV	Limit dBuV	Margin dB	Detector
1	0.1522	36.92	9.67	46.59	65.88	-19.29	QP
2	0.1522	27.10	9.67	36.77	55.88	-19.11	AVG
3	0.5775	25.14	9.74	34.88	56.00	-21.12	QP
4	0.5775	15.20	9.74	24.94	46.00	-21.06	AVG
5	1.0950	24.00	9.79	33.79	56.00	-22.21	QP
6	1.0950	14.10	9.79	23.89	46.00	-22.11	AVG
7	2.2065	20.95	9.87	30.82	56.00	-25.18	QP
8	2.2065	11.10	9.87	20.97	46.00	-25.03	AVG
9 *	9.2423	32.40	10.28	42.68	60.00	-17.32	QP
10	9.2423	22.39	10.28	32.67	50.00	-17.33	AVG
11	13.2270	29.48	10.41	39.89	60.00	-20.11	QP
12	13.2270	19.30	10.41	29.71	50.00	-20.29	AVG

EUT	IP Phone	Model Name	X5S
Temperature	25°C	Relative Humidity	53%
Test Voltage	AC 230V/50Hz	Phase	Neutral
Test Mode	Handset		
Note	Adapter		
Test Engineer	Jason Yang		

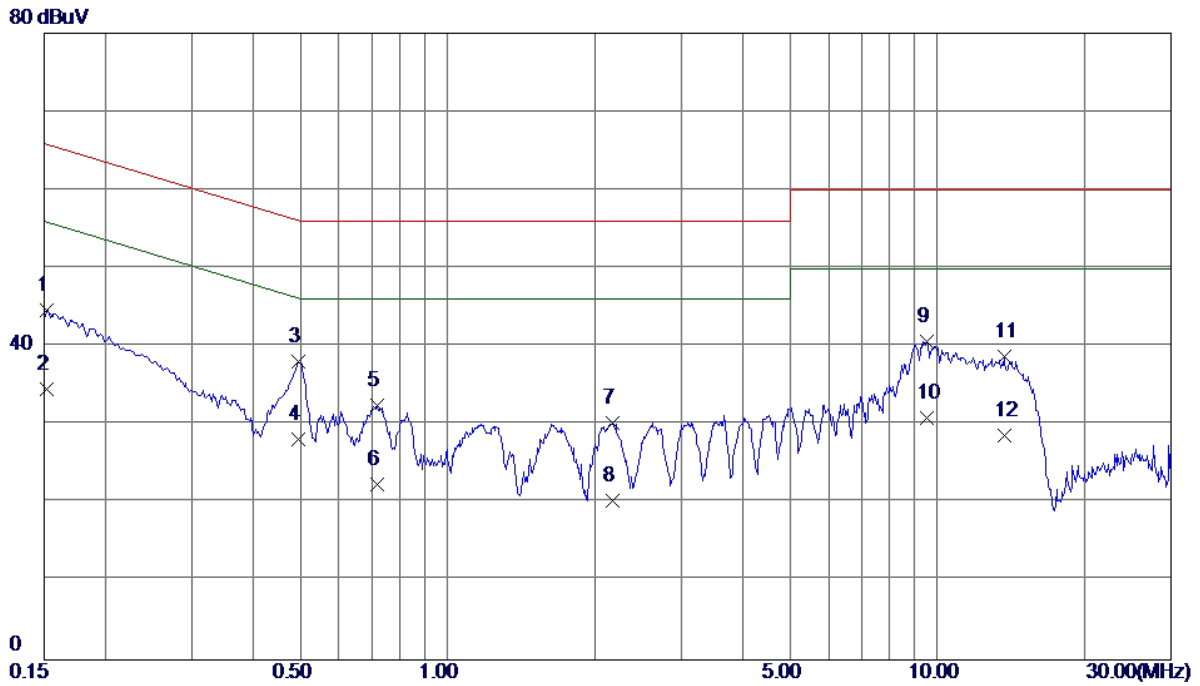

No.	Freq. MHz	Reading Level dBuV	Correct Factor dB	Measure ment dBuV	Limit dBuV	Margin dB	Detector
1	0.1522	34.96	9.66	44.62	65.88	-21.26	QP
2	0.1522	24.90	9.66	34.56	55.88	-21.32	AVG
3	0.4965	28.40	9.72	38.12	56.06	-17.94	QP
4 *	0.4965	18.50	9.72	28.22	46.06	-17.84	AVG
5	0.7170	22.71	9.74	32.45	56.00	-23.55	QP
6	0.7170	12.70	9.74	22.44	46.00	-23.56	AVG
7	2.1773	20.33	9.86	30.19	56.00	-25.81	QP
8	2.1773	10.40	9.86	20.26	46.00	-25.74	AVG
9	9.5235	30.39	10.32	40.71	60.00	-19.29	QP
10	9.5235	20.50	10.32	30.82	50.00	-19.18	AVG
11	13.6860	28.18	10.50	38.68	60.00	-21.32	QP
12	13.6860	18.20	10.50	28.70	50.00	-21.30	AVG

EUT	IP Phone	Model Name	X5S
Temperature	25°C	Relative Humidity	53%
Test Voltage	AC 230V/50Hz	Phase	Line
Test Mode	Headphone		
Note	Adapter		
Test Engineer	Jason Yang		

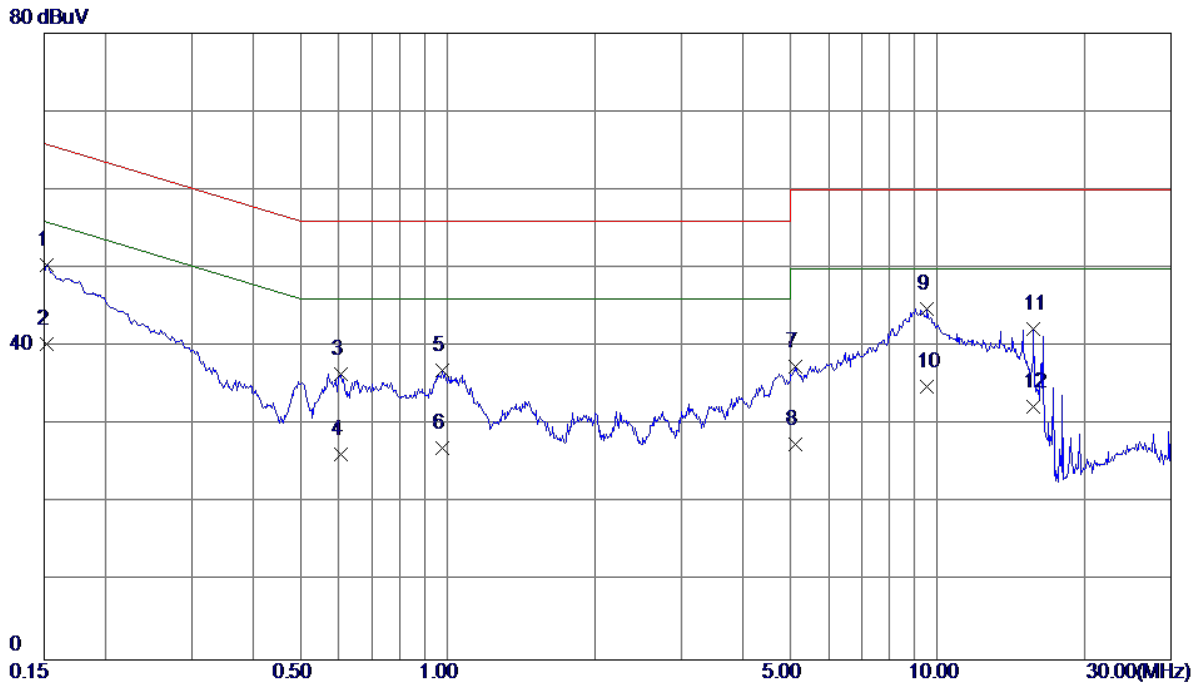

No.	Freq. MHz	Reading Level dBuV	Correct Factor dB	Measure ment dBuV	Limit dBuV	Margin dB	Detector
1	0.1522	40.80	9.67	50.47	65.88	-15.41	QP
2	0.1522	30.70	9.67	40.37	55.88	-15.51	AVG
3	0.6045	26.78	9.74	36.52	56.00	-19.48	QP
4	0.6045	16.50	9.74	26.24	46.00	-19.76	AVG
5	0.9780	27.21	9.77	36.98	56.00	-19.02	QP
6	0.9780	17.31	9.77	27.08	46.00	-18.92	AVG
7	5.1405	27.40	10.05	37.45	60.00	-22.55	QP
8	5.1405	17.50	10.05	27.55	50.00	-22.45	AVG
9	9.5460	34.58	10.29	44.87	60.00	-15.13	QP
10 *	9.5460	24.60	10.29	34.89	50.00	-15.11	AVG
11	15.7268	31.71	10.49	42.20	60.00	-17.80	QP
12	15.7268	21.79	10.49	32.28	50.00	-17.72	AVG

EUT	IP Phone	Model Name	X5S
Temperature	25°C	Relative Humidity	53%
Test Voltage	AC 230V/50Hz	Phase	Neutral
Test Mode	Headphone		
Note	Adapter		
Test Engineer	Jason Yang		

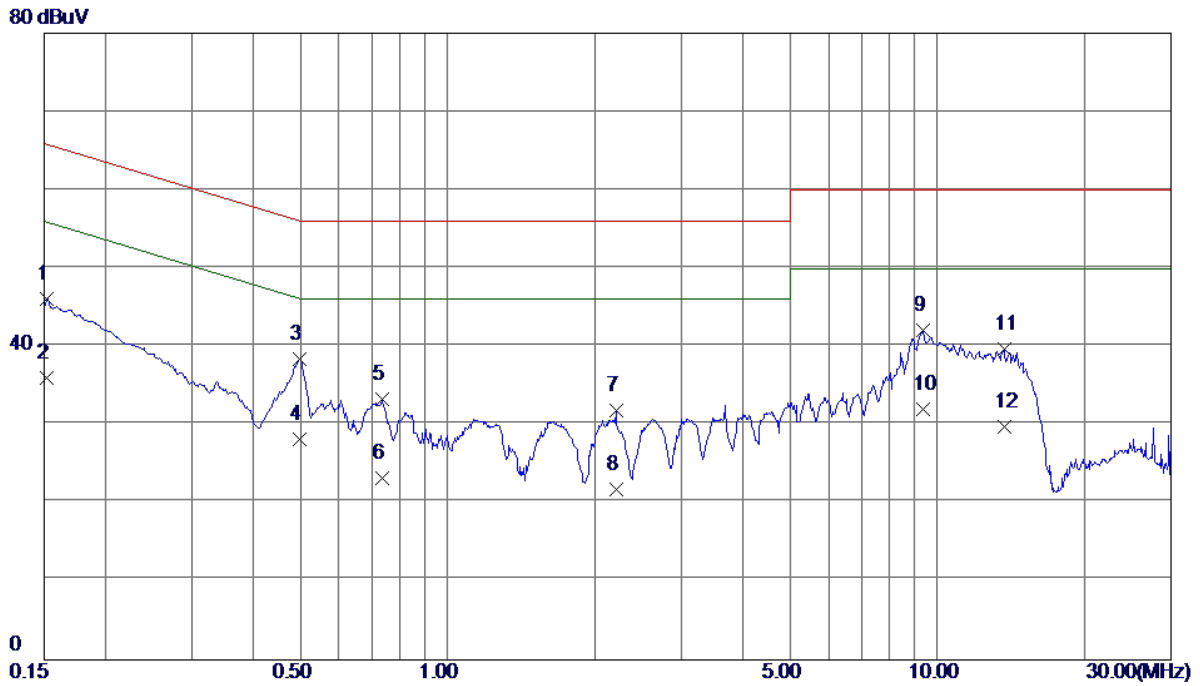

No.	Freq. MHz	Reading Level dBuV	Correct Factor dB	Measure ment dBuV	Limit dBuV	Margin dB	Detector
1	0.1522	36.49	9.66	46.15	65.88	-19.73	QP
2	0.1522	26.30	9.66	35.96	55.88	-19.92	AVG
3 *	0.4987	28.61	9.72	38.33	56.02	-17.69	QP
4	0.4987	18.50	9.72	28.22	46.02	-17.80	AVG
5	0.7350	23.47	9.74	33.21	56.00	-22.79	QP
6	0.7350	13.50	9.74	23.24	46.00	-22.76	AVG
7	2.2088	21.92	9.86	31.78	56.00	-24.22	QP
8	2.2088	11.90	9.86	21.76	46.00	-24.24	AVG
9	9.3480	31.70	10.31	42.01	60.00	-17.99	QP
10	9.3480	21.70	10.31	32.01	50.00	-17.99	AVG
11	13.6725	29.18	10.50	39.68	60.00	-20.32	QP
12	13.6725	19.20	10.50	29.70	50.00	-20.30	AVG

EUT	IP Phone	Model Name	X5S
Temperature	25°C	Relative Humidity	53%
Test Voltage	AC 110V/60Hz	Phase	Line
Test Mode	Headphone		
Note	Adapter		
Test Engineer	Jason Yang		

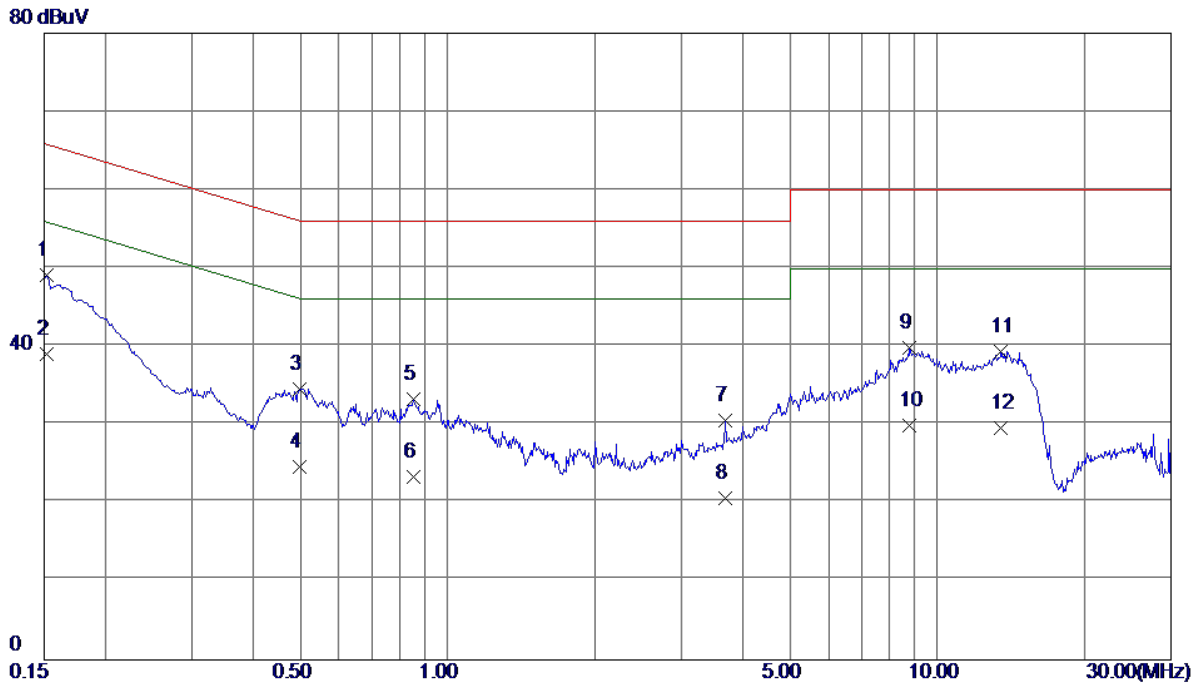

No.	Freq. MHz	Reading Level dBuV	Correct Factor dB	Measure ment dBuV	Limit dBuV	Margin dB	Detector
1 *	0.1522	39.44	9.67	49.11	65.88	-16.77	QP
2	0.1522	29.30	9.67	38.97	55.88	-16.91	AVG
3	0.4987	24.88	9.74	34.62	56.02	-21.40	QP
4	0.4987	14.90	9.74	24.64	46.02	-21.38	AVG
5	0.8520	23.58	9.75	33.33	56.00	-22.67	QP
6	0.8520	13.60	9.75	23.35	46.00	-22.65	AVG
7	3.6825	20.64	9.95	30.59	56.00	-25.41	QP
8	3.6825	10.70	9.95	20.65	46.00	-25.35	AVG
9	8.7900	29.58	10.26	39.84	60.00	-20.16	QP
10	8.7900	19.60	10.26	29.86	50.00	-20.14	AVG
11	13.5015	29.02	10.41	39.43	60.00	-20.57	QP
12	13.5015	19.21	10.41	29.62	50.00	-20.38	AVG

EUT	IP Phone	Model Name	X5S
Temperature	25°C	Relative Humidity	53%
Test Voltage	AC 110V/60Hz	Phase	Neutral
Test Mode	Headphone		
Note	Adapter		
Test Engineer	Jason Yang		

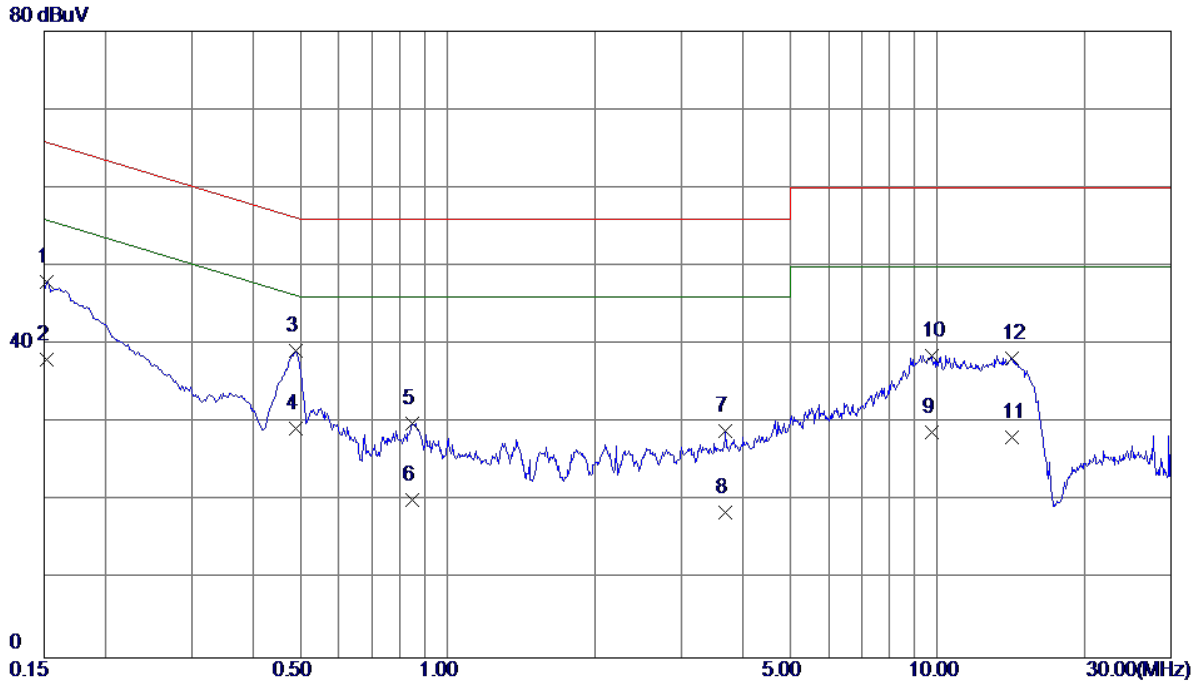

No.	Freq. MHz	Reading Level dBuV	Correct Factor dB	Measure ment dBuV	Limit dBuV	Margin dB	Detector
1	0.1522	38.36	9.66	48.02	65.88	-17.86	QP
2	0.1522	28.40	9.66	38.06	55.88	-17.82	AVG
3	0.4897	29.52	9.72	39.24	56.17	-16.93	QP
4	0.4897	19.60	9.72	29.32	46.17	-16.85	AVG
5	0.8475	20.23	9.74	29.97	56.00	-26.03	QP
6	0.8475	10.40	9.74	20.14	46.00	-25.86	AVG
7	3.6825	18.95	9.95	28.90	56.00	-27.10	QP
8	3.6825	8.60	9.95	18.55	46.00	-27.45	AVG
9	9.7193	18.49	10.33	28.82	60.00	-31.18	QP
10 *	9.7193	28.29	10.33	38.62	50.00	-11.38	AVG
11	14.1878	17.61	10.52	28.13	60.00	-31.87	QP
12	14.1878	27.75	10.52	38.27	50.00	-11.73	AVG

4.3 ASYMMETRIC MODE CONDUCTED EMISSIONS TEST

4.3.1 LIMITS

Requirements for asymmetric mode conducted emissions from Class A equipment

Table clause	Frequency range MHz	Coupling device	Detector type / Bandwidth	Class A voltage limits dB(μV)	Class A current limits dB(μV)
A11.1	0.15 – 0.5	AAN	Quasi Peak / 9 kHz	97 – 87	n/a
	0.5 – 30			87	
	0.15 – 0.5	AAN	Average / 9 kHz	84 – 74	
	0.5 – 30			74	
A11.2	0.15 – 0.5	CVP and current probe	Quasi Peak / 9 kHz	97 – 87	53 – 43
	0.5 – 30			87	43
	0.15 – 0.5	CVP and current probe	Average / 9 kHz	84 – 74	40 – 30
	0.5 – 30			74	30
A11.3	0.15 – 0.5	Current probe	Quasi Peak / 9 kHz	n/a	53 – 43
	0.5 – 30				43
	0.15 – 0.5	Current probe	Average / 9 kHz		40 – 30
	0.5 – 30				30

The choice of coupling device and measurement procedure is defined in Annex C.

AC mains ports that also have the function of a wired network port shall meet the limits given in Table A.9. The measurement shall cover the entire frequency range.

The application of the voltage and/or current limits is dependent on the measurement procedure used. Refer to Table C.1 for applicability.

Testing is required at only one EUT supply voltage and frequency.

Applicable to ports listed above and intended to connect to cables longer than 3 m.

Requirements for asymmetric mode conducted emissions from Class B equipment

Table clause	Frequency range MHz	Coupling device	Detector type / Bandwidth	Class B voltage limits dB(μV)	Class B current limits dB(μV)
A12.1	0.15 – 0.5	AAN	Quasi Peak / 9 kHz	84 – 74	n/a
	0.5 – 30			74	
	0.15 – 0.5	AAN	Average / 9 kHz	74 – 64	
	0.5 – 30			64	
A12.2	0.15 – 0.5	CVP and current probe	Quasi Peak / 9 kHz	84 – 74	40 – 30
	0.5 – 30			74	30
	0.15 – 0.5	CVP and current probe	Average / 9 kHz	74 – 64	30 – 20
	0.5 – 30			64	20
A12.3	0.15 – 0.5	Current probe	Quasi Peak / 9 kHz	n/a	40 – 30
	0.5 – 30				30
	0.15 – 0.5	Current probe	Average / 9 kHz		30 – 20
	0.5 – 30				20

The choice of coupling device and measurement procedure is defined in Annex C.

Screened ports including TV broadcast receiver tuner ports are measured with a common-mode impedance of 150 Ω. This is typically accomplished with the screen terminated by 150 Ω to earth.

AC mains ports that also have the function of a wired network port shall meet the limits given in Table A.10.

The measurement shall cover the entire frequency range.

The application of the voltage and/or current limits is dependent on the measurement procedure used. Refer to Table C.1 for applicability.

Measurement is required at only one EUT supply voltage and frequency.

Applicable to ports listed above and intended to connect to cables longer than 3 m.

NOTE:

(1) The test result calculated as following:

Measurement Value = Reading Level + Correct Factor

Correct Factor = Insertion Loss + Cable Loss + Attenuator Factor(if use)

Margin Level = Measurement Value – Limit Value

4.3.2 MEASUREMENT INSTRUMENTS LIST

Item	Kind of Equipment	Manufacturer	Type No.	Serial No.	Calibrated until
1	50Ω Terminator	SHX	TF2-3G-A	8122901	Mar. 26, 2018
2	TWO-LINE V-NETWORK	R&S	ENV216	100526	Mar. 26, 2018
3	EMI Test Receiver	R&S	ESR3	101862	Sep. 04, 2017
4	Artificial-Mains Network	SCHWARZBECK	NSLK 8127	8127685	Sep. 04, 2017
5	Cable	N/A	RG400 12m	N/A	Mar. 07, 2018
6	Measurement Software	Farad	EZ-EMC Ver.NB-03A 1-01	N/A	N/A
7	ISN	Teseq GmbH	ISN T8	30833	Oct. 21, 2017
8	ISN	FCC	FCC-TLISN -T2-02	20433	Jun. 20, 2018

Remark: "N/A" denotes no model name, no serial No. or no calibration specified.
All calibration period of equipment list is one year.

4.3.3 TEST PROCEDURE

- a. The EUT was placed 0.8 meters from the horizontal ground plane with EUT being connected to the power mains through a line impedance stabilization network (LISN). All other support equipment powered from additional LISN(s). The LISN provide 50 Ohm/ 50uH of coupling impedance for the measuring instrument.
- b. Interconnecting cables that hang closer than 40 cm to the ground plane shall be folded back and forth in the center forming a bundle 30 to 40 cm long.
- c. I/O cables that are not connected to a peripheral shall be bundled in the center. The end of the cable may be terminated, if required, using the correct terminating impedance. The overall length shall not exceed 1 m.
- d. For the actual test configuration, please refer to the related Item –EUT Test Photos.
- e. **AAN, CP or CVP** at least 80 cm from nearest part of EUT chassis.

NOTE:

- f. The communication function of EUT was executed and AAN was connected between EUT and associated equipment and the AAN was connected directly to reference ground plane.
Measure the voltage at the measurement port of the AAN
Correct the measured voltage by adding the AAN voltage division factor
Compare the corrected voltage with the limit(**For AAN**)
- g Measure the current with a current probe and compare to the current limit(**For CP**)
- h The current shall be measured with the current probe and the results compared with the current limits.
The voltage measured shall be corrected at each frequency of interest as follows:
- if the current margin with respect to the current limit is ≤ 6 dB, the actual current margin shall be subtracted from the measured voltage;
-if the current margin with respect to the current limit is >6 dB, 6 dB shall be subtracted from the measured voltage.
The adjusted voltage shall be compared with the applicable voltage limit.
Both the measured current and the corrected voltage shall be below the applicable current and voltage limits at all frequencies for the EUT to be deemed compliant with this publication.(**For CVP**)

4.3.4 DEVIATION FROM TEST STANDARD

No deviation

4.3.5 TEST SETUP

a) Cable Type: Balanced Unscreened, Screened or Coaxial

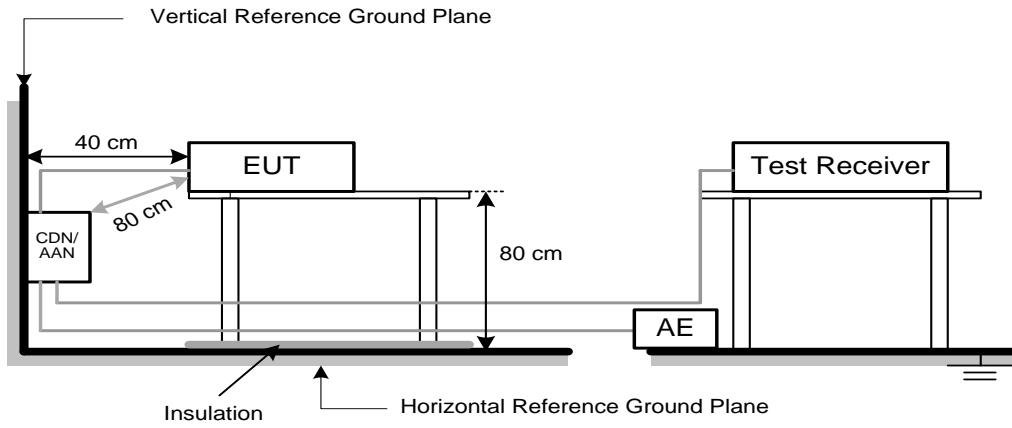

b) Cable Type: Screened or Coaxial

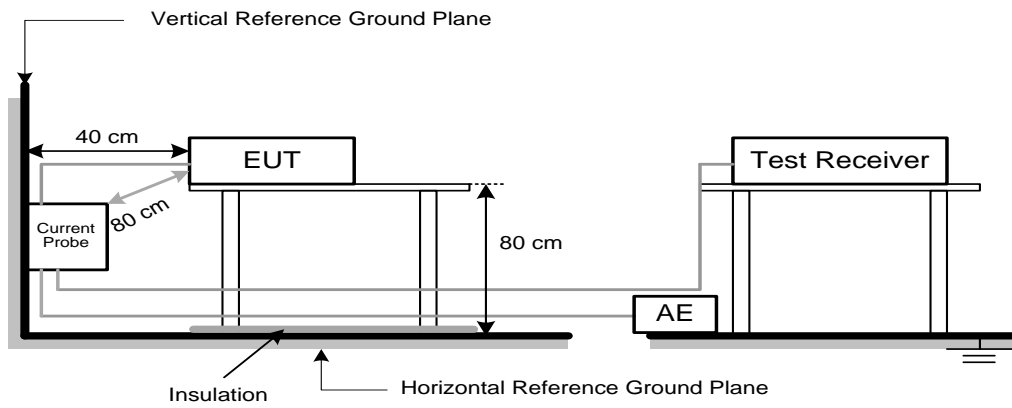

c) Cable Type: Balanced Unscreened, Unbalanced

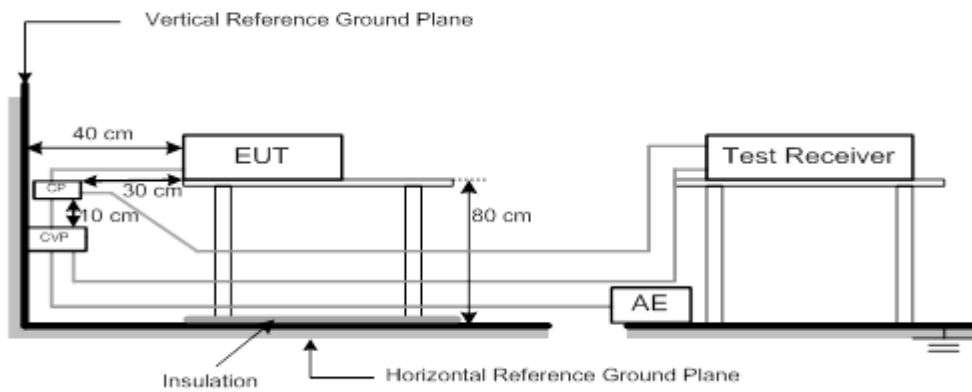

4.3.6 TEST RESULTS

EUT	IP Phone	Model Name	X5S
Temperature	25°C	Relative Humidity	53%
Test Voltage	AC 230V/50Hz		
Test Mode	PC Port 1Gbps		
Note	Adapter		
Test Engineer	Jason Yang		

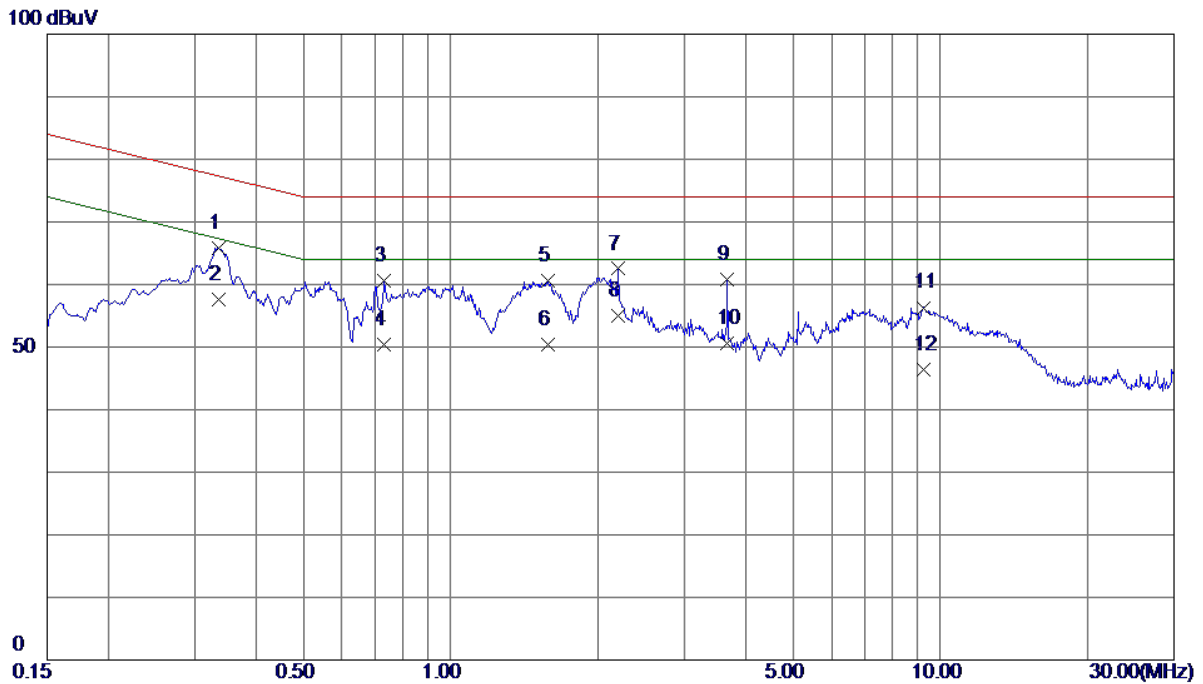

No.	Freq. MHz	Reading Level dBuV	Correct Factor dB	Measure ment dBuV	Limit dBuV	Margin dB	Detector
1	0.3367	55.92	9.91	65.83	77.28	-11.45	QP
2	0.3367	47.60	9.91	57.51	67.28	-9.77	AVG
3	0.7327	50.76	9.82	60.58	74.00	-13.42	QP
4	0.7327	40.59	9.82	50.41	64.00	-13.59	AVG
5	1.5809	50.87	9.78	60.65	74.00	-13.35	QP
6	1.5809	40.70	9.78	50.48	64.00	-13.52	AVG
7	2.2020	52.72	9.78	62.50	74.00	-11.50	QP
8 *	2.2020	45.20	9.78	54.98	64.00	-9.02	AVG
9	3.6690	50.91	9.81	60.72	74.00	-13.28	QP
10	3.6690	40.81	9.81	50.62	64.00	-13.38	AVG
11	9.2423	46.27	10.03	56.30	74.00	-17.70	QP
12	9.2423	36.30	10.03	46.33	64.00	-17.67	AVG

EUT	IP Phone	Model Name	X5S
Temperature	25°C	Relative Humidity	53%
Test Voltage	DC 48V		
Test Mode	PC Port 1Gbps		
Note	PoE		
Test Engineer	Jason Yang		

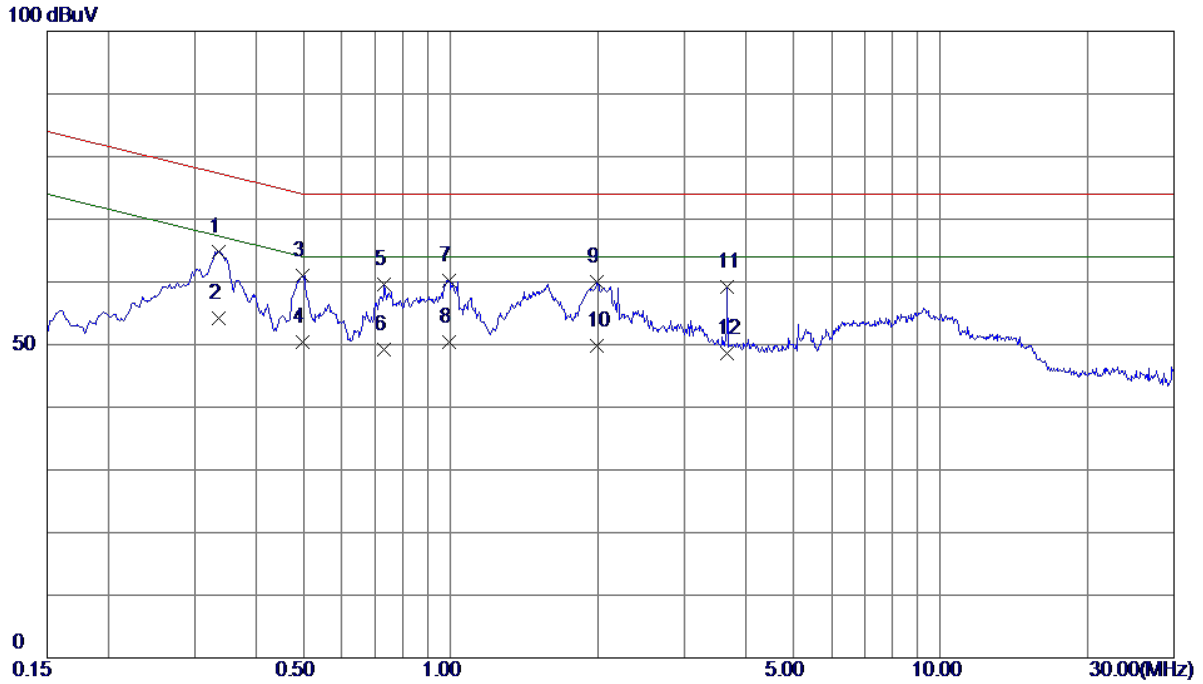

No.	Freq. MHz	Reading Level dBuV	Correct Factor dB	Measure ment dBuV	Limit dBuV	Margin dB	Detector
1 *	0.3366	54.92	9.91	64.83	77.29	-12.46	QP
2	0.3366	44.31	9.91	54.22	67.29	-13.07	AVG
3	0.4986	51.14	9.85	60.99	74.02	-13.03	QP
4	0.4986	40.47	9.85	50.32	64.02	-13.70	AVG
5	0.7327	49.76	9.82	59.58	74.00	-14.42	QP
6	0.7327	39.46	9.82	49.28	64.00	-14.72	AVG
7	0.9937	50.43	9.79	60.22	74.00	-13.78	QP
8	0.9937	40.69	9.79	50.48	64.00	-13.52	AVG
9	1.9926	50.27	9.78	60.05	74.00	-13.95	QP
10	1.9926	40.03	9.78	49.81	64.00	-14.19	AVG
11	3.6690	49.41	9.81	59.22	74.00	-14.78	QP
12	3.6690	38.86	9.81	48.67	64.00	-15.33	AVG

EUT	IP Phone	Model Name	X5S
Temperature	25°C	Relative Humidity	53%
Test Voltage	AC 230V/50Hz		
Test Mode	PC Port 100Mbps		
Note	Adapter		
Test Engineer	Jason Yang		

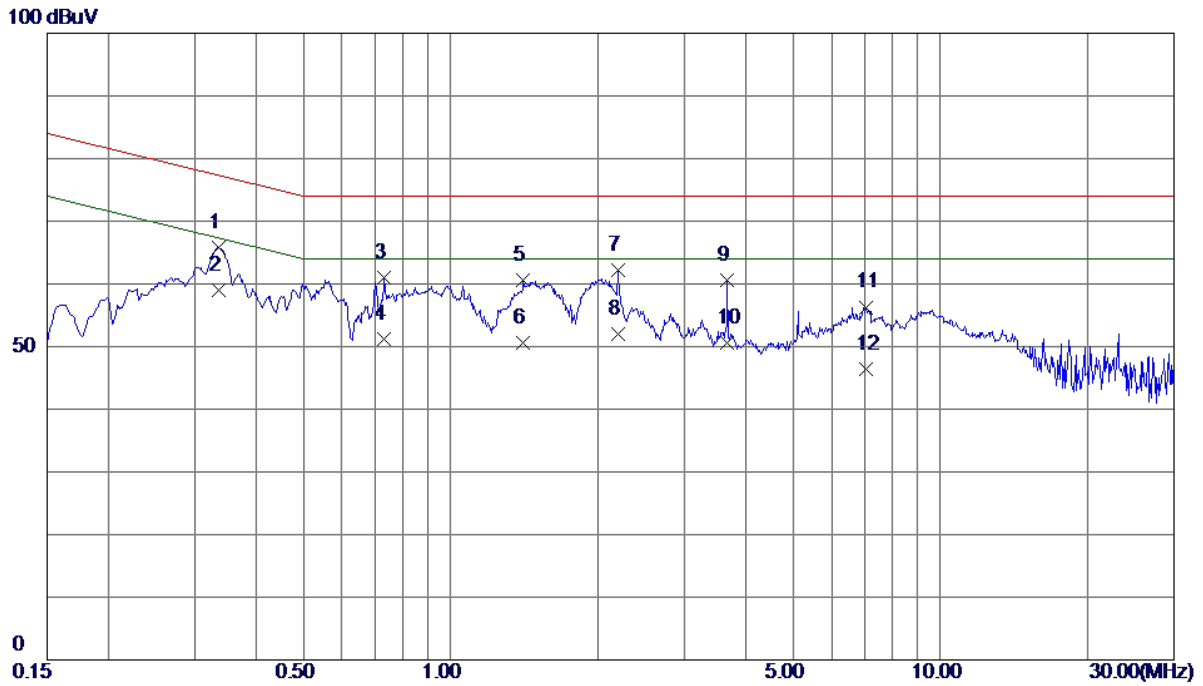

No.	Freq. MHz	Reading Level dBuV	Correct Factor dB	Measure ment dBuV	Limit dBuV	Margin dB	Detector
1	0.3367	55.94	9.91	65.85	77.28	-11.43	QP
2 *	0.3367	49.10	9.91	59.01	67.28	-8.27	AVG
3	0.7327	51.25	9.82	61.07	74.00	-12.93	QP
4	0.7327	41.29	9.82	51.11	64.00	-12.89	AVG
5	1.4078	50.90	9.79	60.69	74.00	-13.31	QP
6	1.4078	40.80	9.79	50.59	64.00	-13.41	AVG
7	2.1998	52.35	9.78	62.13	74.00	-11.87	QP
8	2.1998	42.30	9.78	52.08	64.00	-11.92	AVG
9	3.6668	50.82	9.81	60.63	74.00	-13.37	QP
10	3.6668	40.71	9.81	50.52	64.00	-13.48	AVG
11	7.0440	46.35	9.95	56.30	74.00	-17.70	QP
12	7.0440	36.40	9.95	46.35	64.00	-17.65	AVG

EUT	IP Phone	Model Name	X5S
Temperature	25°C	Relative Humidity	53%
Test Voltage	AC 230V/50Hz		
Test Mode	PC Port 10Mbps		
Note	Adapter		
Test Engineer	Jason Yang		

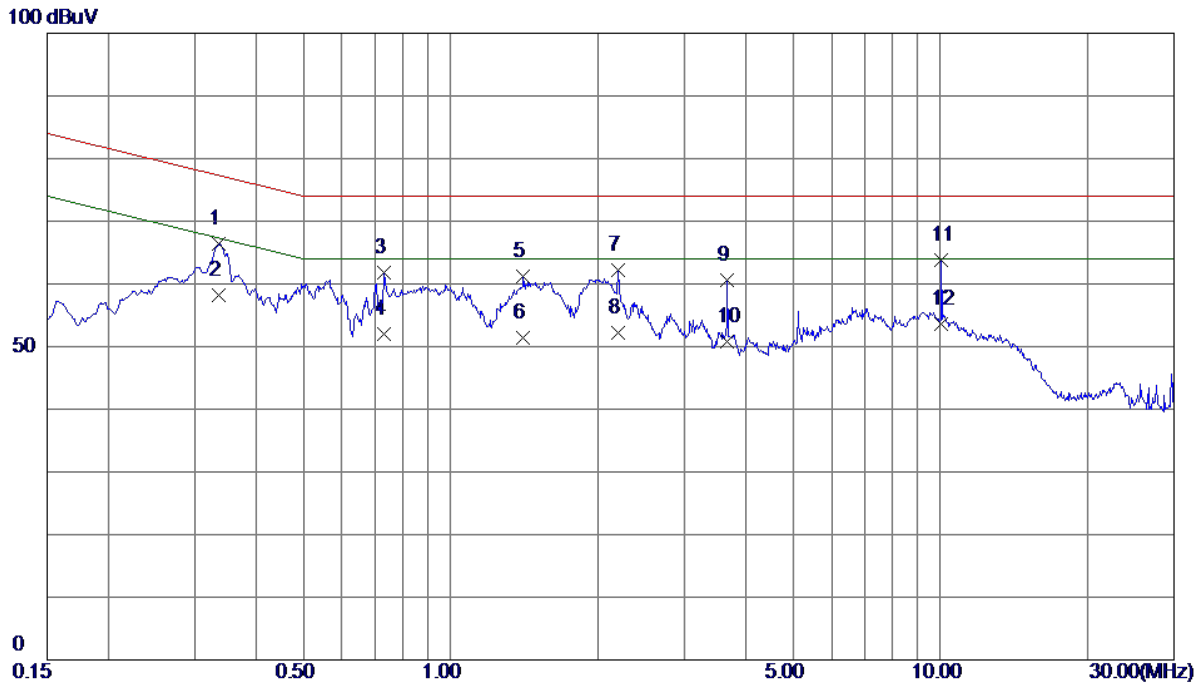

No.	Freq. MHz	Reading Level dBuV	Correct Factor dB	Measure ment dBuV	Limit dBuV	Margin dB	Detector
1	0.3367	56.44	9.91	66.35	77.28	-10.93	QP
2 *	0.3367	48.20	9.91	58.11	67.28	-9.17	AVG
3	0.7327	51.99	9.82	61.81	74.00	-12.19	QP
4	0.7327	42.09	9.82	51.91	64.00	-12.09	AVG
5	1.4078	51.50	9.79	61.29	74.00	-12.71	QP
6	1.4078	41.60	9.79	51.39	64.00	-12.61	AVG
7	2.1998	52.34	9.78	62.12	74.00	-11.88	QP
8	2.1998	42.40	9.78	52.18	64.00	-11.82	AVG
9	3.6668	50.81	9.81	60.62	74.00	-13.38	QP
10	3.6668	40.91	9.81	50.72	64.00	-13.28	AVG
11	10.0365	53.74	10.06	63.80	74.00	-10.20	QP
12	10.0365	43.60	10.06	53.66	64.00	-10.34	AVG

EUT	IP Phone	Model Name	X5S
Temperature	25°C	Relative Humidity	53%
Test Voltage	AC 230V/50Hz		
Test Mode	Internet Port 1Gbps		
Note	Adapter		
Test Engineer	Jason Yang		

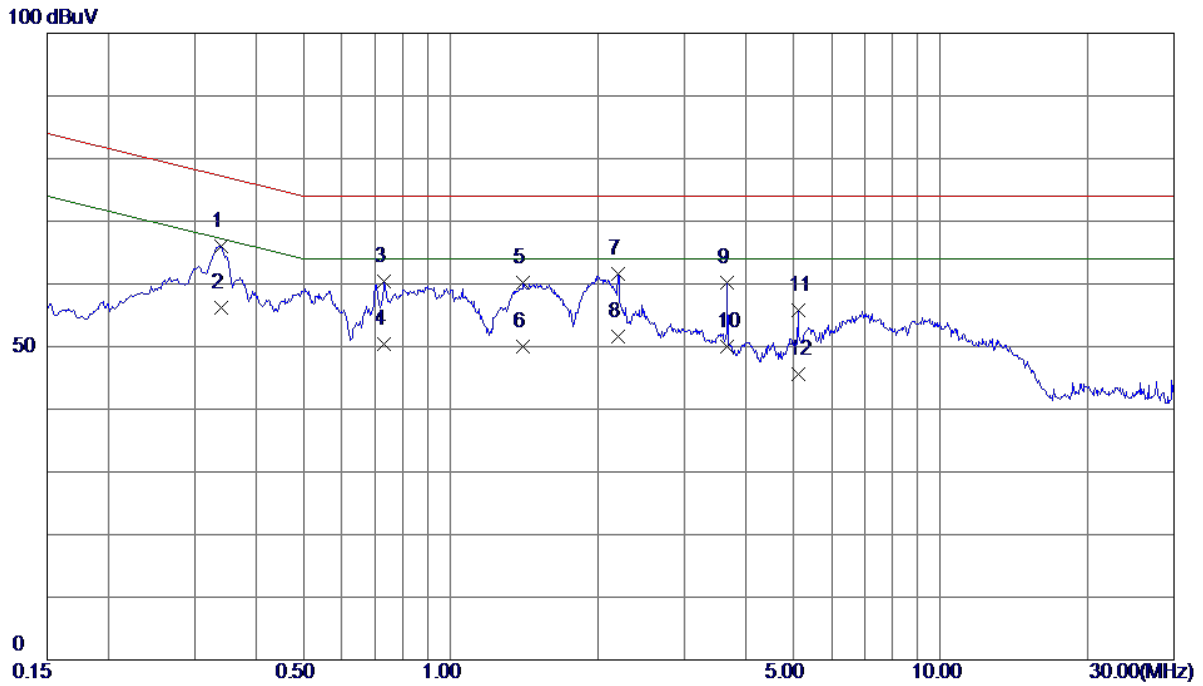

No.	Freq. MHz	Reading Level dBuV	Correct Factor dB	Measure ment dBuV	Limit dBuV	Margin dB	Detector
1	0.3390	56.14	9.91	66.05	77.23	-11.18	QP
2 *	0.3390	46.20	9.91	56.11	67.23	-11.12	AVG
3	0.7327	50.61	9.82	60.43	74.00	-13.57	QP
4	0.7327	40.49	9.82	50.31	64.00	-13.69	AVG
5	1.4055	50.33	9.79	60.12	74.00	-13.88	QP
6	1.4055	40.30	9.79	50.09	64.00	-13.91	AVG
7	2.1998	51.84	9.78	61.62	74.00	-12.38	QP
8	2.1998	41.80	9.78	51.58	64.00	-12.42	AVG
9	3.6668	50.32	9.81	60.13	74.00	-13.87	QP
10	3.6668	40.21	9.81	50.02	64.00	-13.98	AVG
11	5.1359	45.96	9.87	55.83	74.00	-18.17	QP
12	5.1359	35.80	9.87	45.67	64.00	-18.33	AVG

EUT	IP Phone	Model Name	X5S
Temperature	25°C	Relative Humidity	53%
Test Voltage	DC 48V		
Test Mode	Internet Port 1Gbps		
Note	PoE		
Test Engineer	Jason Yang		

100 dBuV

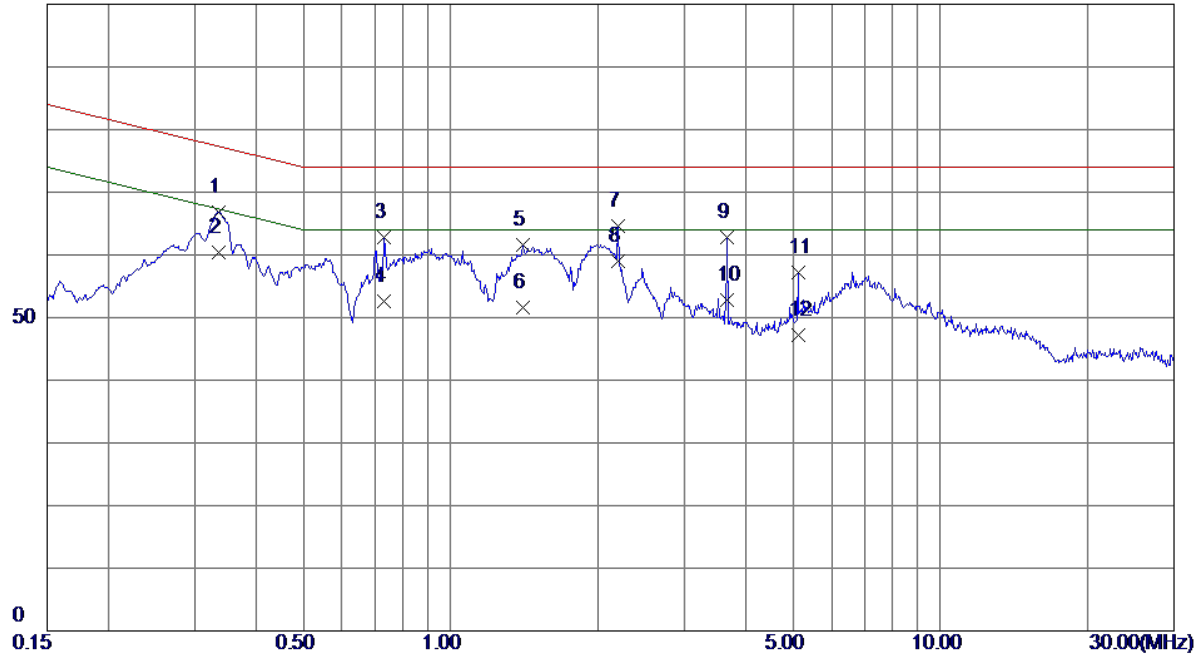

No.	Freq. MHz	Reading Level dBuV	Correct Factor dB	Measure ment dBuV	Limit dBuV	Margin dB	Detector
1	0.3367	56.95	9.91	66.86	77.28	-10.42	QP
2	0.3367	50.50	9.91	60.41	67.28	-6.87	AVG
3	0.7327	52.92	9.82	62.74	74.00	-11.26	QP
4	0.7327	42.79	9.82	52.61	64.00	-11.39	AVG
5	1.4078	51.87	9.79	61.66	74.00	-12.34	QP
6	1.4078	41.80	9.79	51.59	64.00	-12.41	AVG
7	2.1998	54.78	9.78	64.56	74.00	-9.44	QP
8 *	2.1998	49.30	9.78	59.08	64.00	-4.92	AVG
9	3.6668	53.01	9.81	62.82	74.00	-11.18	QP
10	3.6668	43.01	9.81	52.82	64.00	-11.18	AVG
11	5.1315	47.34	9.87	57.21	74.00	-16.79	QP
12	5.1315	37.40	9.87	47.27	64.00	-16.73	AVG

EUT	IP Phone	Model Name	X5S
Temperature	25°C	Relative Humidity	53%
Test Voltage	AC 230V/50Hz		
Test Mode	Internet Port 100Mbps		
Note	Adapter		
Test Engineer	Jason Yang		

100 dBuV

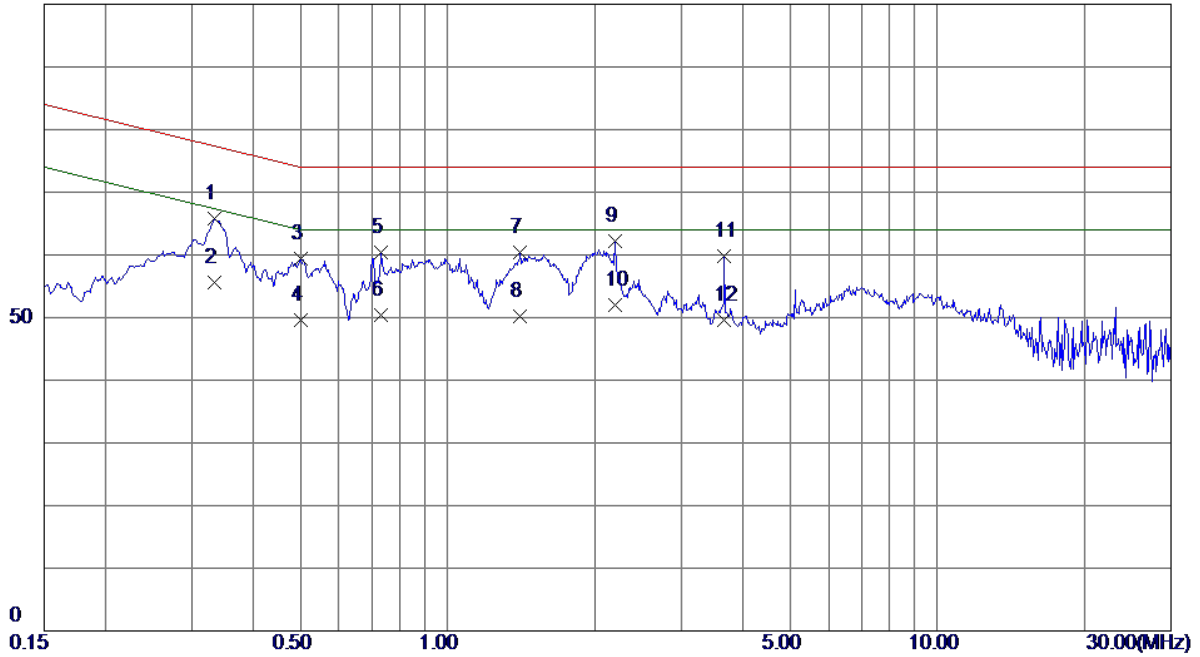

No.	Freq. MHz	Reading Level dBuV	Correct Factor dB	Measure ment dBuV	Limit dBuV	Margin dB	Detector
1 *	0.3345	55.88	9.92	65.80	77.34	-11.54	QP
2	0.3345	45.69	9.92	55.61	67.34	-11.73	AVG
3	0.5010	49.62	9.85	59.47	74.00	-14.53	QP
4	0.5010	39.70	9.85	49.55	64.00	-14.45	AVG
5	0.7327	50.63	9.82	60.45	74.00	-13.55	QP
6	0.7327	40.59	9.82	50.41	64.00	-13.59	AVG
7	1.4033	50.62	9.79	60.41	74.00	-13.59	QP
8	1.4033	40.50	9.79	50.29	64.00	-13.71	AVG
9	2.1998	52.42	9.78	62.20	74.00	-11.80	QP
10	2.1998	42.30	9.78	52.08	64.00	-11.92	AVG
11	3.6668	49.96	9.81	59.77	74.00	-14.23	QP
12	3.6668	39.81	9.81	49.62	64.00	-14.38	AVG

EUT	IP Phone	Model Name	X5S
Temperature	25°C	Relative Humidity	53%
Test Voltage	DC 48V		
Test Mode	Internet Port 100Mbps		
Note	PoE		
Test Engineer	Jason Yang		

100 dBuV

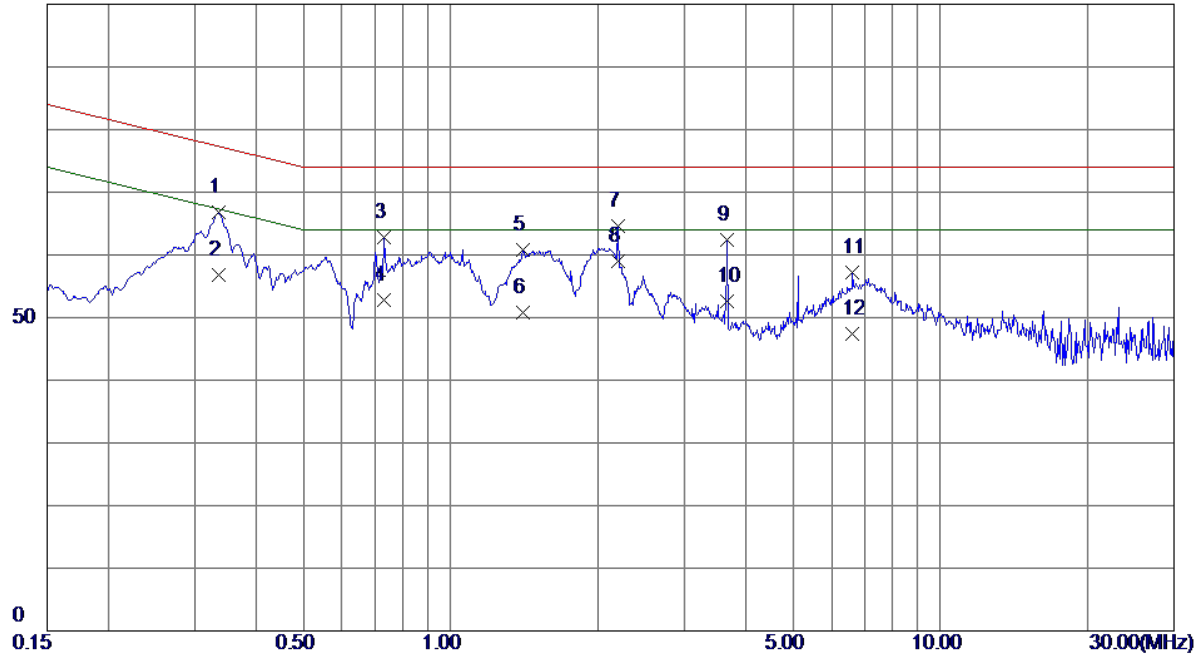

No.	Freq. MHz	Reading Level dBuV	Correct Factor dB	Measure ment dBuV	Limit dBuV	Margin dB	Detector
1	0.3367	56.90	9.91	66.81	77.28	-10.47	QP
2	0.3367	46.80	9.91	56.71	67.28	-10.57	AVG
3	0.7327	52.97	9.82	62.79	74.00	-11.21	QP
4	0.7327	42.89	9.82	52.71	64.00	-11.29	AVG
5	1.4078	51.09	9.79	60.88	74.00	-13.12	QP
6	1.4078	41.10	9.79	50.89	64.00	-13.11	AVG
7	2.1998	54.88	9.78	64.66	74.00	-9.34	QP
8 *	2.1998	49.30	9.78	59.08	64.00	-4.92	AVG
9	3.6668	52.68	9.81	62.49	74.00	-11.51	QP
10	3.6668	42.71	9.81	52.52	64.00	-11.48	AVG
11	6.5985	47.34	9.93	57.27	74.00	-16.73	QP
12	6.5985	37.40	9.93	47.33	64.00	-16.67	AVG

EUT	IP Phone	Model Name	X5S
Temperature	25°C	Relative Humidity	53%
Test Voltage	AC 230V/50Hz		
Test Mode	Internet Port 10Mbps		
Note	Adapter		
Test Engineer	Jason Yang		

100 dBuV

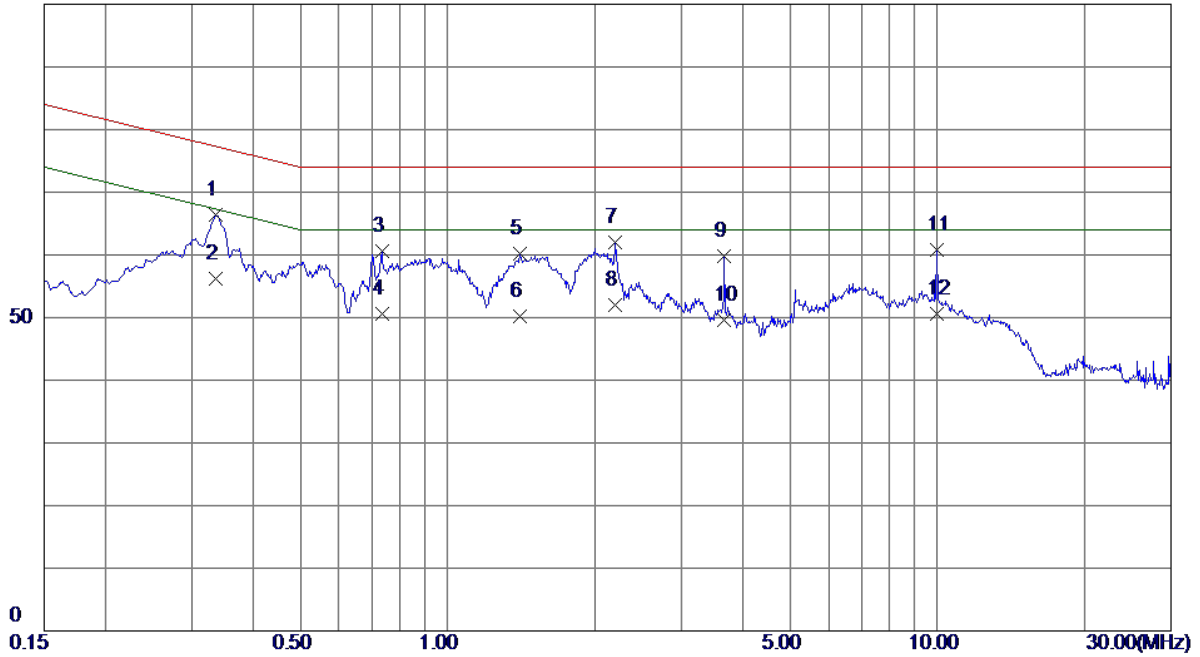

No.	Freq. MHz	Reading Level dBuV	Correct Factor dB	Measure ment dBuV	Limit dBuV	Margin dB	Detector
1 *	0.3367	56.40	9.91	66.31	77.28	-10.97	QP
2	0.3367	46.20	9.91	56.11	67.28	-11.17	AVG
3	0.7350	50.78	9.82	60.60	74.00	-13.40	QP
4	0.7350	40.79	9.82	50.61	64.00	-13.39	AVG
5	1.4078	50.46	9.79	60.25	74.00	-13.75	QP
6	1.4078	40.50	9.79	50.29	64.00	-13.71	AVG
7	2.2020	52.20	9.78	61.98	74.00	-12.02	QP
8	2.2020	42.30	9.78	52.08	64.00	-11.92	AVG
9	3.6668	50.00	9.81	59.81	74.00	-14.19	QP
10	3.6668	39.81	9.81	49.62	64.00	-14.38	AVG
11	9.9690	50.68	10.06	60.74	74.00	-13.26	QP
12	9.9690	40.60	10.06	50.66	64.00	-13.34	AVG

EUT	IP Phone	Model Name	X5S
Temperature	25°C	Relative Humidity	53%
Test Voltage	DC 48V		
Test Mode	Internet Port 10Mbps		
Note	PoE		
Test Engineer	Jason Yang		

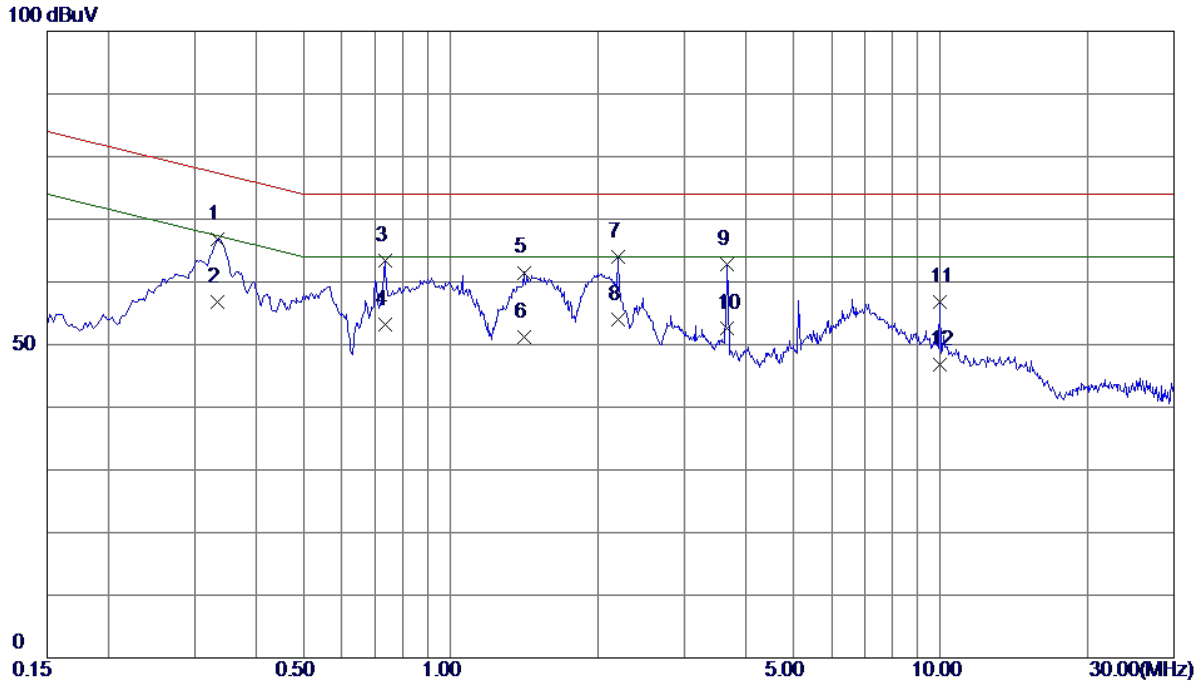

No.	Freq. MHz	Reading Level dBuV	Correct Factor dB	Measure ment dBuV	Limit dBuV	Margin dB	Detector
1	0.3345	56.93	9.92	66.85	77.34	-10.49	QP
2	0.3345	46.89	9.92	56.81	67.34	-10.53	AVG
3	0.7350	53.55	9.82	63.37	74.00	-10.63	QP
4	0.7350	43.39	9.82	53.21	64.00	-10.79	AVG
5	1.4100	51.71	9.79	61.50	74.00	-12.50	QP
6	1.4100	41.50	9.79	51.29	64.00	-12.71	AVG
7	2.1998	54.15	9.78	63.93	74.00	-10.07	QP
8 *	2.1998	44.20	9.78	53.98	64.00	-10.02	AVG
9	3.6645	52.96	9.81	62.77	74.00	-11.23	QP
10	3.6645	42.81	9.81	52.62	64.00	-11.38	AVG
11	10.0004	46.80	10.06	56.86	74.00	-17.14	QP
12	10.0004	36.70	10.06	46.76	64.00	-17.24	AVG

4.4 HARMONIC CURRENT EMISSIONS TEST

4.4.1 LIMITS

EN 61000-3-2						
Equipment Category	Harmonic Order n	Max. Permissible Harmonic Current A	Equipment Category	Harmonic Order n	Max. Permissible Harmonic Current A mA/w	
Class A	Odd Harmonics		Class D	Odd Harmonics only		
	3	2.30		3	2.30	3.4
	5	1.14		5	1.14	1.9
	7	0.77		7	0.77	1.0
	9	0.40		9	0.40	0.5
	11	0.33		11	0.33	0.35
	13	0.21		13	0.21	0.30
	15≤n≤39	0.15 x 15/n		15≤n≤39	0.15 x 15/n	3.85/n
	Even Harmonics					
	2	1.08				
	4	0.43				
	6	0.30				
	8≤n≤40	0.23 x 8/n				

4.4.2 MEASUREMENT INSTRUMENTS LIST

Item	Kind of Equipment	Manufacturer	Type No.	Serial No.	Calibrated until
1	Harmonics and Flicker Analyzer	California Instruments	PACS-1	72344	Aug. 03, 2018
2	3KVA AC Power source	California Instruments	3001ix	56309	Aug. 03, 2018
3	Measurement Software	California	CTS4.0 Version 4.9	N/A	N/A

Remark: "N/A" denotes no model name, no serial No. or no calibration specified.
All calibration period of equipment list is one year.

4.4.3 TEST PROCEDURE

- a. The EUT was placed on the top of a wooden table 0.8 meters above the ground and operated to produce the maximum harmonic components under normal operating conditions.
- b. The classification of EUT is according to of EN 61000-3-2. The EUT is classified as follows:
 - Class A: Balanced three-phase equipment, Household appliances excluding equipment as Class D, Tools excluding portable tools, Dimmers for incandescent lamps, audio equipment, equipment not specified in one of the three other classes.
 - Class B: Portable tools; Arc welding equipment which is not professional equipment.
 - Class C: Lighting equipment.
 - Class D: Equipment having a specified power less than or equal to 600 W of the following types: Personal computers and personal computer monitors and television receivers.
- c. The correspondent test program of test instrument to measure the current harmonics emanated from EUT is chosen. The measure time shall be not less than the time necessary for the EUT to be exercised.

4.4.4 DEVIATION FROM TEST STANDARD

No deviation

4.4.5 TEST SETUP

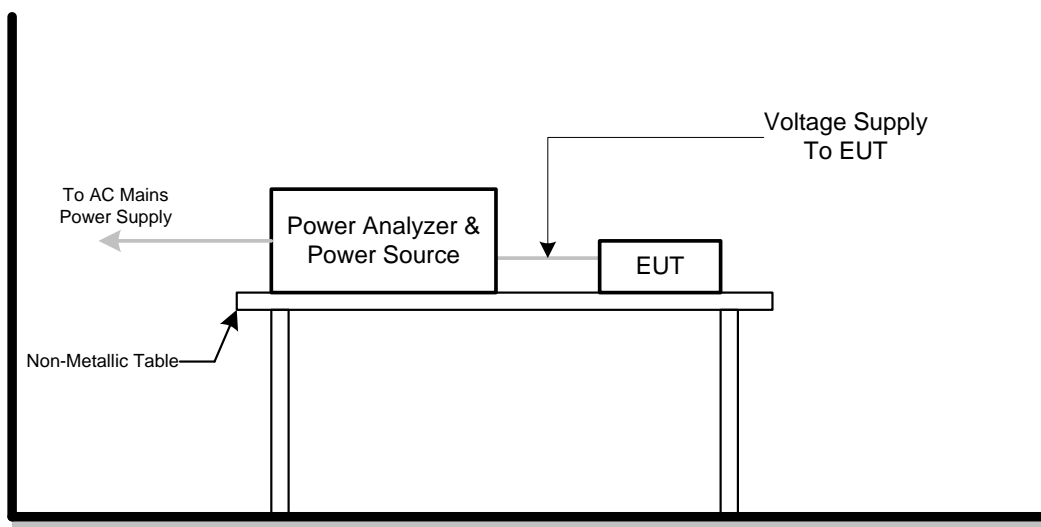

4.4.6 TEST RESULTS

Harmonic - Class A			
EUT	IP Phone	Model Name	X5S
Temperature	25°C	Relative Humidity	55%
Test Voltage	AC 230V/50Hz		
Test Mode	Headphone		

Current & voltage waveforms

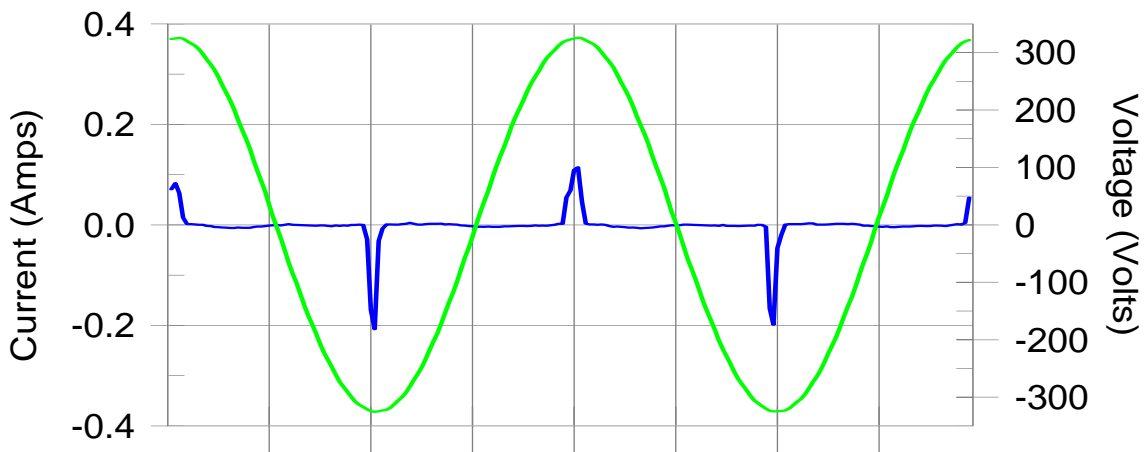

Harmonics and Class A limit line European Limits

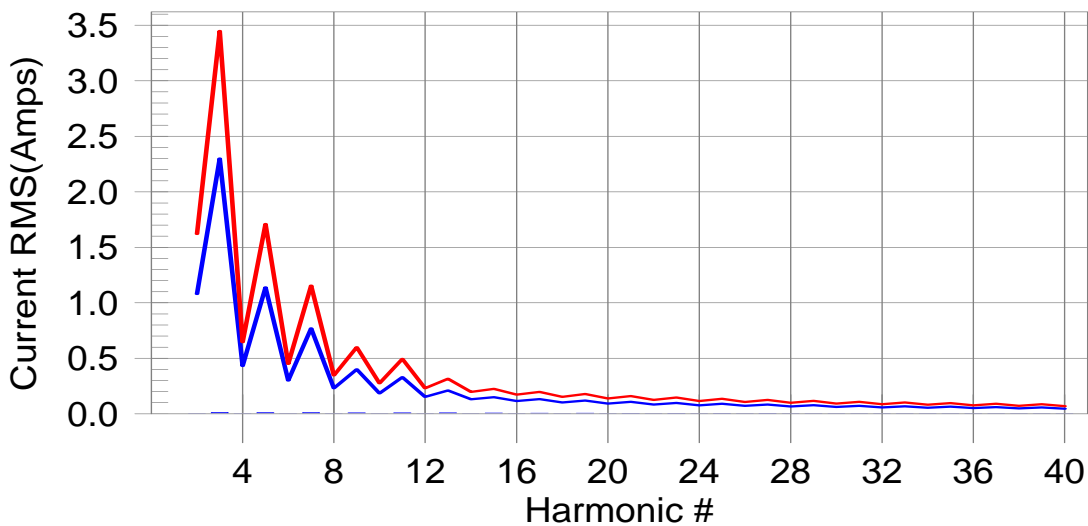

Test result: Pass Worst harmonic was #15 with 3.1% of the limit.

Current Test Result Summary (Run time)			
EUT	IP Phone	Model Name	X5S
Temperature	25°C	Relative Humidity	55%
Test Voltage	AC 230V/50Hz		
Test Mode	Headphone		

Highest parameter values during test:

V_RMS (Volts): 230.07	Frequency(Hz): 50.00
I_Peak (Amps): 0.277	I_RMS (Amps): 0.033
I_Fund (Amps): 0.011	Crest Factor: 8.585
Power (Watts): 2.6	Power Factor: 0.363

Harm#	Harms(avg)	100%Limit	%of Limit	Harms(max)	150%Limit	%of Limit	Status
2	0.001	1.080	N/A	0.002	1.620	N/A	Pass
3	0.010	2.300	0.5	0.012	3.450	0.3	Pass
4	0.001	0.430	N/A	0.001	0.645	N/A	Pass
5	0.010	1.140	0.9	0.010	1.710	0.6	Pass
6	0.000	0.300	N/A	0.001	0.450	N/A	Pass
7	0.010	0.770	1.3	0.010	1.155	0.8	Pass
8	0.000	0.230	N/A	0.001	0.345	N/A	Pass
9	0.009	0.400	2.3	0.009	0.600	1.5	Pass
10	0.000	0.184	N/A	0.001	0.276	N/A	Pass
11	0.008	0.330	2.6	0.009	0.495	1.7	Pass
12	0.000	0.153	N/A	0.001	0.230	N/A	Pass
13	0.008	0.210	3.7	0.008	0.315	2.5	Pass
14	0.000	0.131	N/A	0.000	0.197	N/A	Pass
15	0.007	0.150	4.6	0.007	0.225	3.1	Pass
16	0.000	0.115	N/A	0.000	0.173	N/A	Pass
17	0.006	0.132	4.6	0.006	0.198	3.1	Pass
18	0.000	0.102	N/A	0.000	0.153	N/A	Pass
19	0.005	0.118	4.4	0.005	0.178	3.0	Pass
20	0.000	0.092	N/A	0.000	0.138	N/A	Pass
21	0.004	0.107	N/A	0.004	0.161	N/A	Pass
22	0.000	0.084	N/A	0.000	0.125	N/A	Pass
23	0.004	0.098	N/A	0.004	0.147	N/A	Pass
24	0.000	0.077	N/A	0.000	0.115	N/A	Pass
25	0.003	0.090	N/A	0.003	0.135	N/A	Pass
26	0.000	0.071	N/A	0.000	0.107	N/A	Pass
27	0.002	0.083	N/A	0.002	0.125	N/A	Pass
28	0.000	0.066	N/A	0.000	0.099	N/A	Pass
29	0.002	0.078	N/A	0.002	0.116	N/A	Pass
30	0.000	0.061	N/A	0.000	0.092	N/A	Pass
31	0.001	0.073	N/A	0.001	0.109	N/A	Pass
32	0.000	0.058	N/A	0.000	0.086	N/A	Pass
33	0.001	0.068	N/A	0.001	0.102	N/A	Pass
34	0.000	0.054	N/A	0.000	0.081	N/A	Pass
35	0.001	0.064	N/A	0.001	0.096	N/A	Pass
36	0.000	0.051	N/A	0.000	0.077	N/A	Pass
37	0.001	0.061	N/A	0.001	0.091	N/A	Pass
38	0.000	0.048	N/A	0.000	0.073	N/A	Pass
39	0.001	0.058	N/A	0.001	0.087	N/A	Pass
40	0.000	0.046	N/A	0.000	0.069	N/A	Pass

Voltage Source Verification Data (Run time)			
EUT	IP Phone	Model Name	X5S
Temperature	25°C	Relative Humidity	55%
Test Voltage	AC 230V/50Hz		
Test Mode	Headphone		

Highest parameter values during test:

Voltage (Vrms):230.07	Frequency(Hz): 50.00
I_Peak (Amps):0.277	I_RMS (Amps): 0.033
I_Fund (Amps):0.011	Crest Factor: 8.585
Power (Watts): 2.6	Power Factor: 0.363

Harm#	Harmonics V-rms	Limit V-rms	% of Limit	Status
2	0.112	0.460	24.30	OK
3	0.630	2.070	30.42	OK
4	0.060	0.460	12.97	OK
5	0.128	0.920	13.91	OK
6	0.025	0.460	5.52	OK
7	0.025	0.690	3.61	OK
8	0.018	0.460	3.89	OK
9	0.028	0.460	6.10	OK
10	0.022	0.460	4.68	OK
11	0.022	0.230	9.43	OK
12	0.015	0.230	6.56	OK
13	0.020	0.230	8.81	OK
14	0.011	0.230	4.62	OK
15	0.016	0.230	6.83	OK
16	0.016	0.230	7.16	OK
17	0.006	0.230	2.68	OK
18	0.010	0.230	4.15	OK
19	0.015	0.230	6.45	OK
20	0.015	0.230	6.59	OK
21	0.015	0.230	6.59	OK
22	0.014	0.230	5.99	OK
23	0.012	0.230	5.15	OK
24	0.007	0.230	3.01	OK
25	0.006	0.230	2.70	OK
26	0.009	0.230	4.03	OK
27	0.011	0.230	4.68	OK
28	0.007	0.230	2.84	OK
29	0.007	0.230	2.98	OK
30	0.006	0.230	2.61	OK
31	0.004	0.230	1.67	OK
32	0.006	0.230	2.50	OK
33	0.004	0.230	1.65	OK
34	0.004	0.230	1.56	OK
35	0.007	0.230	3.15	OK
36	0.004	0.230	1.53	OK
37	0.006	0.230	2.66	OK
38	0.003	0.230	1.13	OK
39	0.004	0.230	1.58	OK
40	0.005	0.230	2.36	OK

4.5 VOLTAGE CHANGES, VOLTAGE FLUCTUATIONS AND FLICKER TEST

4.5.1 LIMITS

Tests	Limits	Descriptions
	EN 61000-3-3	
Pst	≤ 1.0 , $T_p= 10$ min.	Short Term Flicker Indicator
Plt	≤ 0.65 , $T_p=2$ hr.	Long Term Flicker Indicator
dc	$\leq 3.3\%$	Relative Steady-State V-Chang
dmax	$\leq 4\%$	Maximum Relative V-change
d (t)	$\leq 3.3\%$ for > 500 ms	Relative V-change characteristic

4.5.2 MEASUREMENT INSTRUMENTS LIST

Item	Kind of Equipment	Manufacturer	Type No.	Serial No.	Calibrated until
1	Harmonics and Flicker Analyzer	California Instruments	PACS-1	72344	Aug. 04, 2017
2	3KVA AC Power source	California Instruments	3001ix	56309	Aug. 04, 2017
3	Measurement Software	California	CTS4.0 Version 4.9	N/A	N/A

Remark: "N/A" denotes no model name, no serial No. or no calibration specified.

All calibration period of equipment list is one year.

4.5.3 TEST PROCEDURE

- a. Tests was performed according to the Test Conditions/Assessment of Voltage Fluctuations specified in EN 61000-3-3 depend on which standard adopted for compliance measurement.
- b. All types of harmonic current and/or voltage fluctuation in this report are assessed by direct measurement using flicker-meter.

4.5.4 DEVIATION FROM TEST STANDARD

No deviation

4.5.5 TESTSETUP

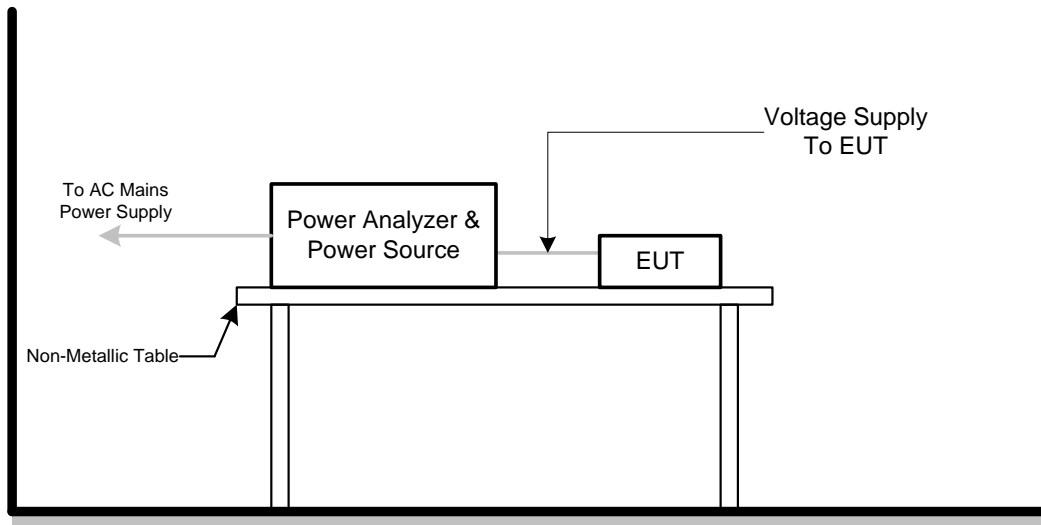

4.5.6 TEST RESULTS

EUT	IP Phone	Model Name	X5S
Temperature	25°C	Relative Humidity	55%
Test Voltage	AC 230V/50Hz		
Test Mode	Headphone		

Psti and limit line

European Limits

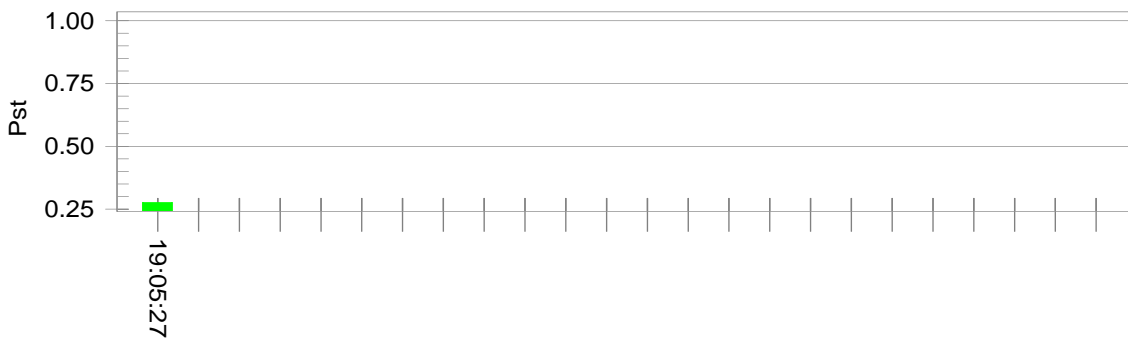

Plt and limit line



Parameter values recorded during the test:

Vrms at the end of test (Volt):230.00

Highest dt (%):	0.00	Test limit (%):	N/A	N/A
T-max (mS):	0	Test limit (mS):	500.0	Pass
Highest dc (%):	0.00	Test limit (%):	3.30	Pass
Highest dmax (%):	-0.05	Test limit (%):	4.00	Pass
Highest Pst (10 min. period):	0.277	Test limit:	1.000	Pass
Highest Plt (2 hr. period):	0.121	Test limit:	0.650	Pass

5. EMC IMMUNITY TEST

5.1 STANDARD COMPLIANCE/SEVERITY LEVEL/CRITERIA

Tests Standard No.	Test Specification Level / Test Mode	Test Ports	Criteria
Electrostatic discharge EN 61000-4-2 (ESD)	±8 kV air discharge ±4 kV contact discharge (Direct Mode)	Enclosure	B
	±4kV HCP discharge ±4kV VCP discharge (Indirect Mode)	Enclosure	B
Radiated, radio-frequency, electromagnetic field immunity EN 61000-4-3 (RS)	80 MHz to 1000 MHz 3V/m(unmodulated, r.m.s), 1 kHz, 80%, AM modulated	Enclosure	A
Electrical fast transient/burst immunity EN 61000-4-4 (EFT/Burst)	±0.5kV(peak) 5/50ns Tr/Th 5kHz Repetition Frequency (100kHz Repetition Frequency for xDSL equipment)	Signal ports and telecommunication ports (Only applicable to cable length>3 m)	B
	±0.5kV(peak) 5/50ns Tr/Th 5kHz Repetition Frequency	DC Power Ports	B
	±1 kV(peak) 5/50ns Tr/Th 5kHz Repetition Frequency	AC Power Ports	B
Surge immunity EN 61000-4-5 (Surges)	±1 kV(peak) 10/700 Tr/Th μs(NOTE) (without primary protection)	Signal ports and telecommunication ports (applicable only to ports connect directly to outdoor cables)	C
	±4 kV(peak) 10/700 Tr/Th μs(NOTE) (with primary protectors fitted)		C
	±0.5 kV(peak) 1.2/50(8/20) Tr/Th μs	DC Power Ports (applicable only to ports connect directly to outdoor cables)	B
	±1 kV(peak) 1.2/50(8/20) Tr/Th μs (line to line)	AC Power Ports	B
	±2 kV(peak) 1.2/50(8/20) Tr/Th μs (line to earth or ground)		B

Immunity to conducted disturbances, induced by radio-frequency fields EN 61000-4-6 (Injected Current)	0.15 MHz to 80 MHz 3V(unmodulated, r.m.s), 1kHz 80%, AM 150Ω source impedance	Signal ports and telecommunication ports (Only applicable to cable length>3 m)	A
	0.15 MHz to 80 MHz 3V(unmodulated, r.m.s), 1kHz 80%, AM 150Ω source impedance	DC Power Ports	A
	0.15 MHz to 80 MHz 3V(unmodulated, r.m.s), 1kHz 80%, AM 150Ω source impedance	AC Power Ports	A
Power frequency magnetic field immunity EN 61000-4-8 (PFMF)	50 Hz or 60Hz, 1A/m(r.m.s) μs	Enclosure	A
Voltage dips, short interruptions and voltage variations immunity EN 61000-4-11 (Voltage Interruption/Dips)	Voltage reduction > 95% 0.5 period Voltage reduction 30% 25 periods Voltage reduction > 95% 250 periods	AC Power Ports	B C C

Note.

Where the coupling network for the 10/700 μs waveform affects the functioning of high speed data ports, the test shall be carried out using a 1,2/50 (8/20) μs waveform and appropriate coupling network.

5.2 GENERAL PERFORMANCE CRITERIA

According to **EN55024** standard, the general performance criteria as following:

<p>Criterion A</p>	<p>The equipment shall continue to operate as intended without operator intervention. No degradation of performance or loss of function is allowed below a performance level specified by the manufacturer when the equipment is used as intended. The performance level may be replaced by a permissible loss of performance.</p> <p>If the minimum performance level or the permissible performance loss is not specified by the manufacturer, then either of these may be derived from the product description and documentation, and by what the user product description and documentation, and by what the user may reasonably expect from the equipment if used as intended.</p>
<p>Criterion B</p>	<p>After the test, the equipment shall continue to operate as intended without operator intervention. No degradation of performance or loss of function is allowed, after the application of the phenomenon below a performance level specified by the manufacturer, when the equipment is used as intended. The performance level may be replaced by a permissible loss of performance.</p> <p>During the test, degradation of performance is allowed. However, no change of operating state if stored data allowed to persist after the test. If the minimum performance level (or the permissible performance loss) is not specified by the manufacturer, then either of these may be derived from the product description and documentation, and by what the user may reasonably expect from the equipment if used as intended.</p>
<p>Criterion C</p>	<p>Loss of function is allowed, provided the function is self-recoverable, or can be restored by the operation of the controls by the user in accordance with the manufacturer's instructions.</p> <p>Functions, and/or information stored in non-volatile memory, or protected by a battery backup, shall not be lost.</p>

5.3 ELECTROSTATIC DISCHARGE IMMUNITY TEST (ESD)

5.3.1 TEST SPECIFICATION

Basic Standard	EN 61000-4-2
Discharge Impedance	330 ohm / 150 pF
Required Performance	B
Discharge Voltage	Air Discharge: ± 2 kV, ± 4 kV, ± 8 kV (Direct) Contact Discharge: ± 2 kV, ± 4 kV (Direct/Indirect)
Polarity	Positive & Negative
Number of Discharge	Air Discharge: min. 20 times at each test point Contact Discharge: min. 200 times in total
Discharge Mode	Single Discharge
Discharge Period	1 second minimum

5.3.2 MEASUREMENT INSTRUMENTS

Item	Kind of Equipment	Manufacturer	Type No.	Serial No.	Calibrated until
1	ESD Generator	TESEQ AG	NSG 437	450	Nov. 03, 2017

Remark: "N/A" denotes no model name, no serial No. or no calibration specified.

All calibration period of equipment list is one year.

5.3.3 TEST PROCEDURE

The test generator necessary to perform direct and indirect application of discharges to the EUT in the following manner:

- a. Contact discharge was applied to conductive surfaces (Direct) and coupling planes (Indirect) of the EUT.

During the test, it was performed with single discharges. For the single discharge time between successive single discharges was at least 1 second. The EUT shall be exposed to at least 200 discharges, 100 each at negative and positive polarity, at a minimum of four test points. One of the test points shall be subjected to at least 50 indirect discharges to the center of the front edge of the horizontal coupling plane. The remaining three test points shall each receive at least 50 direct contact discharges.

If no direct contact test points are available, then at least 200 indirect discharges shall be applied in the indirect mode. Test shall be performed at a maximum repetition rate of one discharge per second.

Vertical Coupling Plane (VCP):

The coupling plane, of dimensions 0.5m x 0.5m, is placed parallel to, and positioned at a distance 0.1m from, the EUT, with the Discharge Electrode touching the coupling plane.

The four faces of the EUT will be performed with electrostatic discharge.

Horizontal Coupling Plane (HCP):

The coupling plane is placed under to the EUT. The generator shall be positioned vertically at a distance of 0.1m from the EUT, with the Discharge Electrode touching the coupling plane.

The four faces of the EUT will be performed with electrostatic discharge.

- b. Air discharges at insulation surfaces of the EUT.

It was at least ten single discharges with positive and negative at the same selected point.

5.3.4 DEVIATION FROM TEST STANDARD

No deviation

5.3.5 TEST SETUP

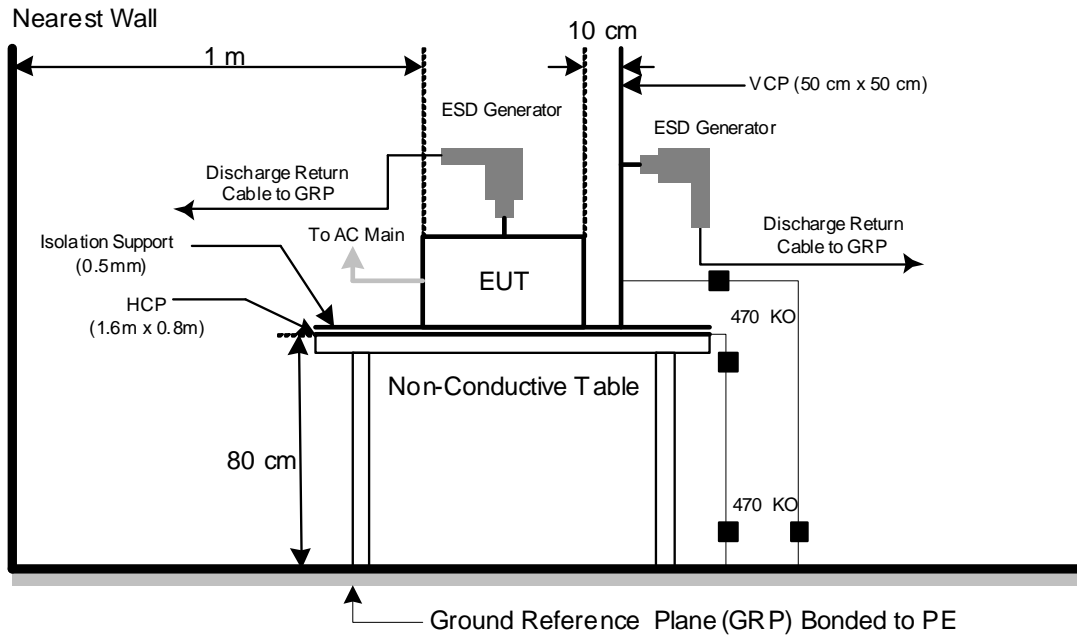

Note:

TABLE-TOP EQUIPMENT

The configuration consisted of a wooden table 0.8 meters high standing on the Ground Reference Plane. The GRP consisted of a sheet of aluminum at least 0.25mm thick, and 2.5 meters square connected to the protective grounding system. A Horizontal Coupling Plane (1.6m x 0.8m) was placed on the table and attached to the GRP by means of a cable with 940k total impedance. The equipment under test was installed in a representative system as described in EN 61000-4-2, and its cables were placed on the HCP and isolated by an insulating support of 0.5mm thickness. A distance of 1-meter minimum was provided between the EUT and the walls of the laboratory and any other metallic structure.

FLOOR-STANDING EQUIPMENT

The equipment under test was installed in a representative system as described in EN 61000-4-2, and its cables were isolated from the Ground Reference Plane by an insulating support of 0.1-meter thickness. The GRP consisted of a sheet of aluminum that is at least 0.25mm thick, and 2.5meters square connected to the protective grounding system and extended at least 0.5 meters from the EUT on all sides.

5.3.6 TEST RESULTS

EUT	IP Phone	Model Name	X5S
Temperature	25°C	Relative Humidity	46%
Test Voltage	AC 230V/50Hz	Pressure	1010hPa
Test Mode	Handfree,Handset,Headphone		

Mode	Air Discharge								Contact Discharge					
	2kV		4kV		8kV		- kV		2kV		4kV		- kV	
Location	P	N	P	N	P	N	P	N	P	N	P	N	P	N
1	A	A	A	A	A	A	-	-	A	A	A	A	-	-
2	A	A	A	A	B	B	-	-	-	-	-	-	-	-
3	A	A	A	A	A	A	-	-	-	-	-	-	-	-
4	A	A	A	A	A	A	-	-	-	-	-	-	-	-
5	A	A	A	A	A	A	-	-	-	-	-	-	-	-
6	A	A	A	A	A	A	-	-	-	-	-	-	-	-
7	A	A	A	A	A	A	-	-	-	-	-	-	-	-
8	A	A	A	A	A	A	-	-	-	-	-	-	-	-
Criteria	B						-		B					
Result	B						-		A					
Judgment	PASS						-		PASS					

Mode	HCP Contact Discharge						VCP Contact Discharge							
	2kV		4kV		- kV		2kV		4kV		- kV			
Location	P	N	P	N	P	N	P	N	P	N	P	N		
1	A	A	A	A	-	-	A	A	A	A	-	-		
2	A	A	A	A	-	-	A	A	A	A	-	-		
3	A	A	A	A	-	-	A	A	A	A	-	-		
4	A	A	A	A	-	-	A	A	A	A	-	-		
Criteria	B						-		B					
Result	A						-		A					
Judgment	PASS						-		PASS					

Note:

- 1) P/N denotes the Positive/Negative polarity of the output voltage.
- 2) Test condition:
 Direct/Indirect(HCP/VCP) discharges: Minimum 50 times (Positive/Negative) at eachpoint.
 Air discharges: Minimum 20 times (Positive/Negative) at each point.
- 3) Test location(s) in which discharge (Air and contact discharge) to be applied illustrated by photos shown in next page(s)
- 4) The Indirect (HCP/VCP) discharges description of test point as following:
 1.left side; 2.right side; 3.front side; 4.rear side.
- 5) N/A - denotes test is not applicable in this test report
- 6) Criterion A: No observation of any performance degradation.
- 7) Criterion B: Some degradation of performance is observed but the equipment continues to operate as intended.
- 8) Criterion C: Loss of functionality, but self-recoverable by user, without loss of information or settings.

PHOTO(S) SHOWN THE LOCATION(S) OF ESD EVALUATED

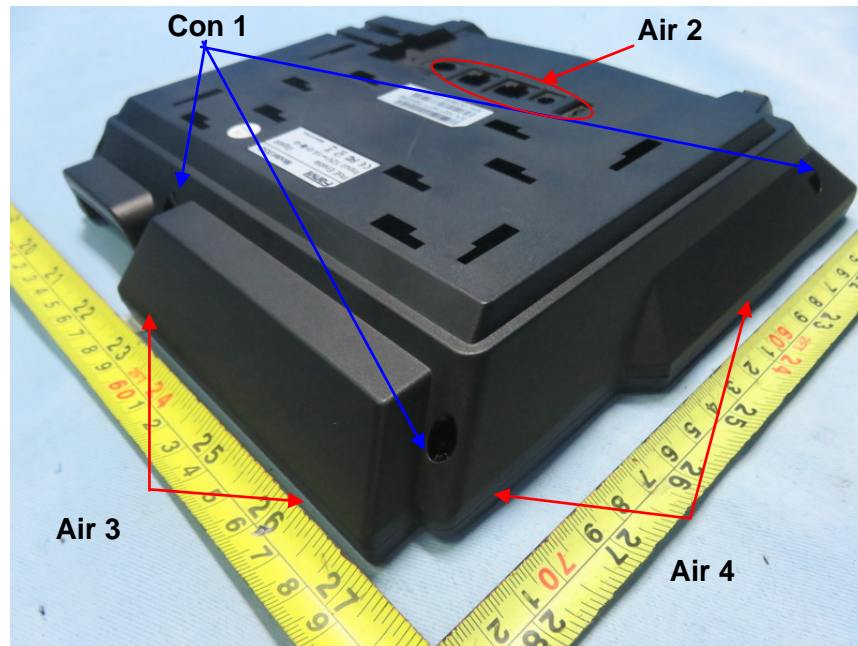
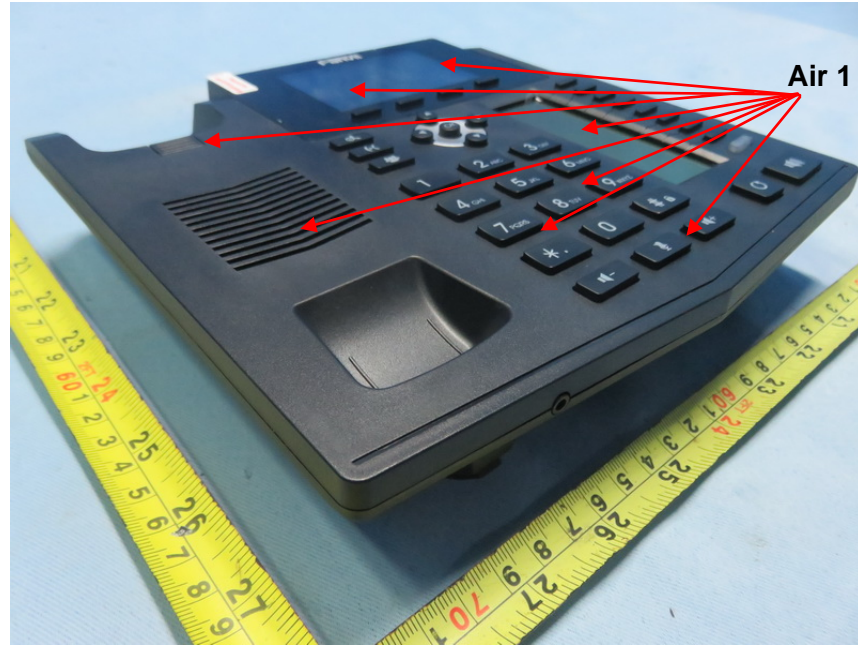

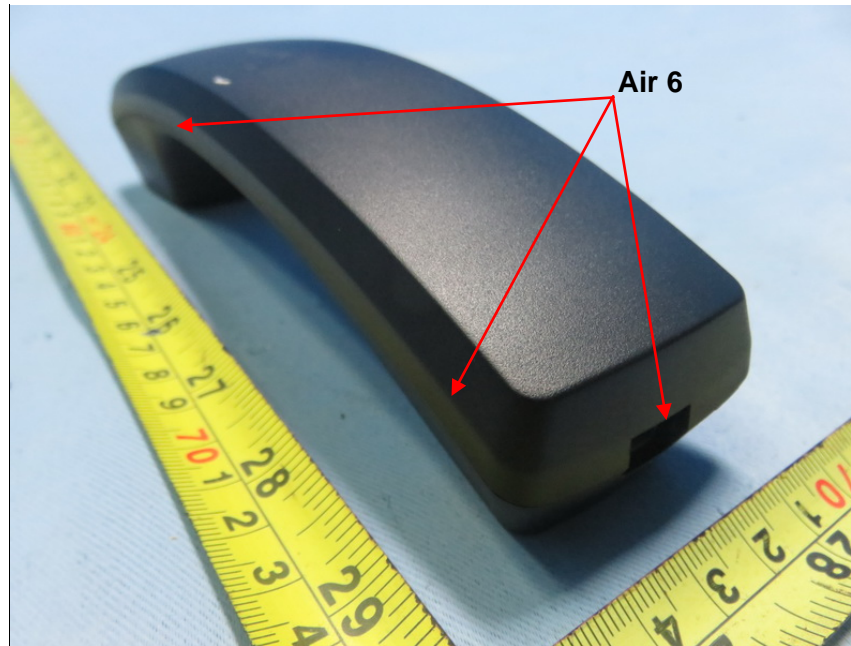
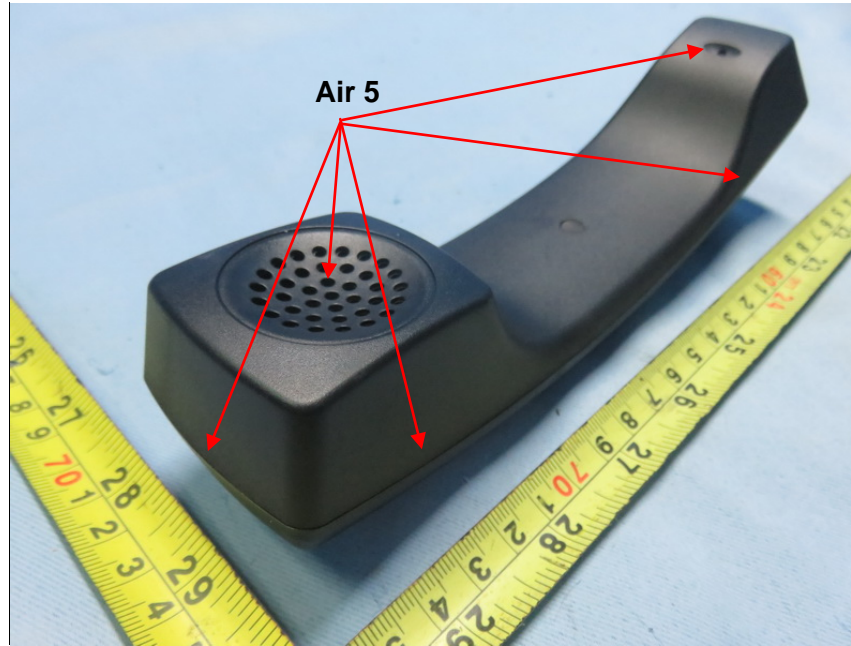

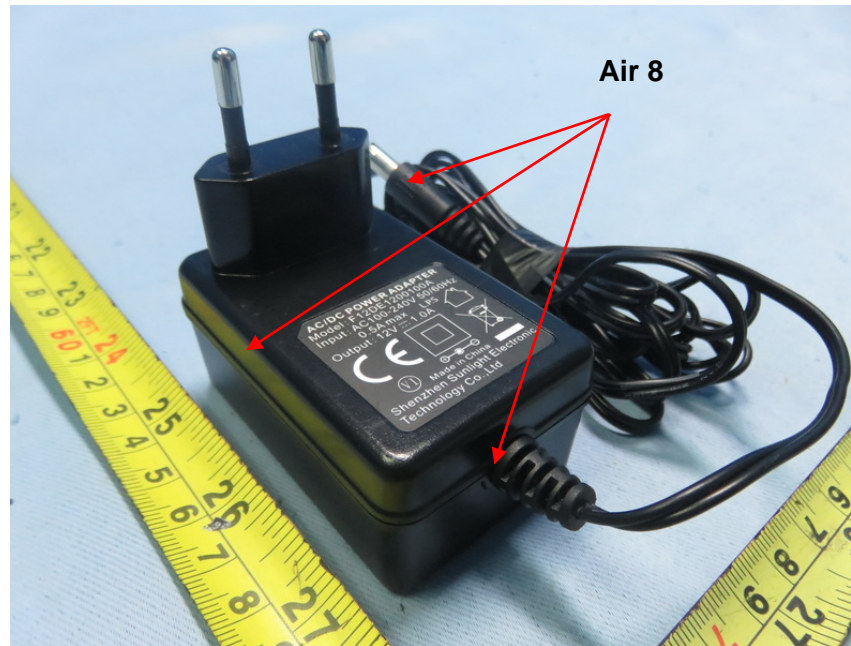
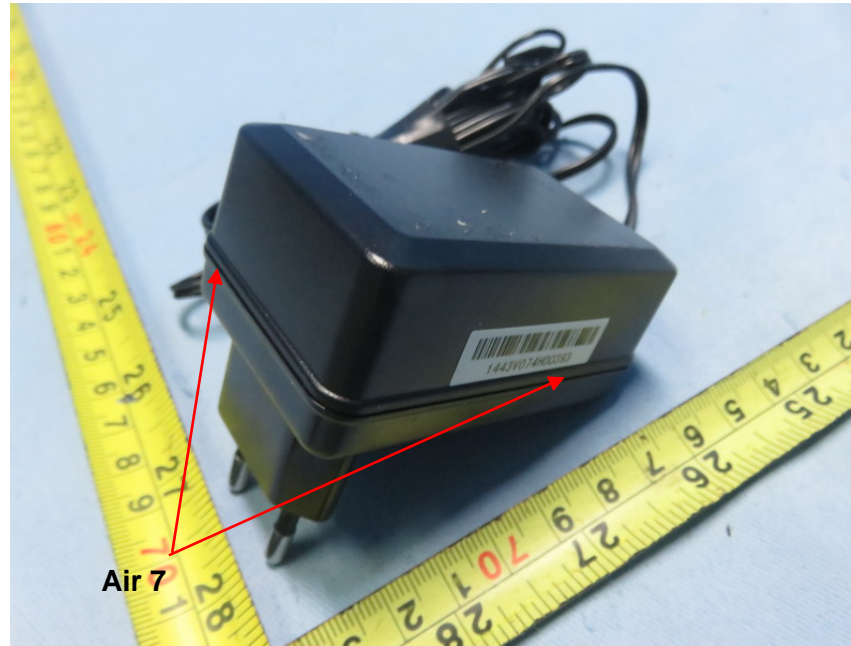

5.4 RADIATED, RADIO-FREQUENCY, ELECTROMAGNETIC FIELD IMMUNITY TEST (RS)

5.4.1 TEST SPECIFICATION

Basic Standard	EN 61000-4-3
Required Performance	A
Frequency Range	80 MHz - 1000 MHz
Field Strength	3 V/m(unmodulated, r.m.s)
Modulation	1 kHz Sine Wave, 80%, AM Modulation
Frequency Step	1% of fundamental
Polarity of Antenna	Horizontal and Vertical
Test Distance	3 m
Antenna Height	1.5 m
Dwell Time	at least 3 seconds

5.4.2 MEASUREMENT INSTRUMENTS

Item	Kind of Equipment	Manufacturer	Type No.	Serial No.	Calibrated until
1	Audio Test System	Audio precision	ATS-1ACC ESS	ATS1-45376	Mar. 26, 2018
2	Conditioning Amplifier	B&K	_2690__0F 2_	2723746	Jul. 03, 2018
3	Antenna	ETS	3142C	00047662	Mar. 26, 2018
4	Digital Signal Generator	HP	ESG-D300 0A	US36260188	Mar. 26, 2018
5	Power amplifier	MILMEGA	80RF1000- 250	1064833	Nov. 02, 2017
6	Measurement Software	TOYO	IM5/RS Ver 3.8.050	N/A	N/A

Remark: "N/A" denotes no model name, no serial No. or no calibration specified.

All calibration period of equipment list is one year.

5.4.3 TEST PROCEDURE

The EUT and support equipment, which are placed on a table that is 0.8 meter above ground and the testing was performed in a fully-anechoic chamber.

The testing distance from antenna to the EUT was 3 meters.

The other condition as following manner:

- a. The field strength level was 3 V/m(unmodulated, r.m.s).
- b. The frequency range is swept from 80 MHz to 1000 MHz, with the signal 80%amplitude modulated with a 1 kHz sine wave. The rate of sweep did not exceed 1.5×10^{-3} decade/s. Where the frequency range is swept incrementally, the step size was 1% of fundamental.
- c. The dwell time at each frequency shall be not less than the time necessary for the EUT to be able to respond.
- d. The test was performed with the EUT exposed to both vertically and horizontally polarized fields on each of the four sides.

5.4.4 DEVIATION FROM TEST STANDARD

No deviation

5.4.5 TEST SETUP

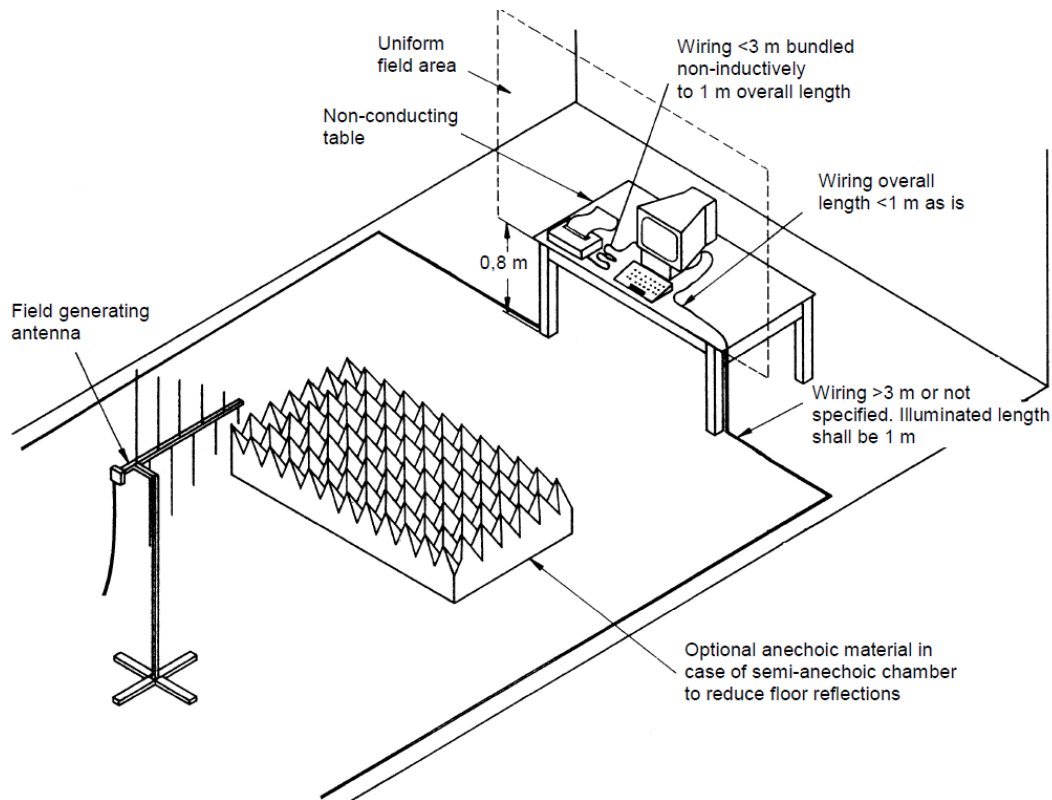

Note:

TABLE-TOP EQUIPMENT

The EUT installed in a representative system as described in EN 61000-4-3 was placed on a non-conductive table 0.8 meters in height. The system under test was connected to the power and signal wire according to relevant installation instructions.

FLOOR-STANDING EQUIPMENT

The EUT installed in a representative system as described in EN 61000-4-3 was placed on a non-conductive wood support 0.1 meters in height. The system under test was connected to the power and signal wire according to relevant installation instructions.

5.4.6 TEST RESULTS

EUT	IP Phone	Model Name	X5S
Temperature	25°C	Relative Humidity	54%
Test Voltage	AC 230V/50Hz		
Test Mode	Handfree,Handset,Headphone		

Frequency Range (MHz)	RF Field Position	R.F. Field Strength	Azimuth	Criterion	Result	Judgment
80 - 1000	H / V	3V (unmodulated, r.m.s) AM Modulated 1000Hz, 80%	0	A	A	PASS
			90			
			180			
			270			

Note:

- 1) P/N denotes the Positive/Negative polarity of the output voltage.
- 2) N/A - denotes test is not applicable in this test report.
- 3) Criterion A: No observation of any performance degradation.
- 4) Criterion B: Some degradation of performance is observed but the equipment continues to operate as intended.
- 5) Criterion C: Loss of functionality, but self-recoverable by user, without loss of information or settings.

EUT	IP Phone	Model Name	X5S
Temperature	25°C	Relative Humidity	50%
Test Voltage	AC 230V/50Hz	Polarization	Vertical
Test Mode	Handset		
Note	Adapter Left		

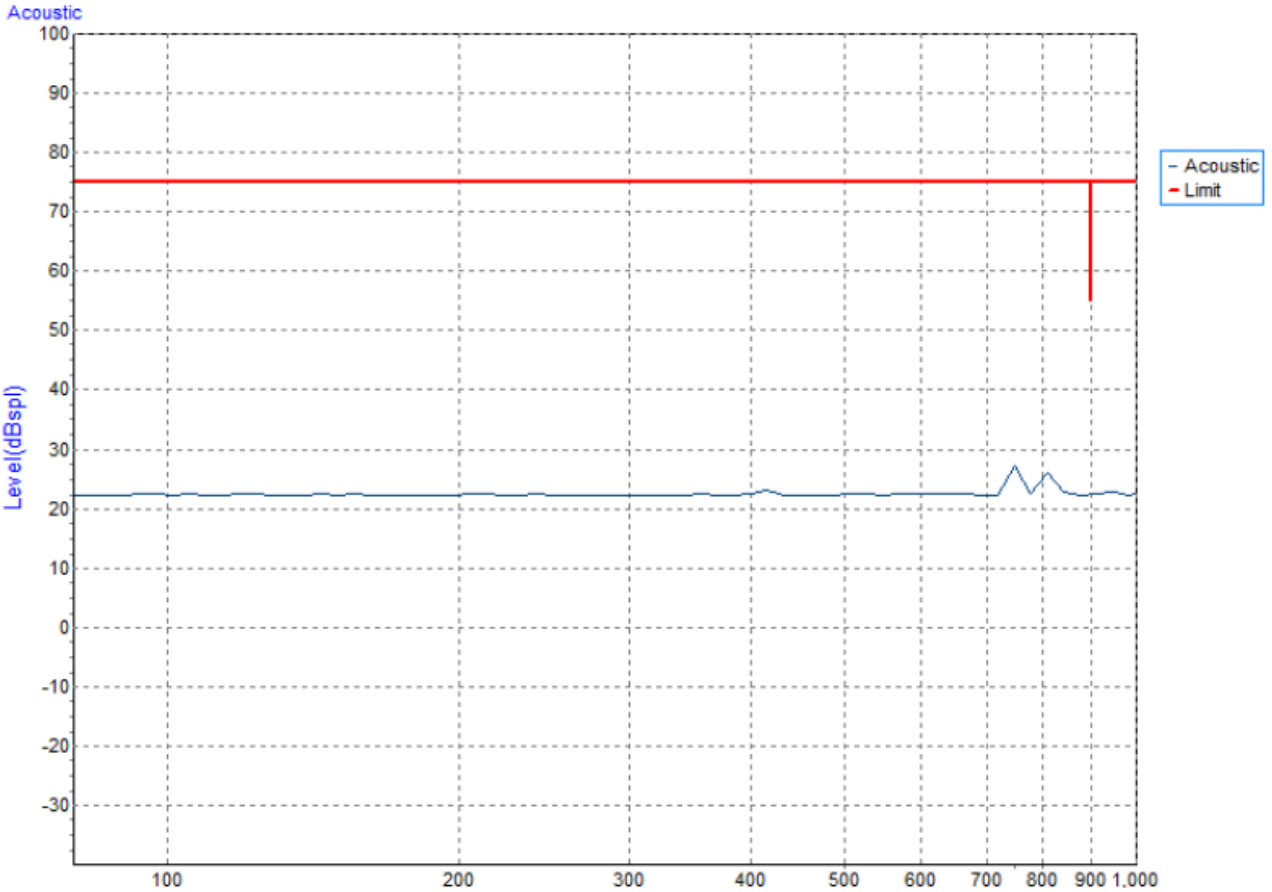

EUT	IP Phone	Model Name	X5S
Temperature	25°C	Relative Humidity	50%
Test Voltage	AC 230V/50Hz	Polarization	Horizontal
Test Mode	Handset		
Note	Adapter Left		

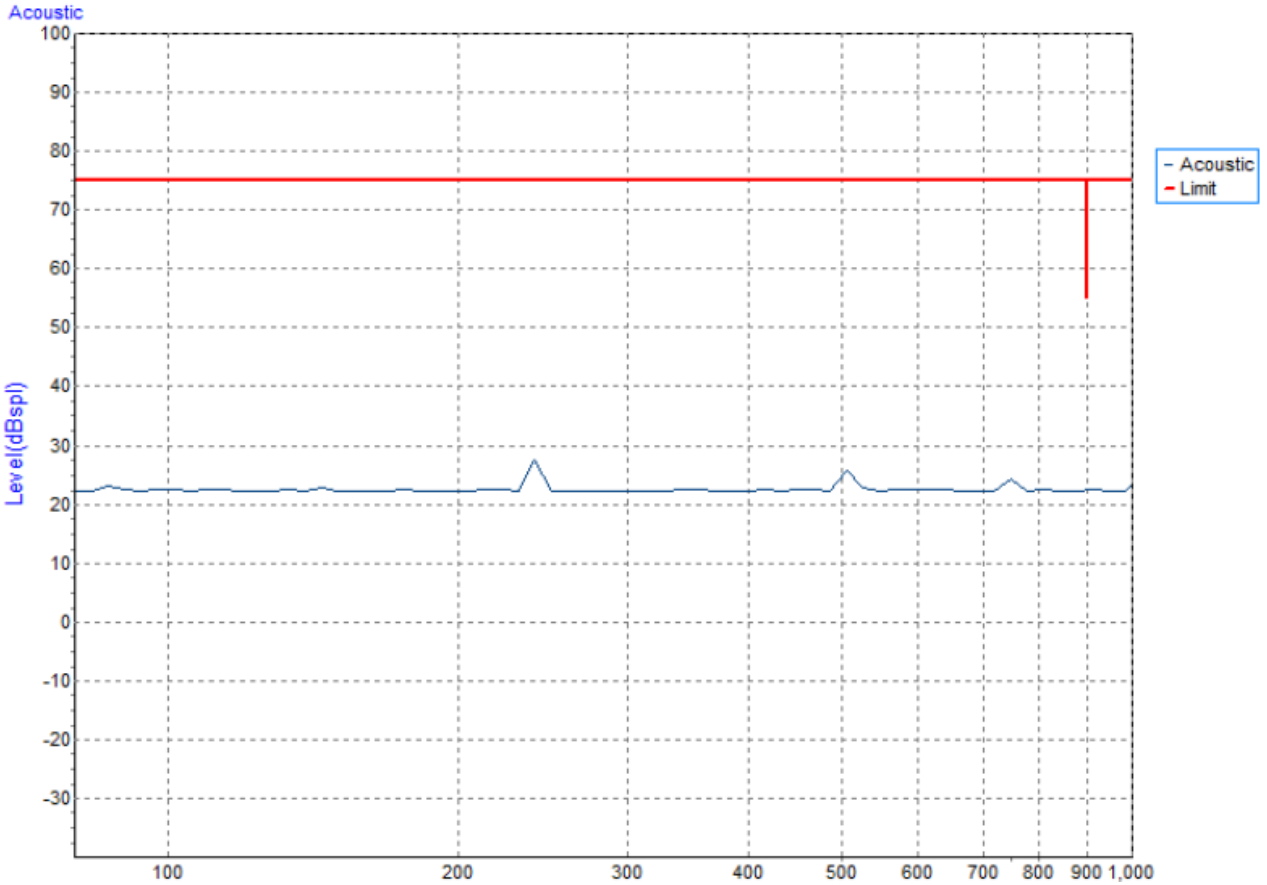

EUT	IP Phone	Model Name	X5S
Temperature	25°C	Relative Humidity	50%
Test Voltage	AC 230V/50Hz	Polarization	Vertical
Test Mode	Handset		
Note	Adapter Right		

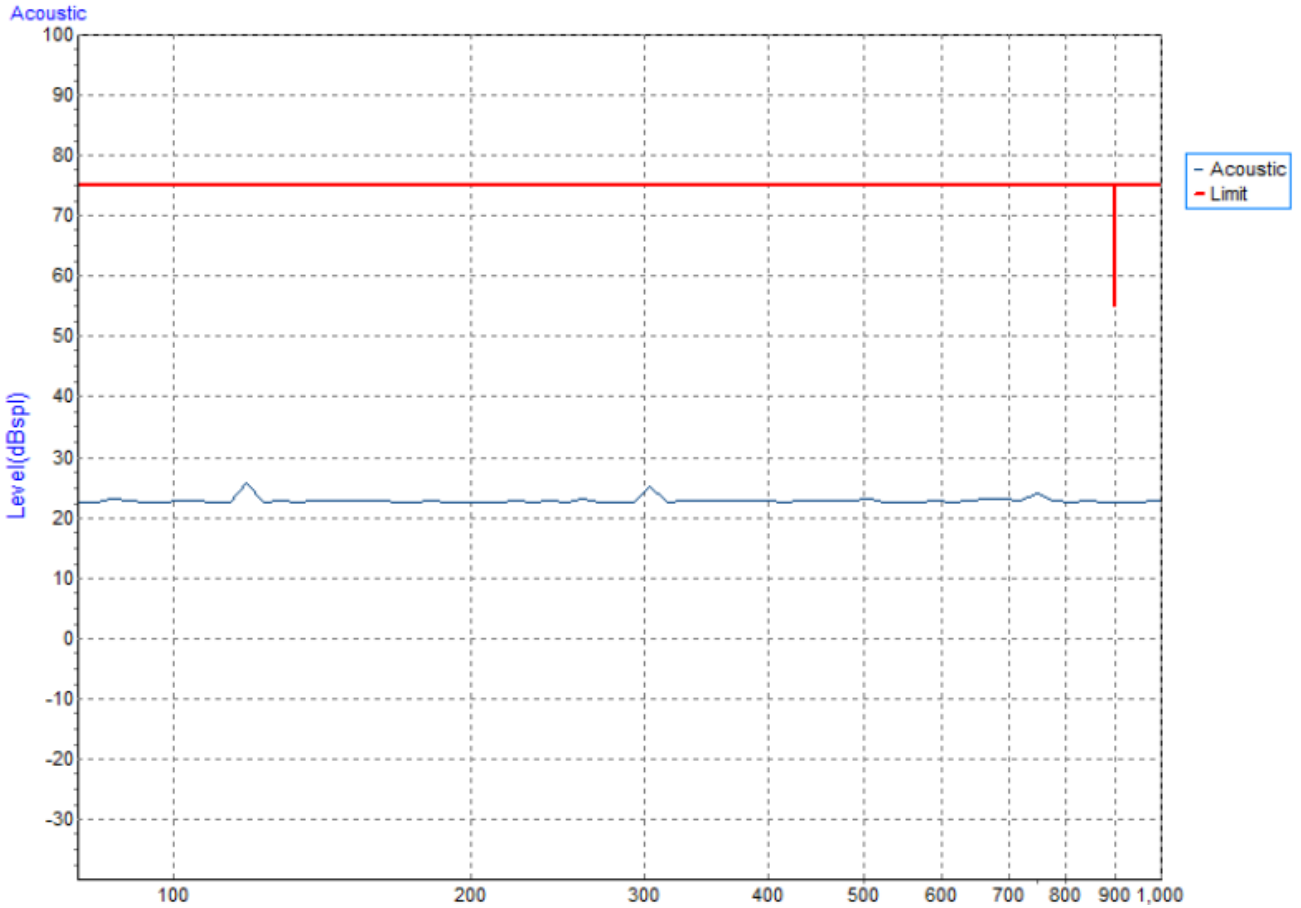

EUT	IP Phone	Model Name	X5S
Temperature	25°C	Relative Humidity	50%
Test Voltage	AC 230V/50Hz	Polarization	Horizontal
Test Mode	Handset		
Note	Adapter Right		

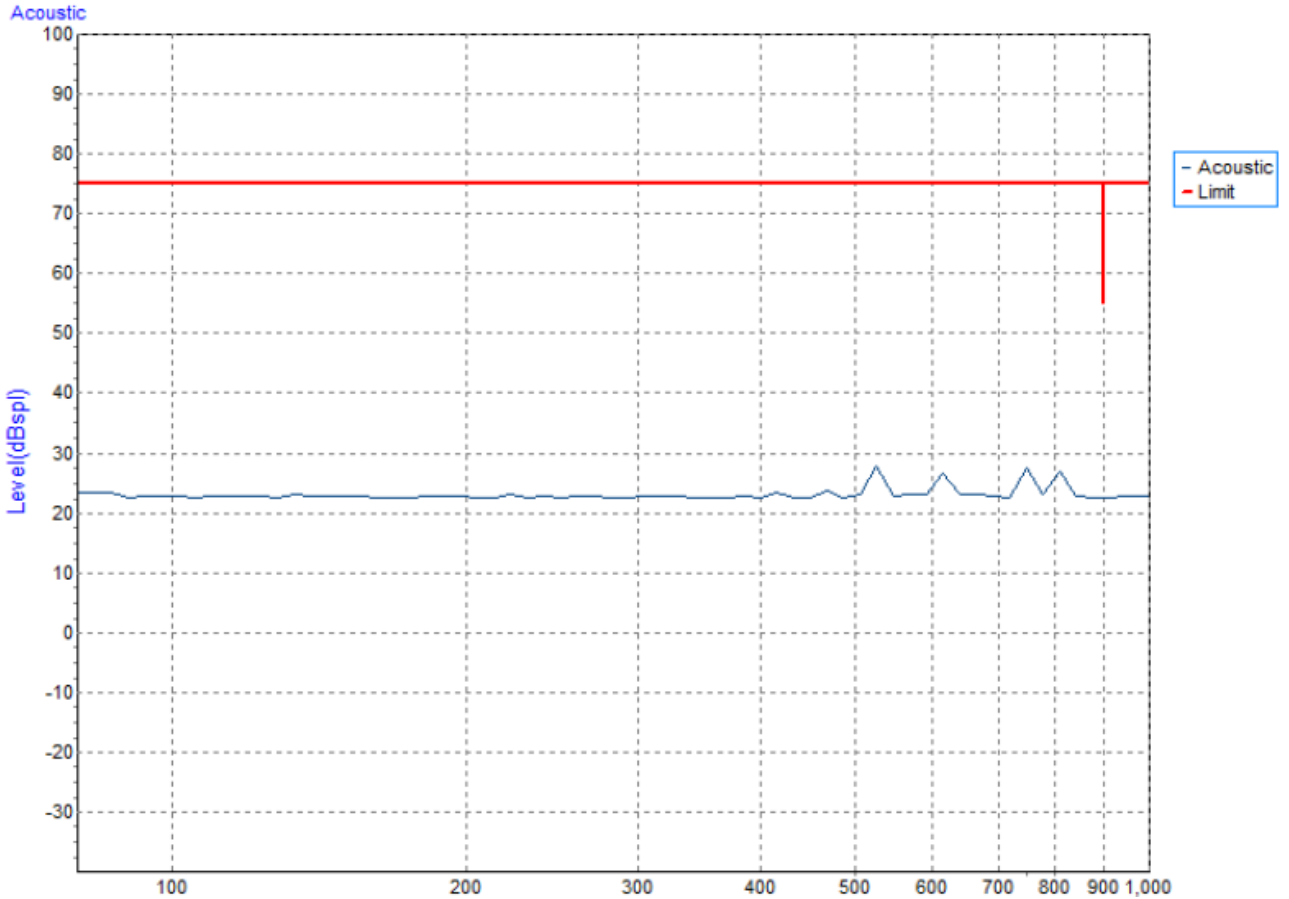

EUT	IP Phone	Model Name	X5S
Temperature	25°C	Relative Humidity	50%
Test Voltage	AC 230V/50Hz	Polarization	Vertical
Test Mode	Handset		
Note	Adapter Front		

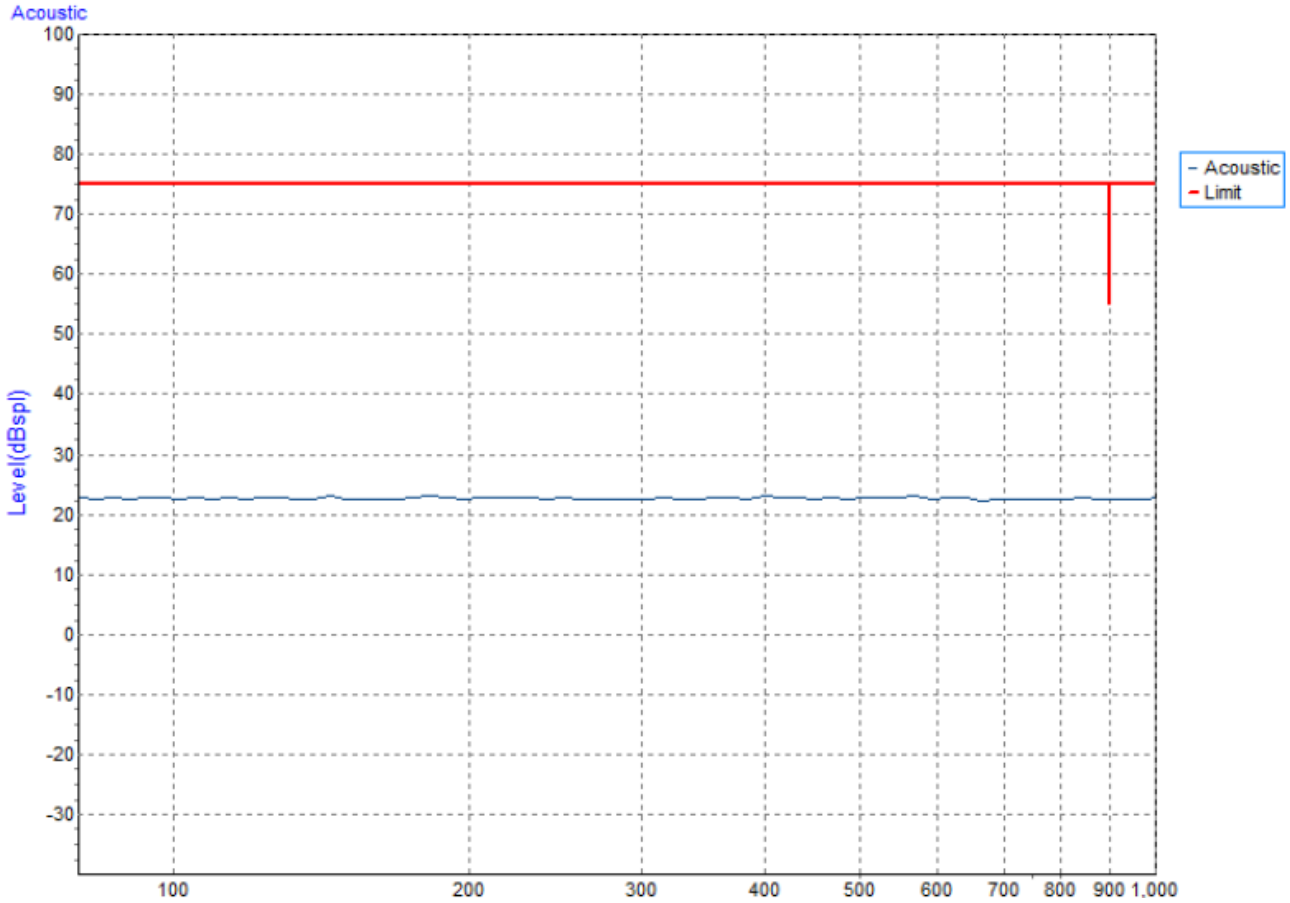

EUT	IP Phone	Model Name	X5S
Temperature	25°C	Relative Humidity	50%
Test Voltage	AC 230V/50Hz	Polarization	Horizontal
Test Mode	Handset		
Note	Adapter Front		

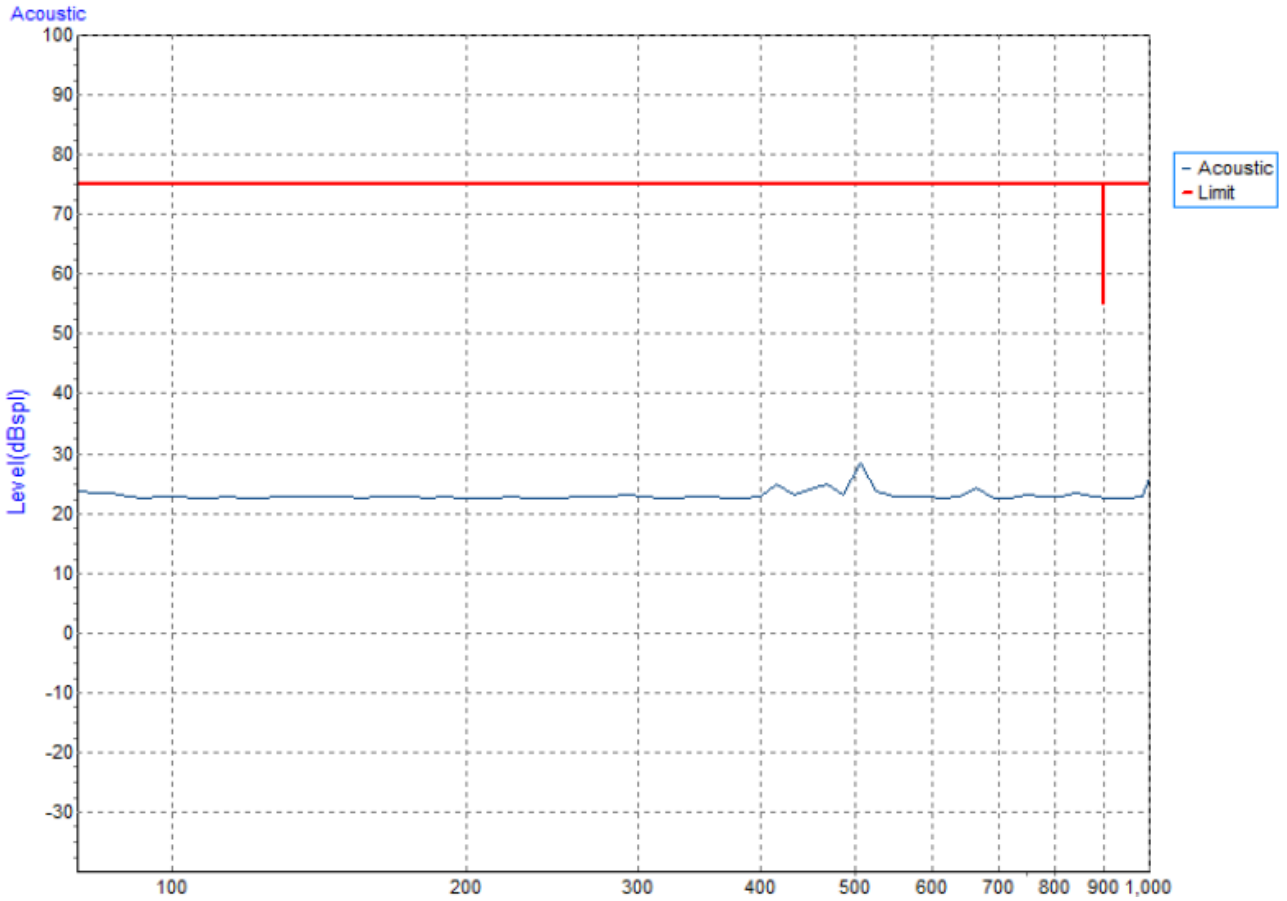

EUT	IP Phone	Model Name	X5S
Temperature	25°C	Relative Humidity	50%
Test Voltage	AC 230V/50Hz	Polarization	Vertical
Test Mode	Handset		
Note	Adapter Rear		

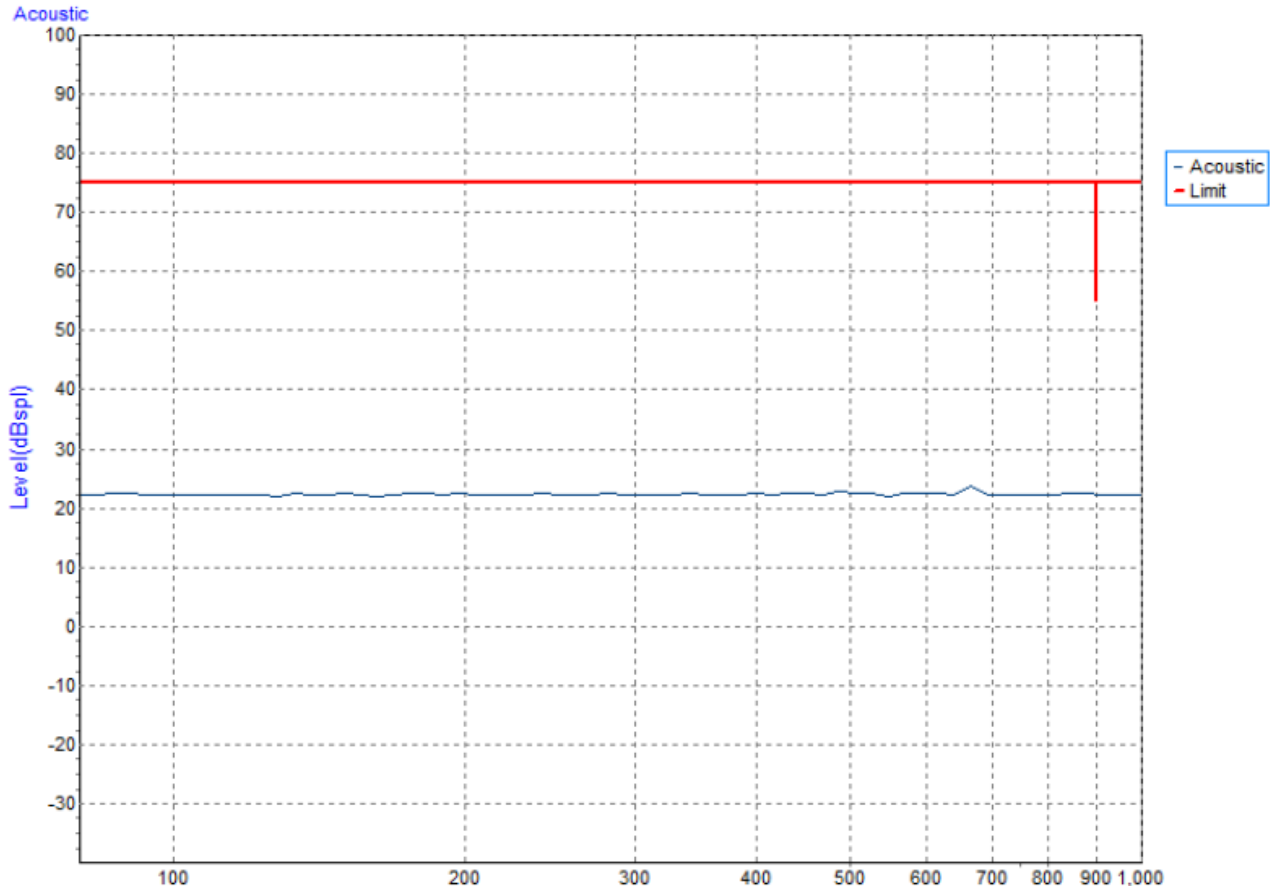

EUT	IP Phone	Model Name	X5S
Temperature	25°C	Relative Humidity	50%
Test Voltage	AC 230V/50Hz	Polarization	Horizontal
Test Mode	Handset		
Note	Adapter Rear		

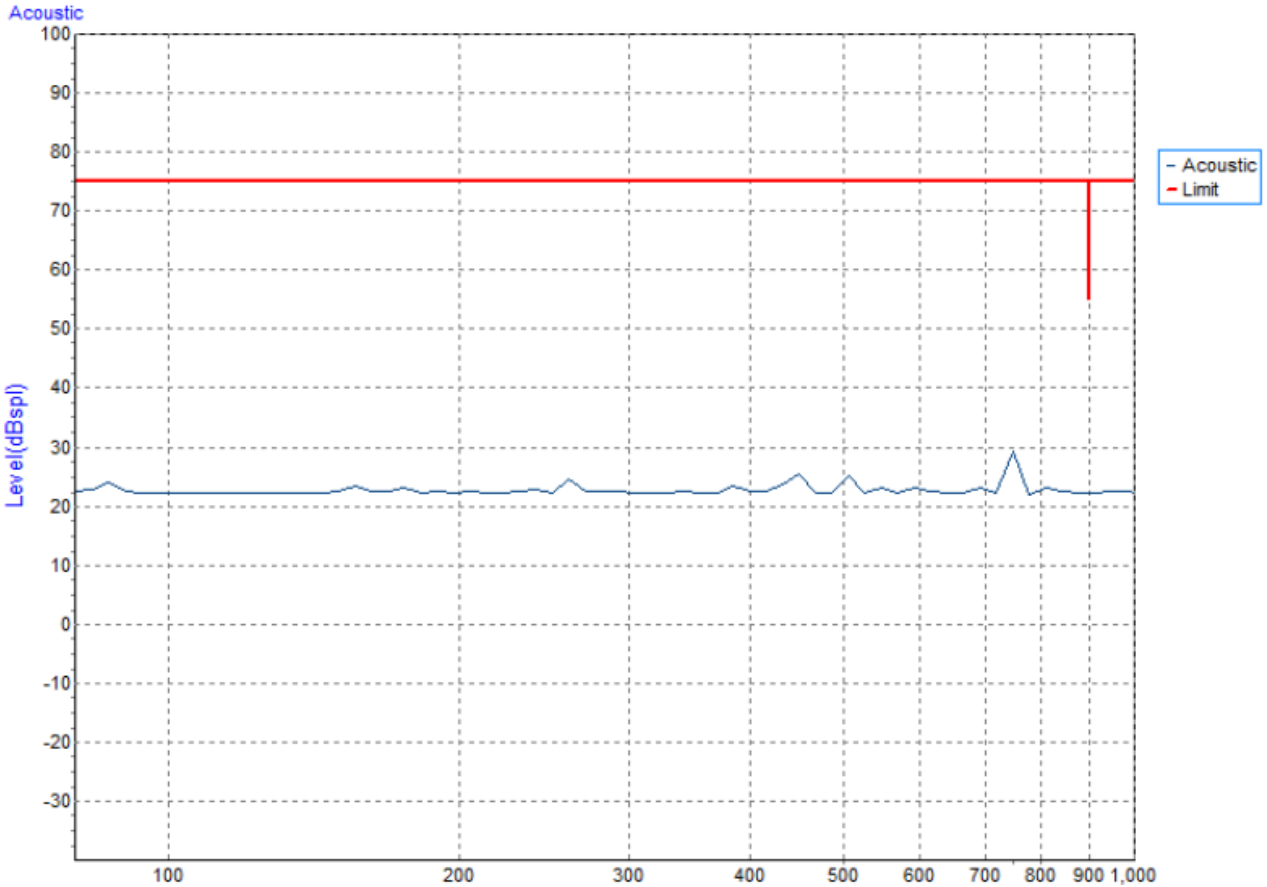

EUT	IP Phone	Model Name	X5S
Temperature	25°C	Relative Humidity	50%
Test Voltage	DC 48V	Polarization	Vertical
Test Mode	Handset		
Note	PoE Left		

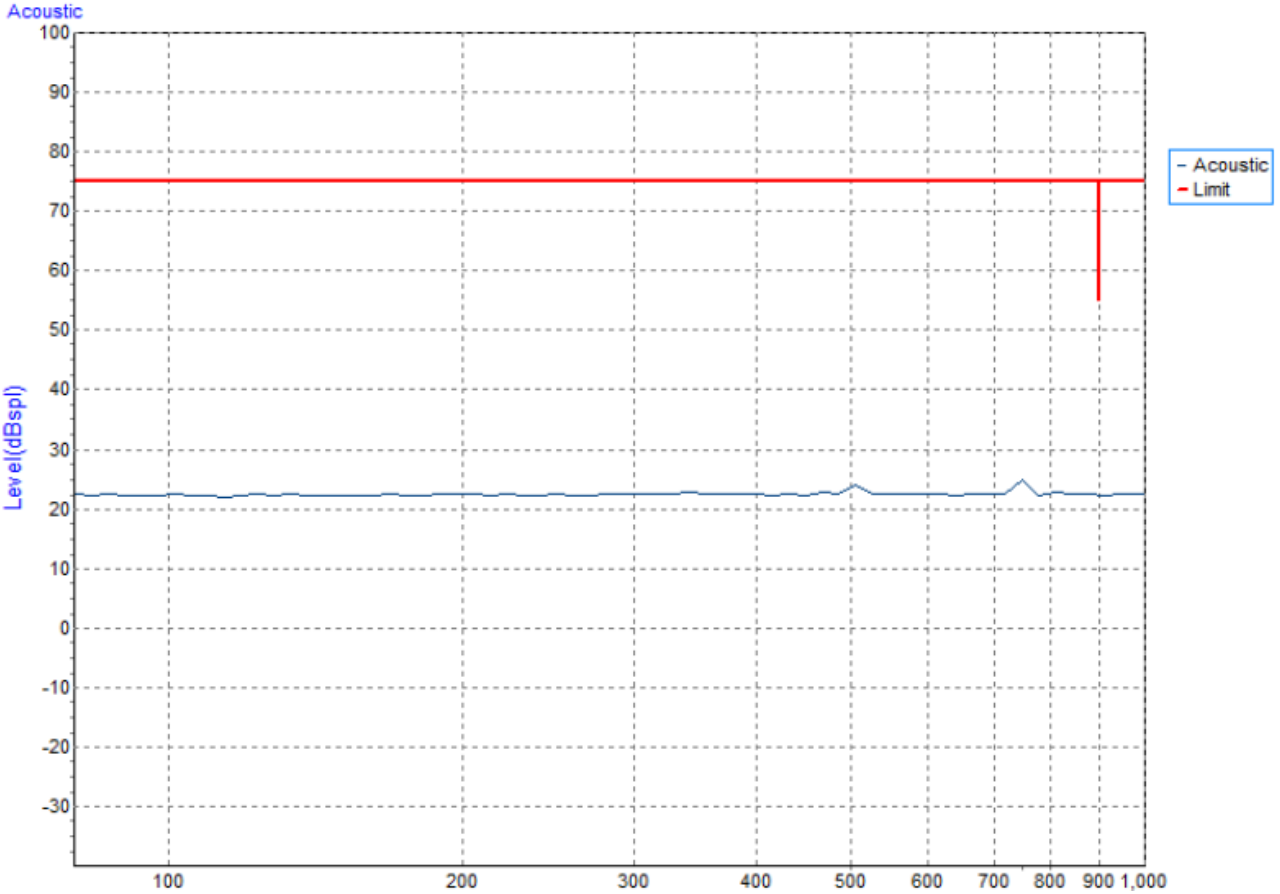

EUT	IP Phone	Model Name	X5S
Temperature	25°C	Relative Humidity	50%
Test Voltage	DC 48V	Polarization	Horizontal
Test Mode	Handset		
Note	PoE Left		

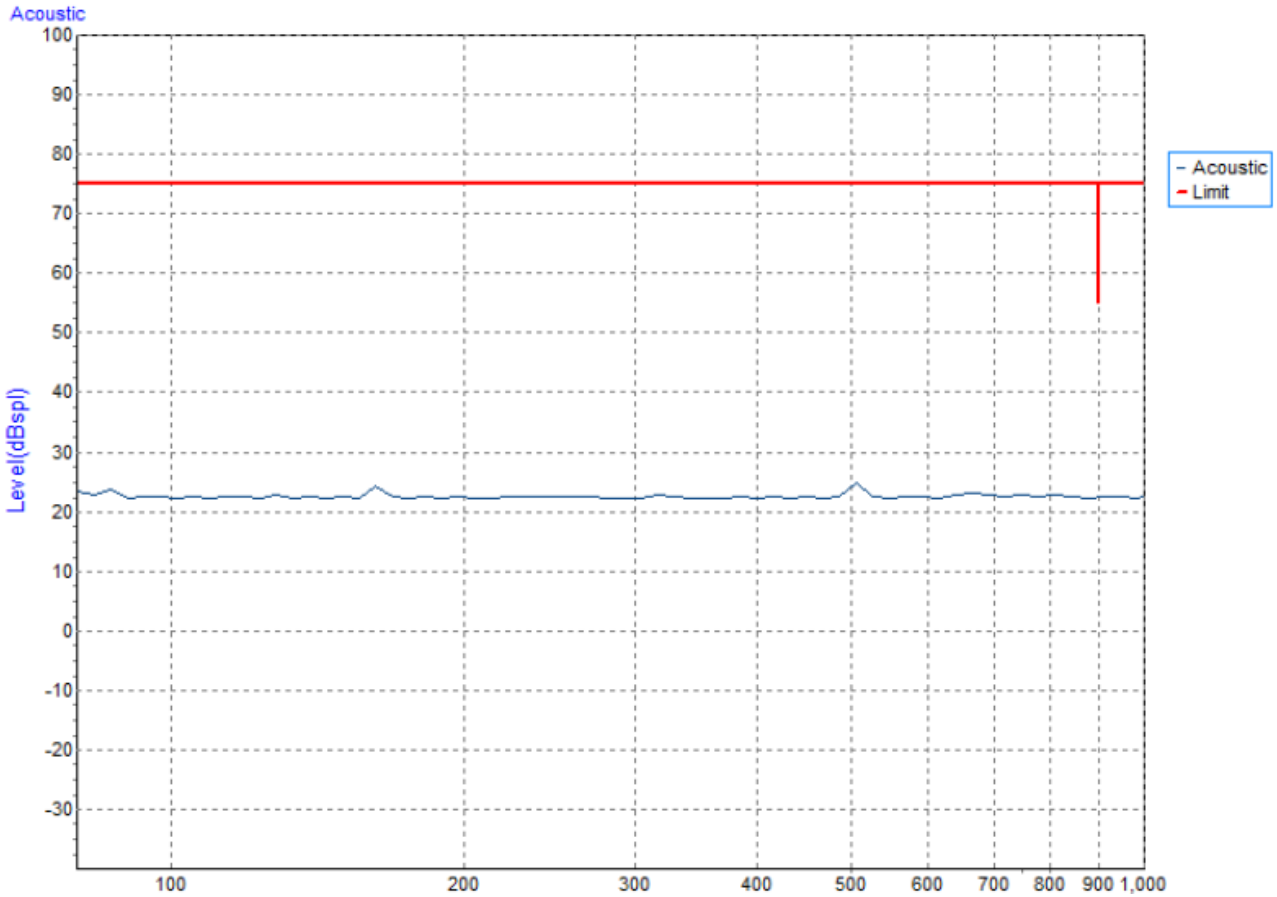

EUT	IP Phone	Model Name	X5S
Temperature	25°C	Relative Humidity	50%
Test Voltage	DC 48V	Polarization	Vertical
Test Mode	Handset		
Note	PoE Right		

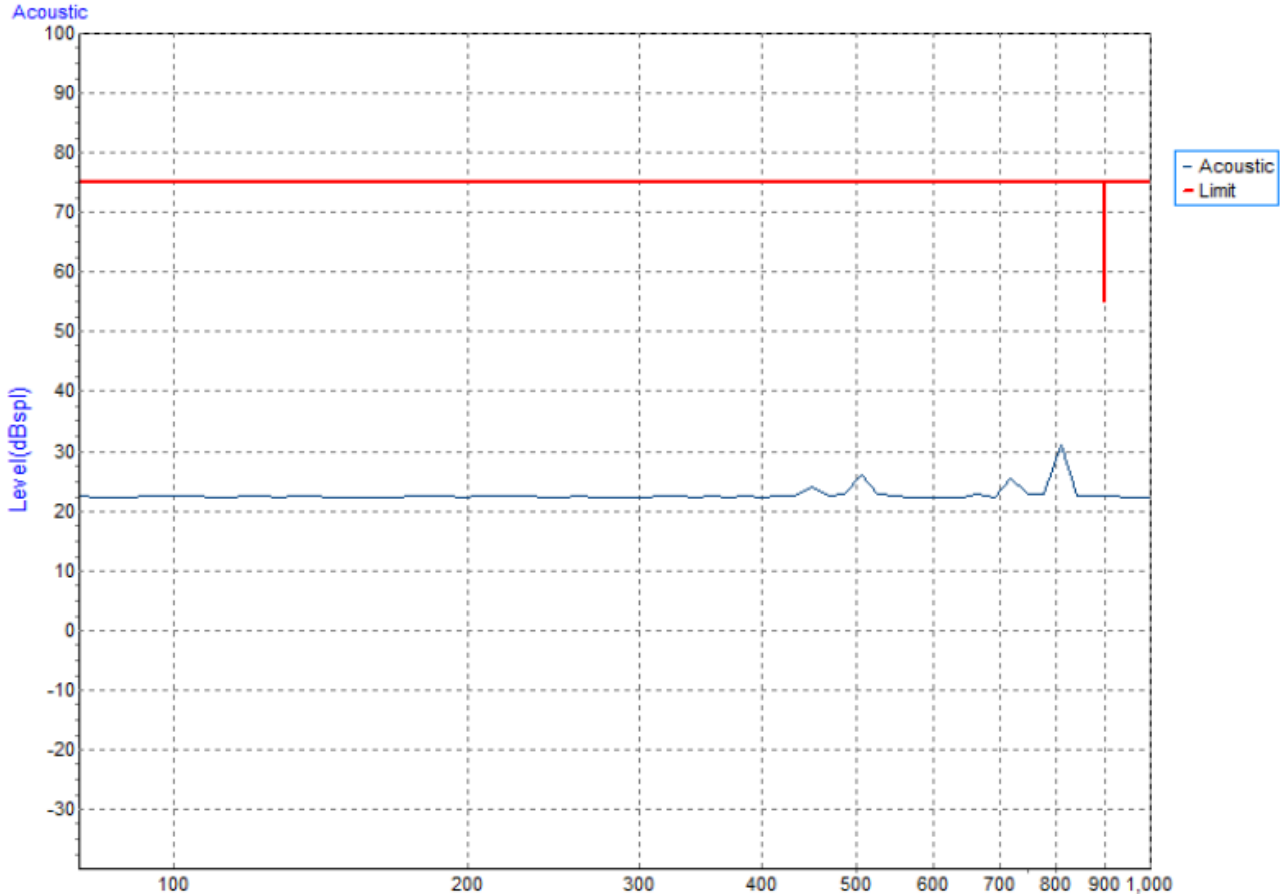

EUT	IP Phone	Model Name	X5S
Temperature	25°C	Relative Humidity	50%
Test Voltage	DC 48V	Polarization	Horizontal
Test Mode	Handset		
Note	PoE Right		

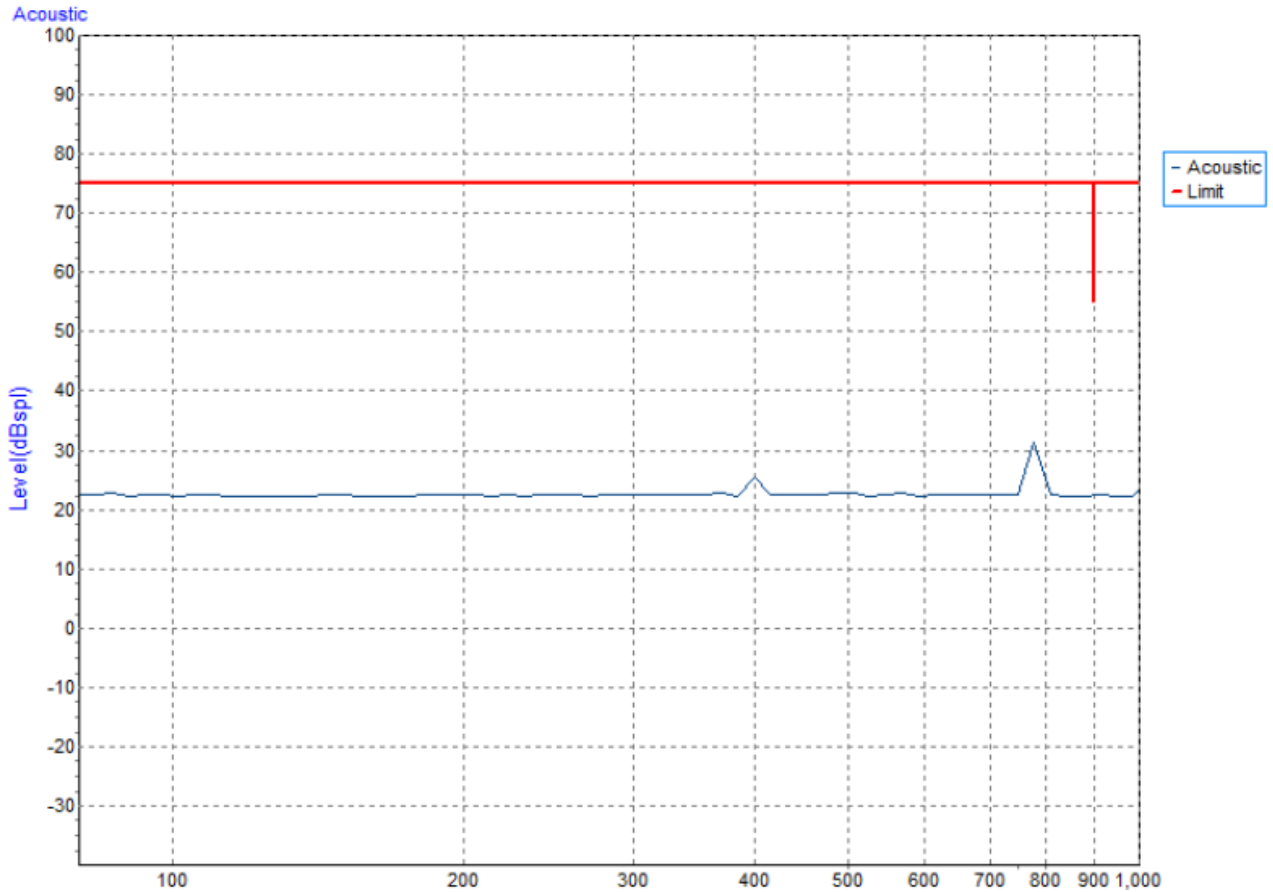

EUT	IP Phone	Model Name	X5S
Temperature	25°C	Relative Humidity	50%
Test Voltage	DC 48V	Polarization	Vertical
Test Mode	Handset		
Note	PoE Front		

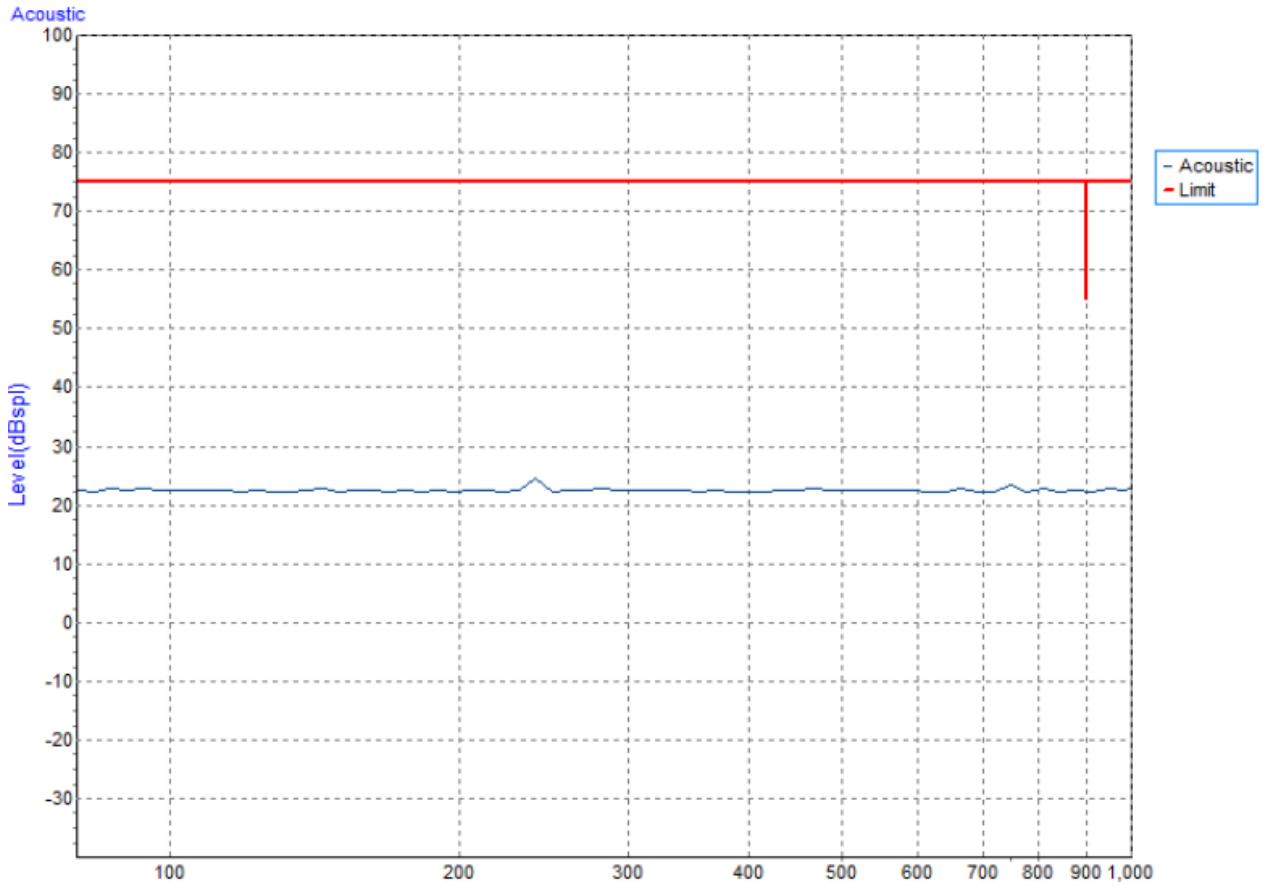

EUT	IP Phone	Model Name	X5S
Temperature	25°C	Relative Humidity	50%
Test Voltage	DC 48V	Polarization	Horizontal
Test Mode	Handset		
Note	PoE Front		

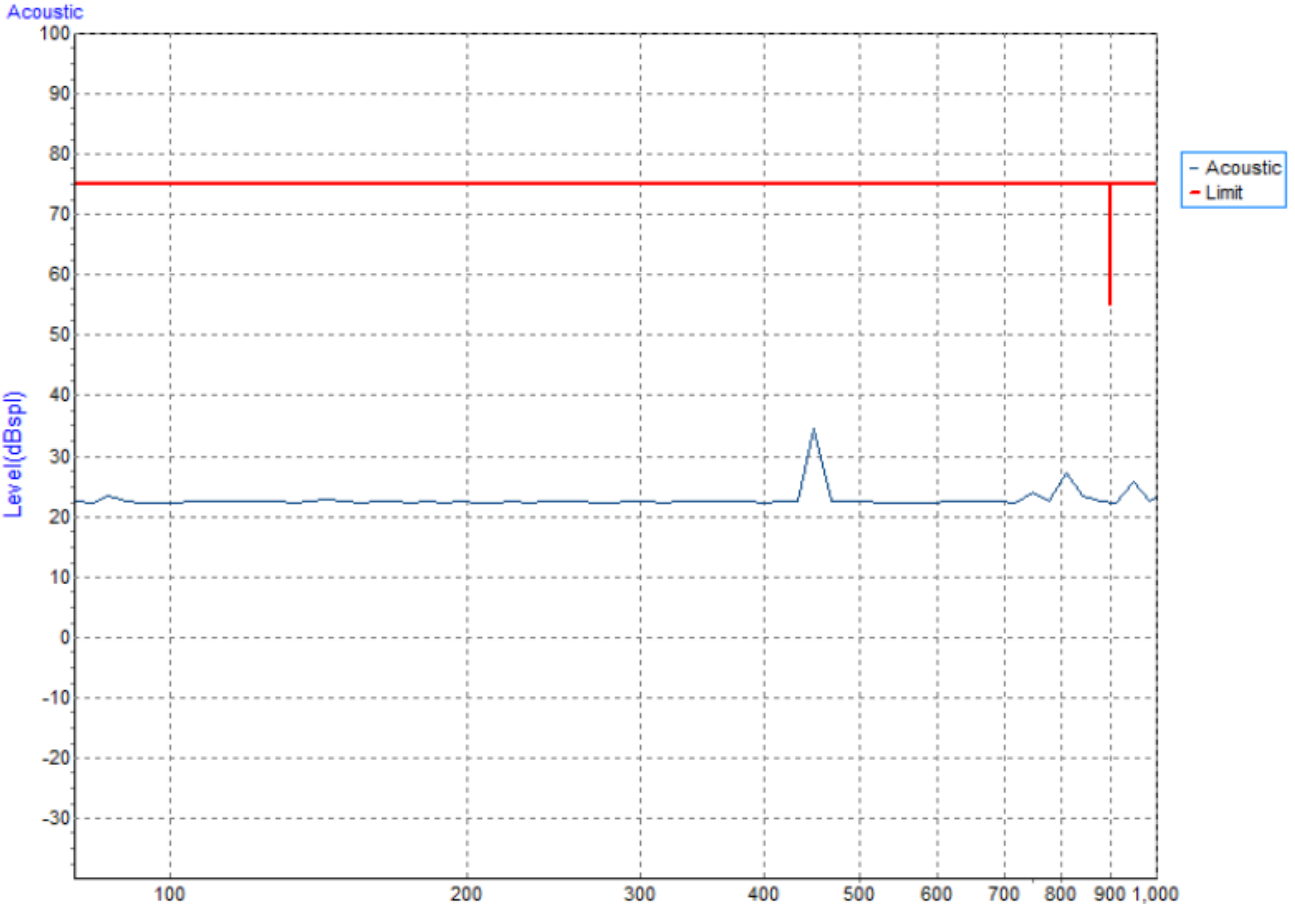

EUT	IP Phone	Model Name	X5S
Temperature	25°C	Relative Humidity	50%
Test Voltage	DC 48V	Polarization	Vertical
Test Mode	Handset		
Note	PoE Rear		

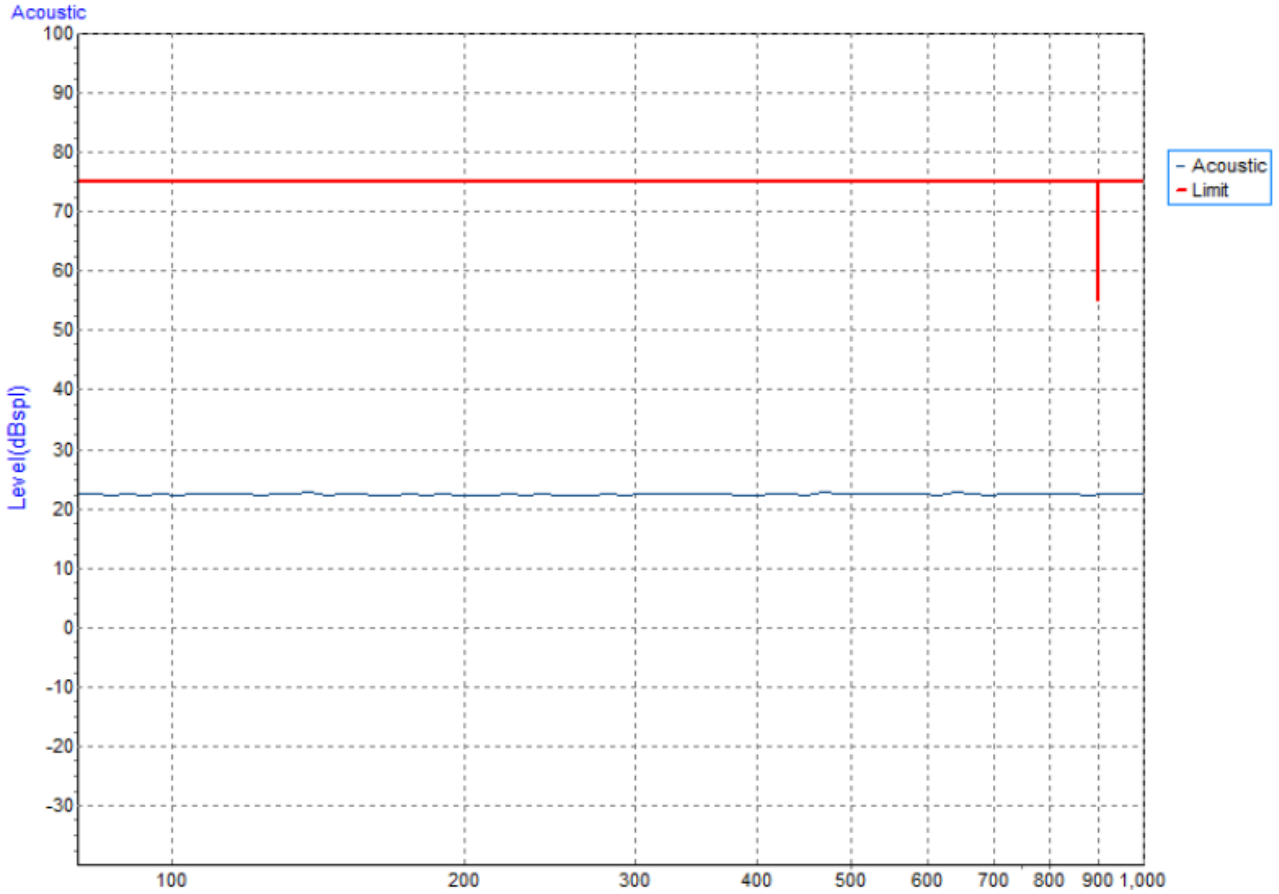

EUT	IP Phone	Model Name	X5S
Temperature	25°C	Relative Humidity	50%
Test Voltage	DC 48V	Polarization	Horizontal
Test Mode	Handset		
Note	PoE Rear		

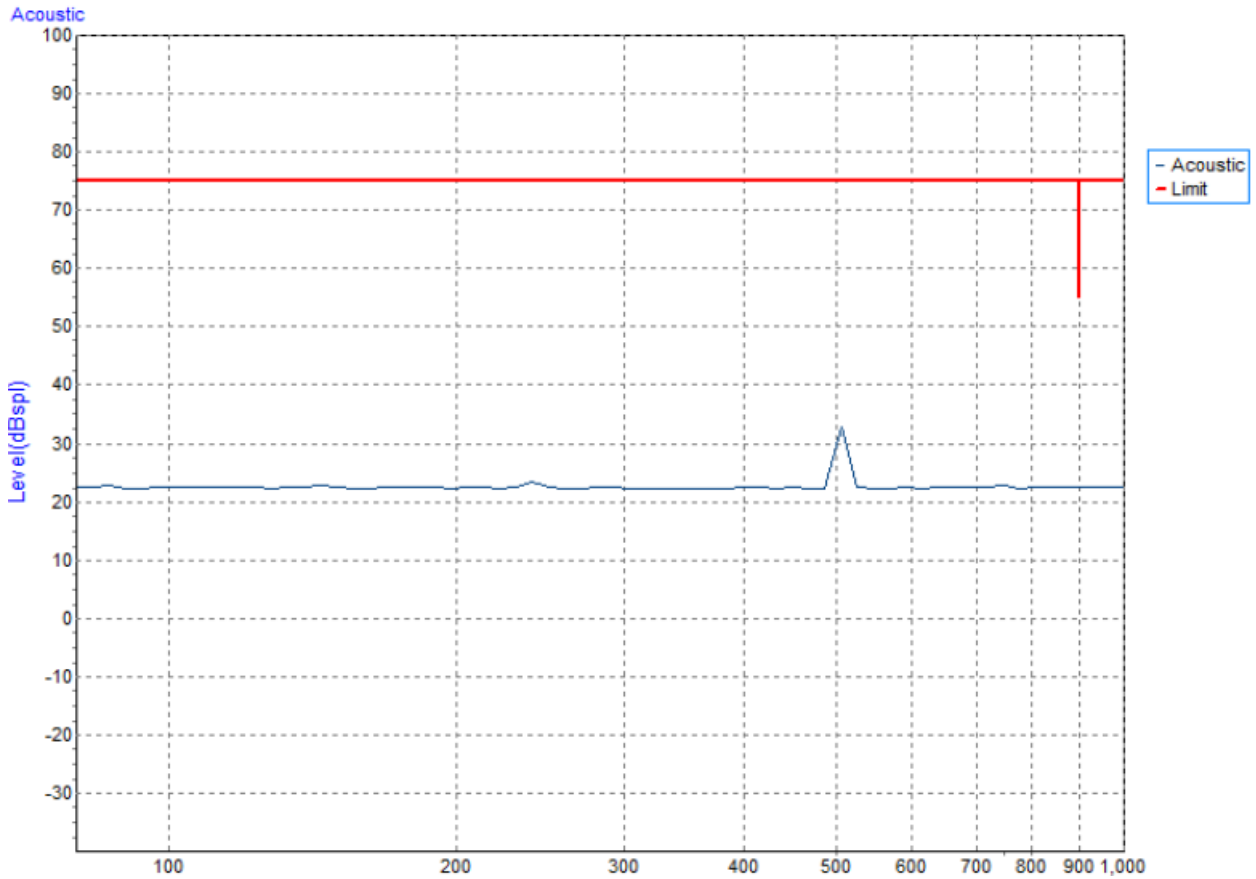

EUT	IP Phone	Model Name	X5S
Temperature	25°C	Relative Humidity	50%
Test Voltage	AC 230V/50Hz	Polarization	Vertical
Test Mode	Handfree		
Note	Adapter Left		

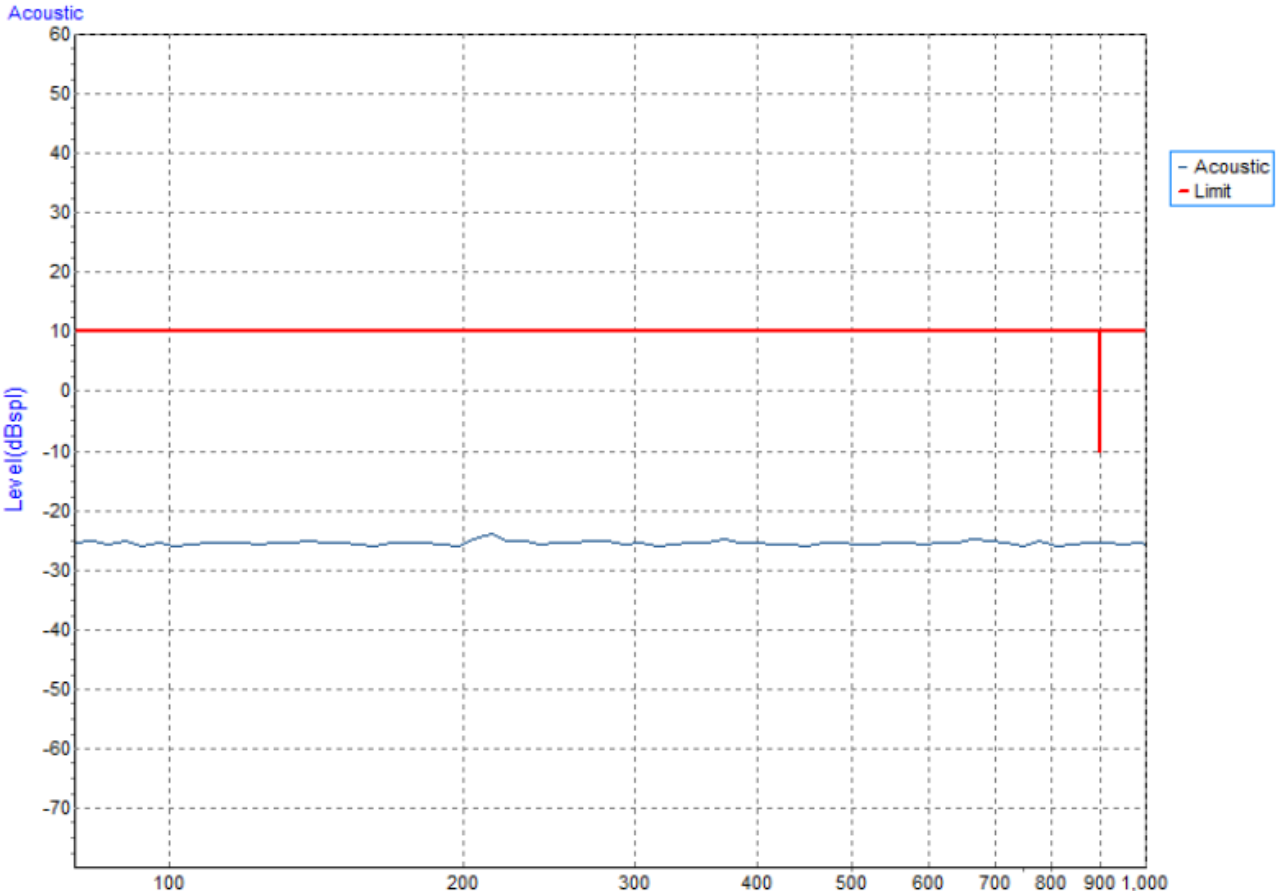

EUT	IP Phone	Model Name	X5S
Temperature	25°C	Relative Humidity	50%
Test Voltage	AC 230V/50Hz	Polarization	Horizontal
Test Mode	Handfree		
Note	Adapter Left		

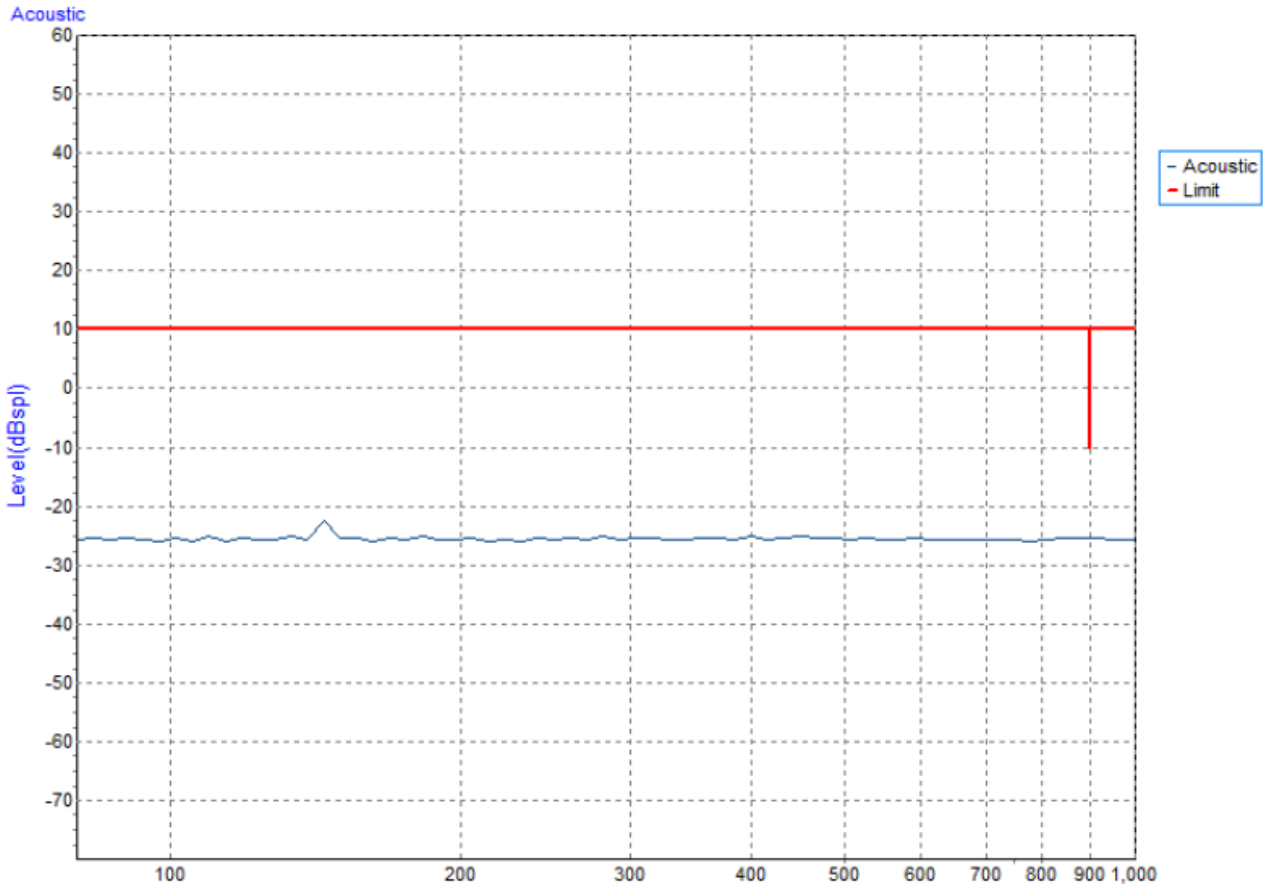

EUT	IP Phone	Model Name	X5S
Temperature	25°C	Relative Humidity	50%
Test Voltage	AC 230V/50Hz	Polarization	Vertical
Test Mode	Handfree		
Note	Adapter Right		

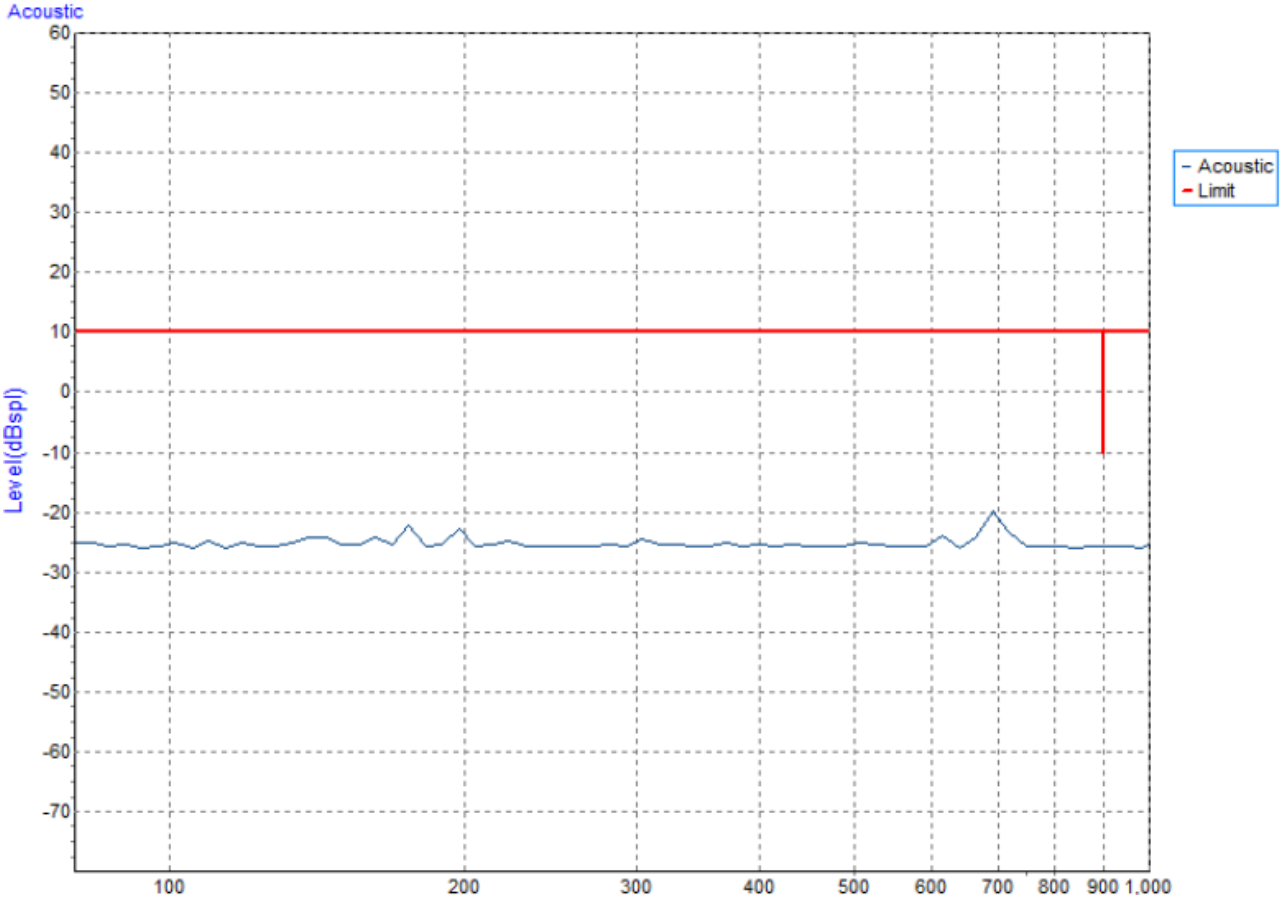

EUT	IP Phone	Model Name	X5S
Temperature	25°C	Relative Humidity	50%
Test Voltage	AC 230V/50Hz	Polarization	Horizontal
Test Mode	Handfree		
Note	Adapter Right		

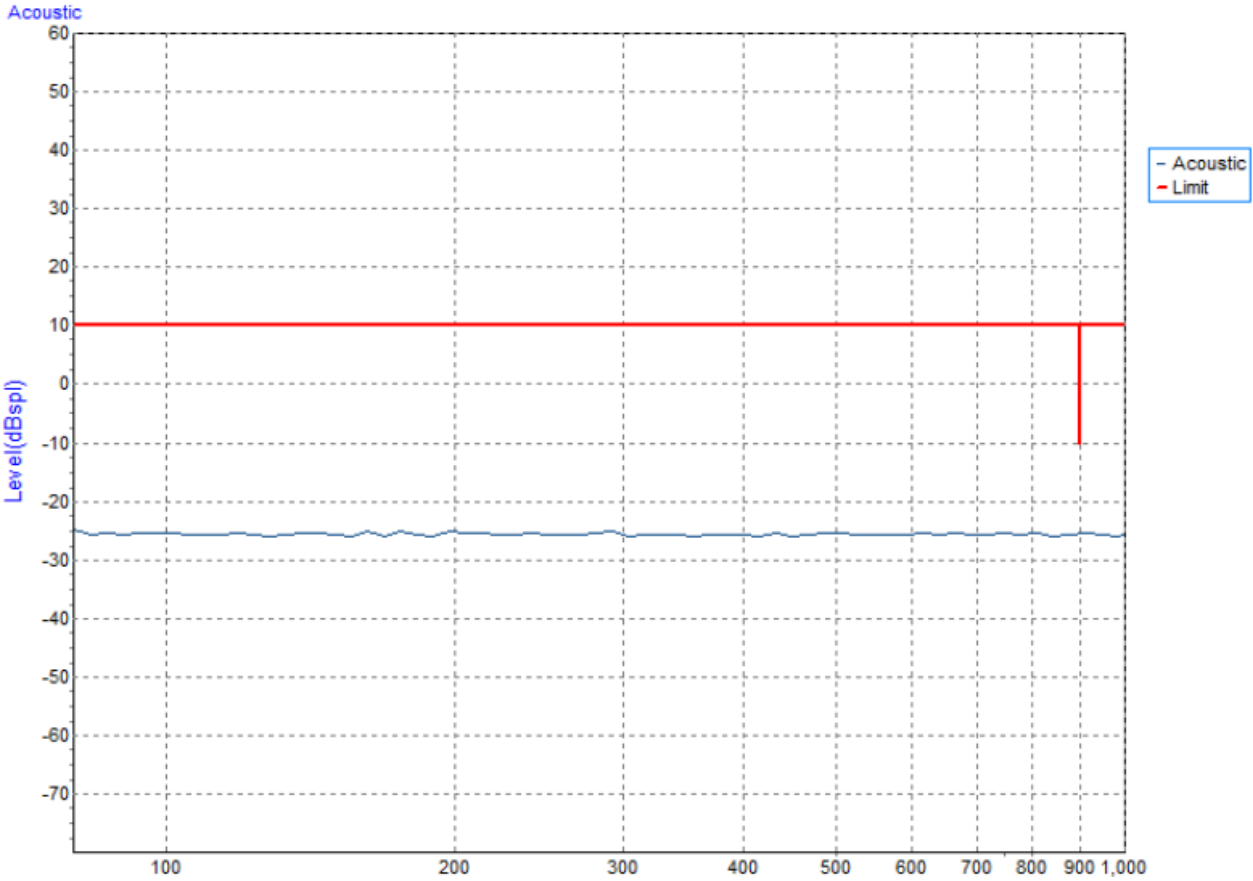

EUT	IP Phone	Model Name	X5S
Temperature	25°C	Relative Humidity	50%
Test Voltage	AC 230V/50Hz	Polarization	Vertical
Test Mode	Handfree		
Note	Adapter Front		

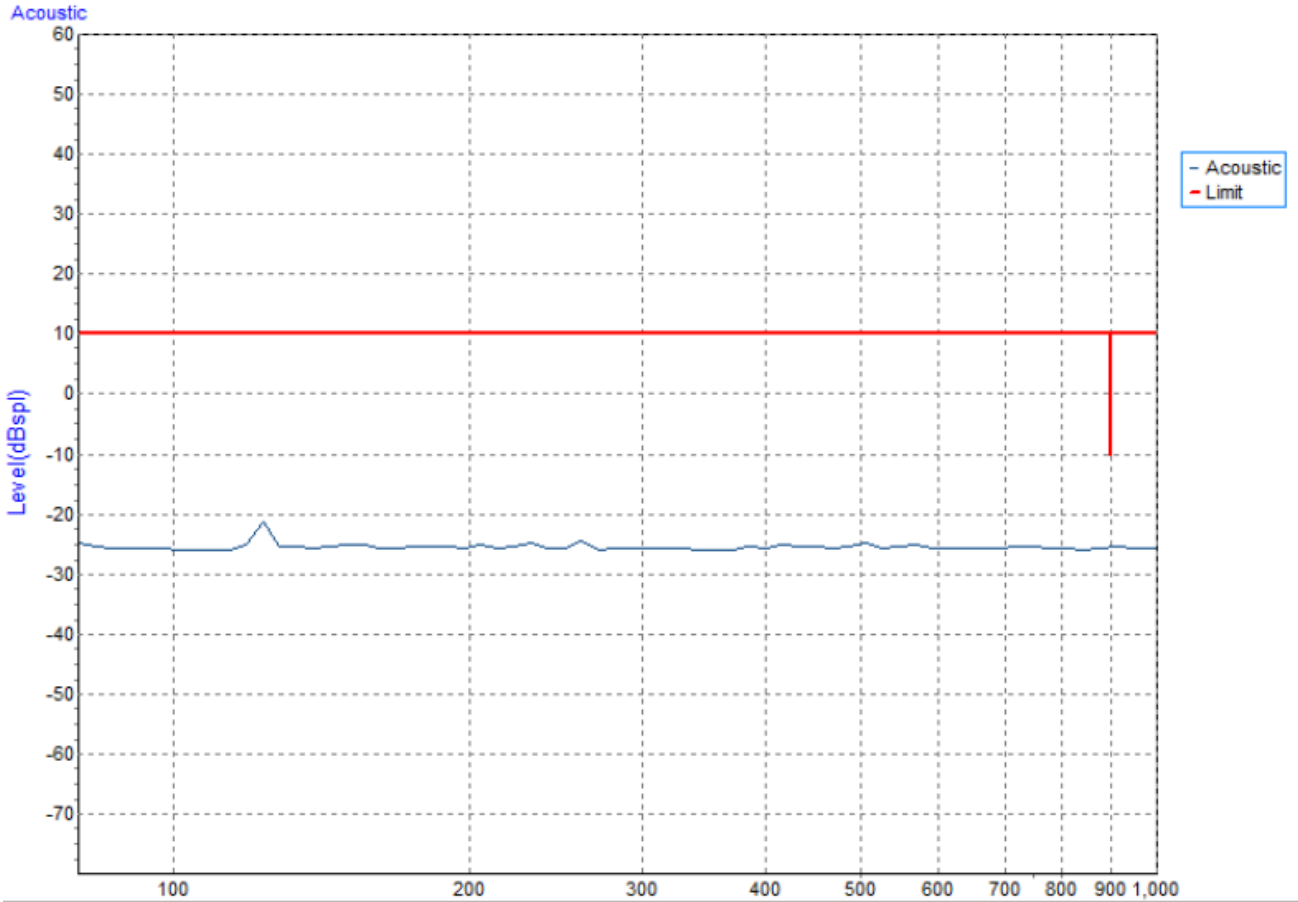

EUT	IP Phone	Model Name	X5S
Temperature	25°C	Relative Humidity	50%
Test Voltage	AC 230V/50Hz	Polarization	Horizontal
Test Mode	Handfree		
Note	Adapter Front		

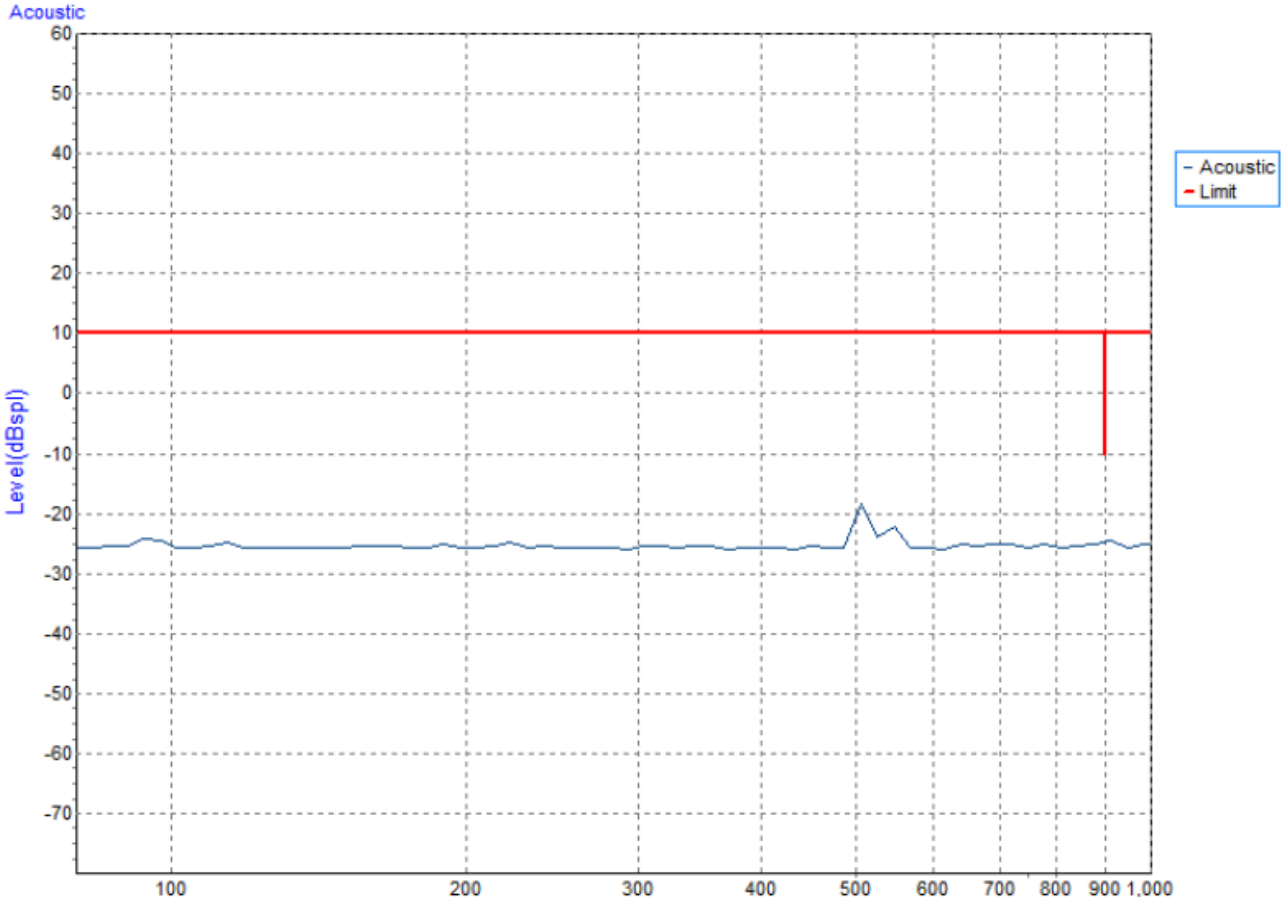

EUT	IP Phone	Model Name	X5S
Temperature	25°C	Relative Humidity	50%
Test Voltage	AC 230V/50Hz	Polarization	Vertical
Test Mode	Handfree		
Note	Adapter Rear		

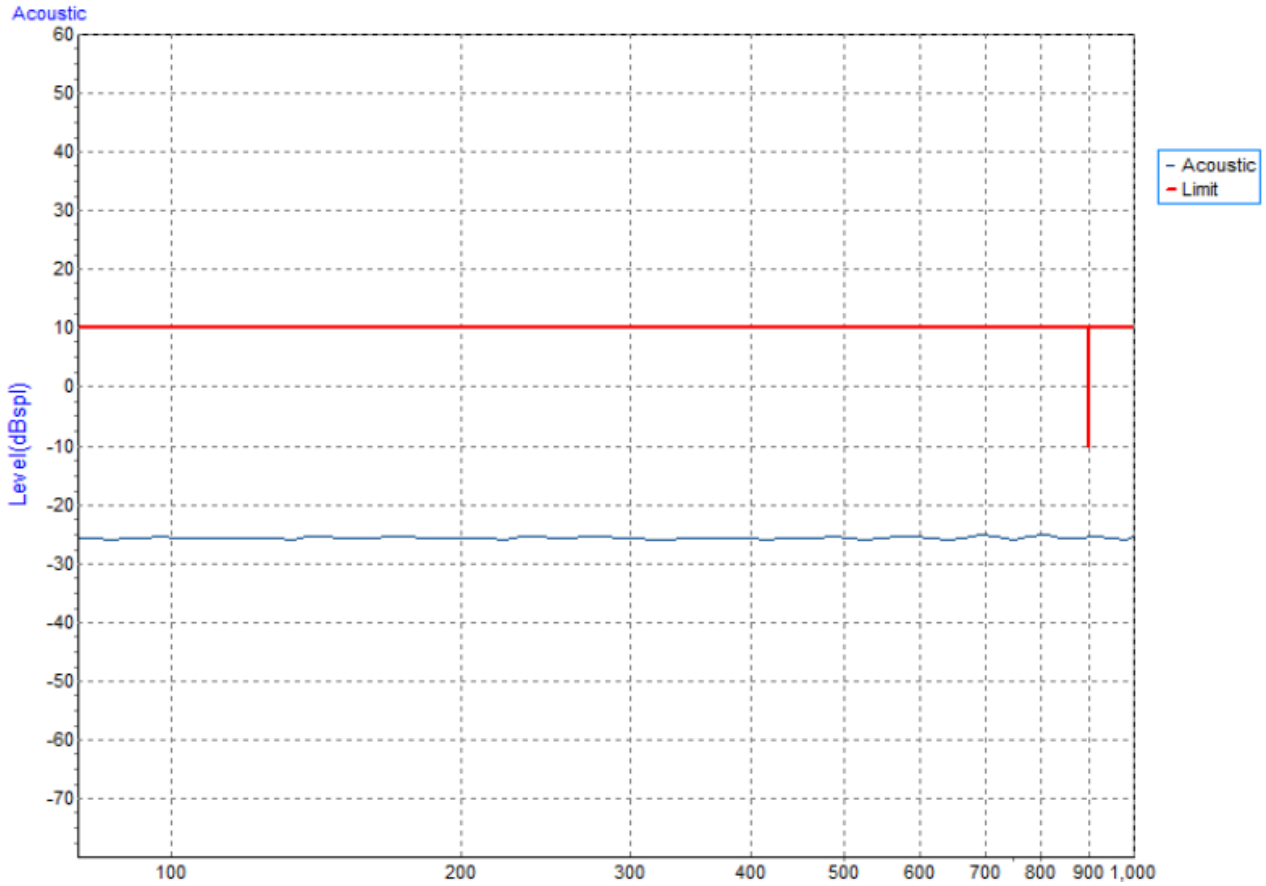

EUT	IP Phone	Model Name	X5S
Temperature	25°C	Relative Humidity	50%
Test Voltage	AC 230V/50Hz	Polarization	Horizontal
Test Mode	Handfree		
Note	Adapter Rear		

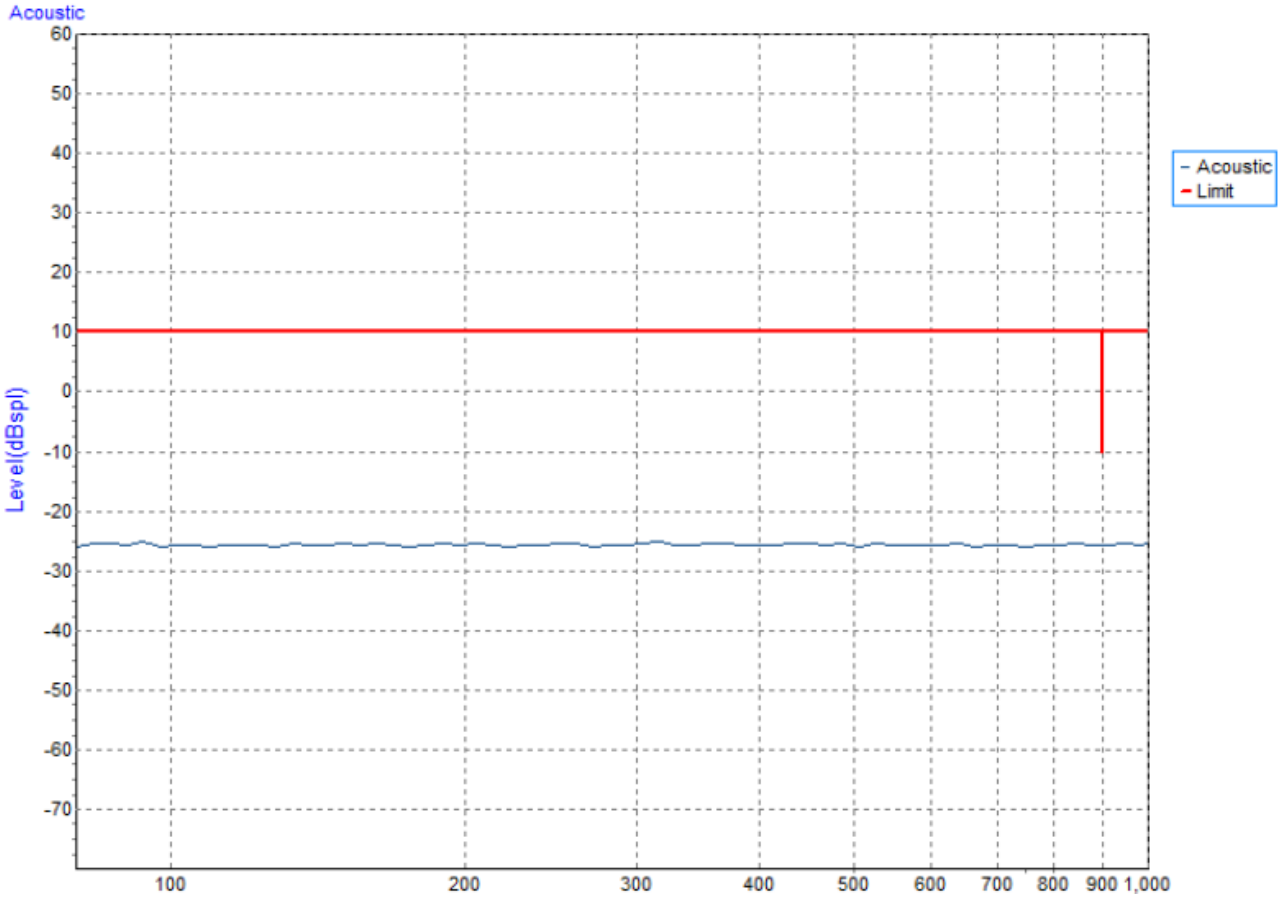

EUT	IP Phone	Model Name	X5S
Temperature	25°C	Relative Humidity	50%
Test Voltage	DC 48V	Polarization	Vertical
Test Mode	Handfree		
Note	PoE Left		

Acoustic

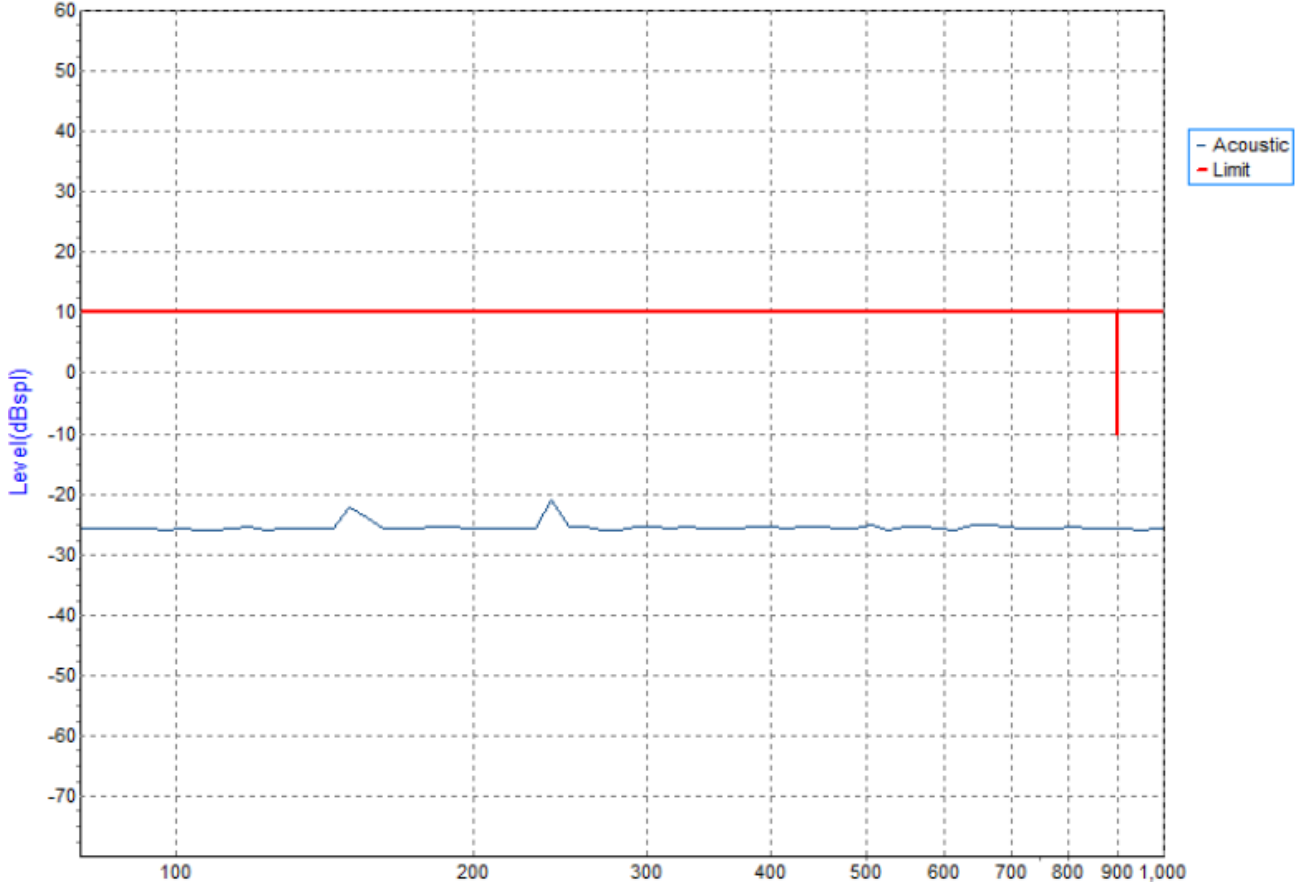

EUT	IP Phone	Model Name	X5S
Temperature	25°C	Relative Humidity	50%
Test Voltage	DC 48V	Polarization	Horizontal
Test Mode	Handfree		
Note	PoE Left		

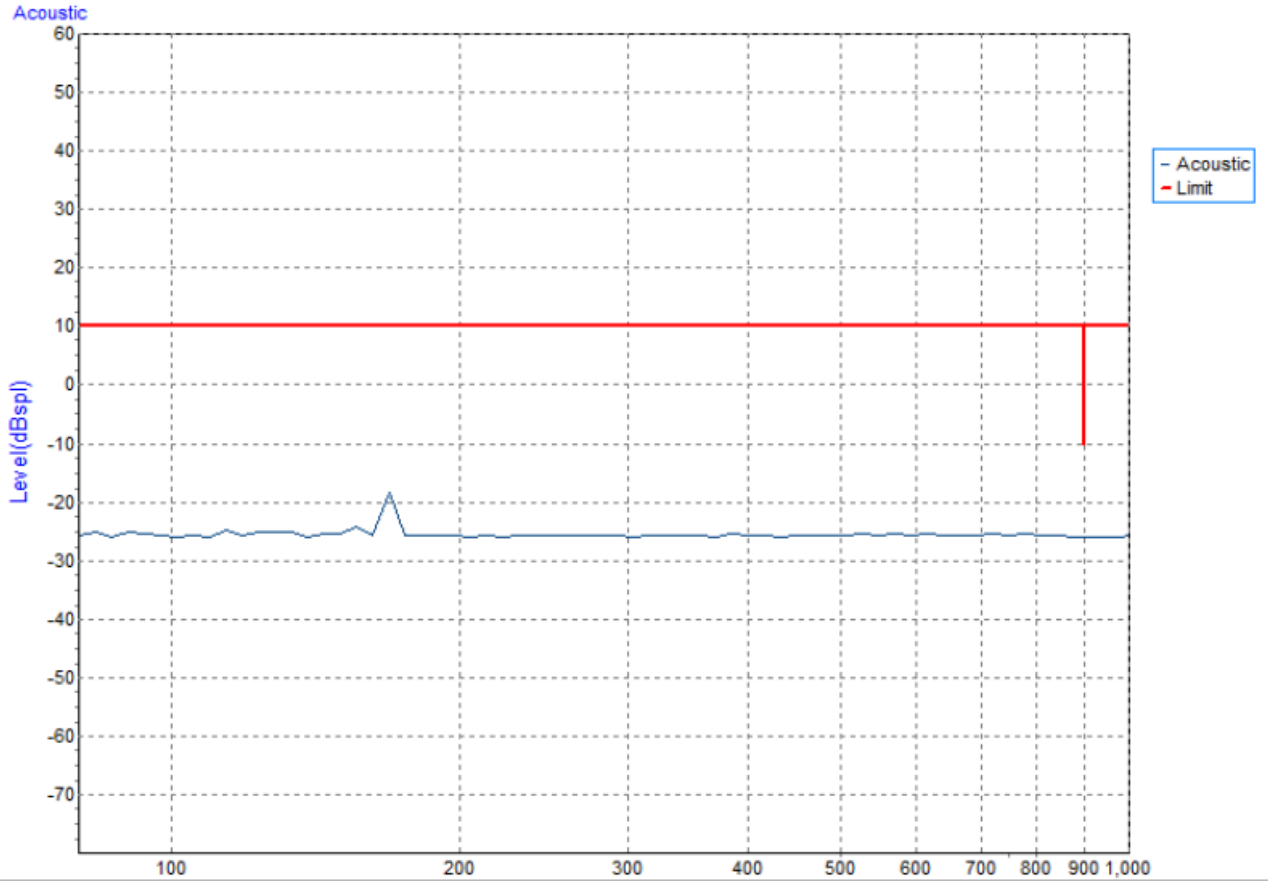

EUT	IP Phone	Model Name	X5S
Temperature	25°C	Relative Humidity	50%
Test Voltage	DC 48V	Polarization	Vertical
Test Mode	Handfree		
Note	PoE Right		

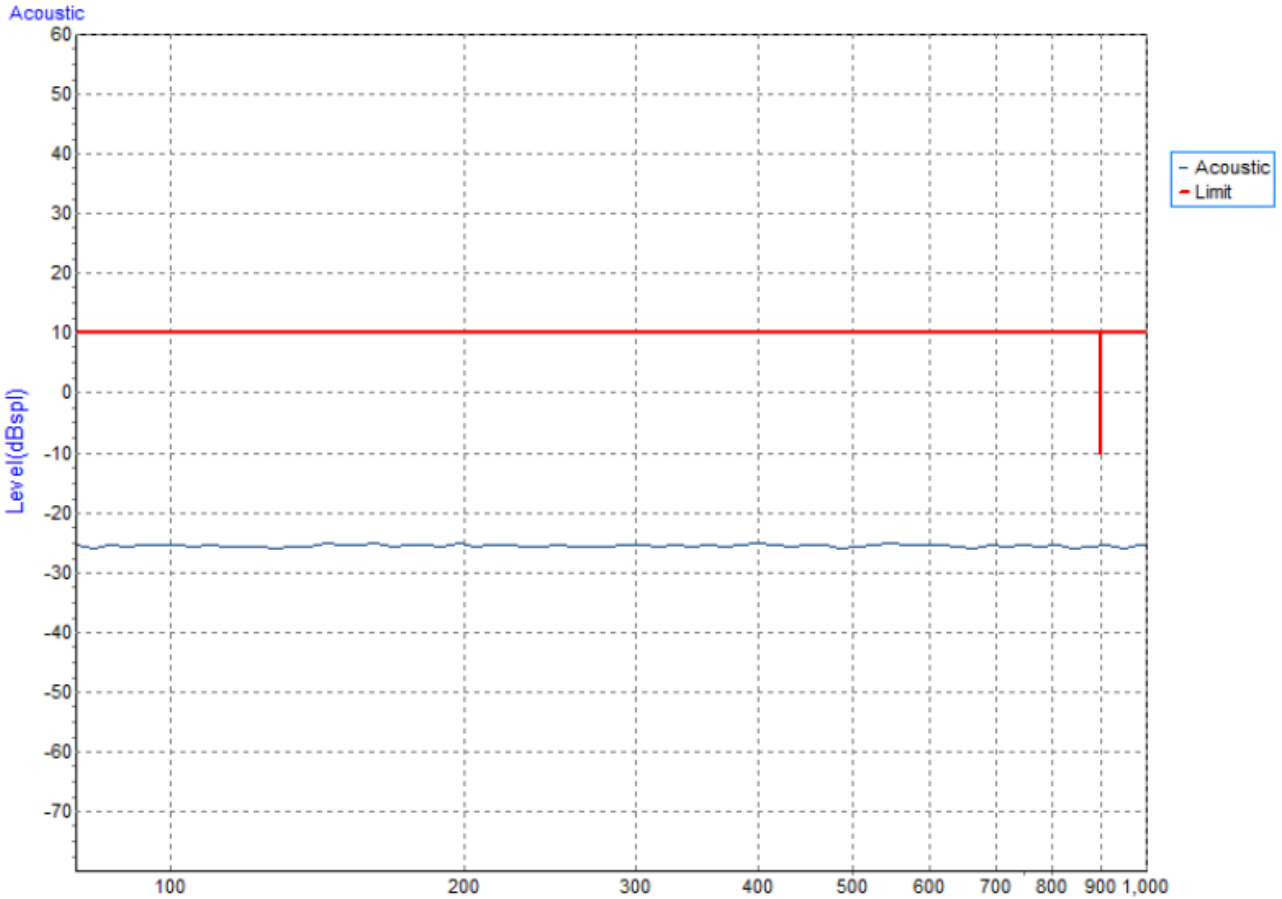

EUT	IP Phone	Model Name	X5S
Temperature	25°C	Relative Humidity	50%
Test Voltage	DC 48V	Polarization	Horizontal
Test Mode	Handfree		
Note	PoE Right		

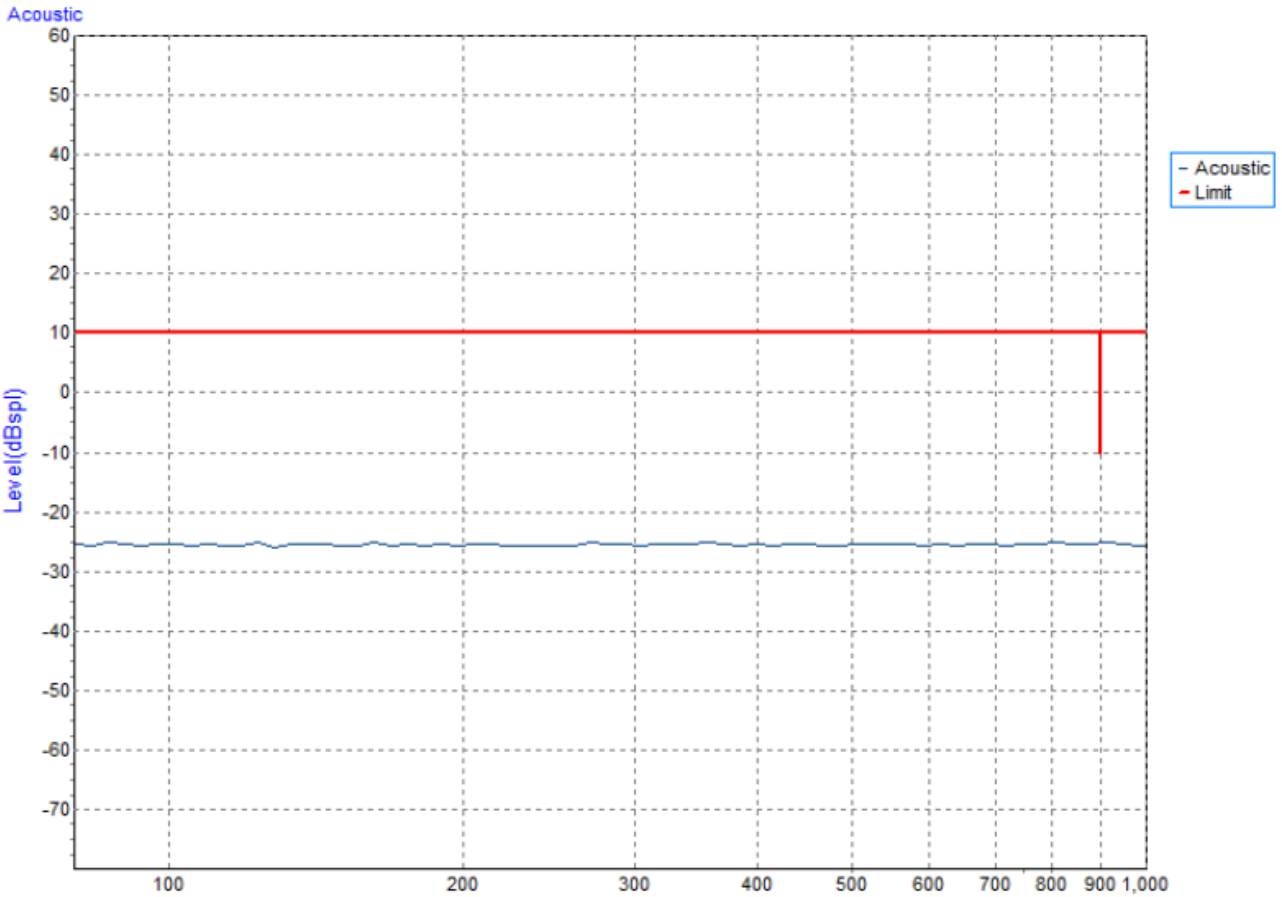

EUT	IP Phone	Model Name	X5S
Temperature	25°C	Relative Humidity	50%
Test Voltage	DC 48V	Polarization	Vertical
Test Mode	Handfree		
Note	PoE Front		

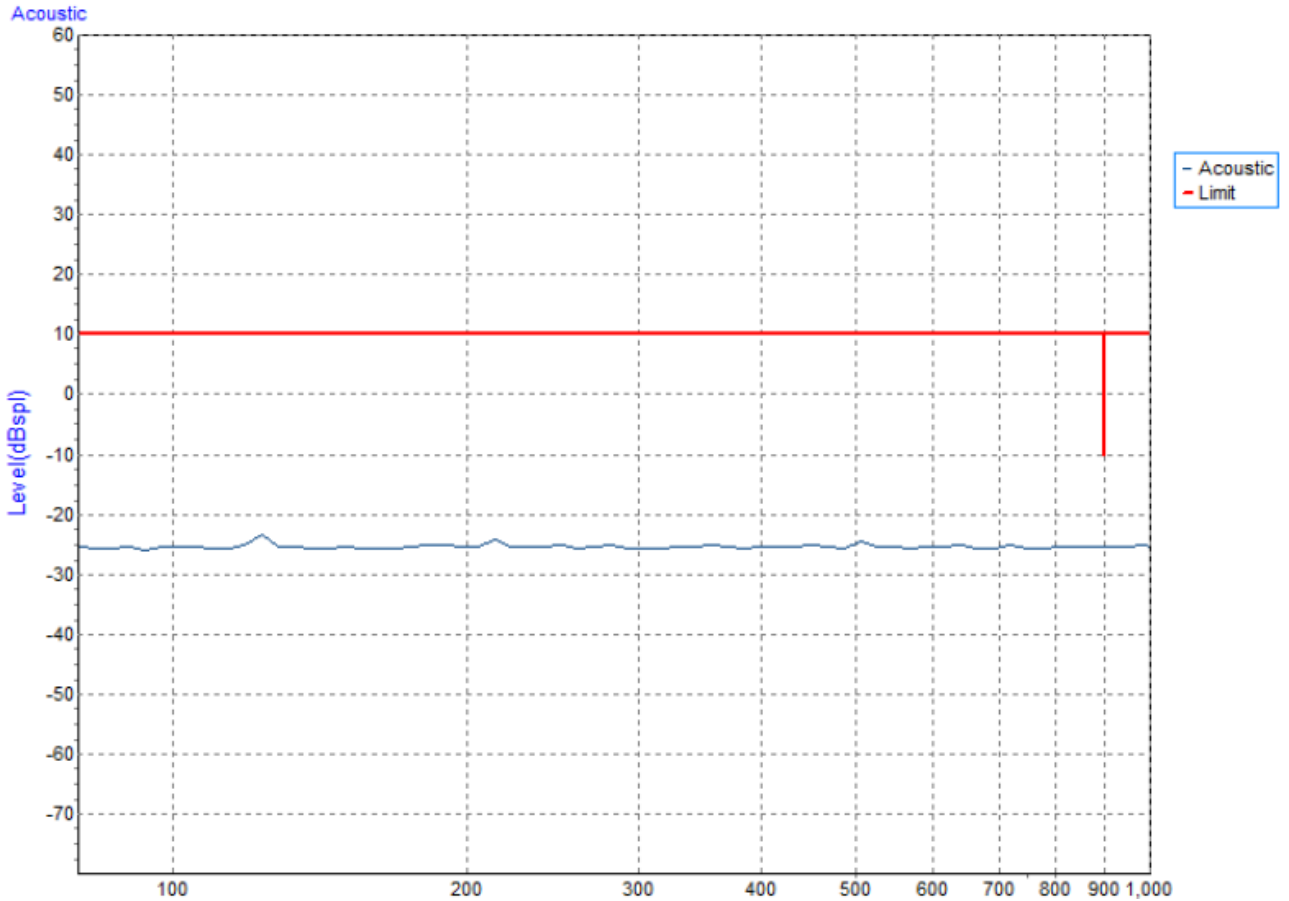

EUT	IP Phone	Model Name	X5S
Temperature	25°C	Relative Humidity	50%
Test Voltage	DC 48V	Polarization	Horizontal
Test Mode	Handfree		
Note	PoE Front		

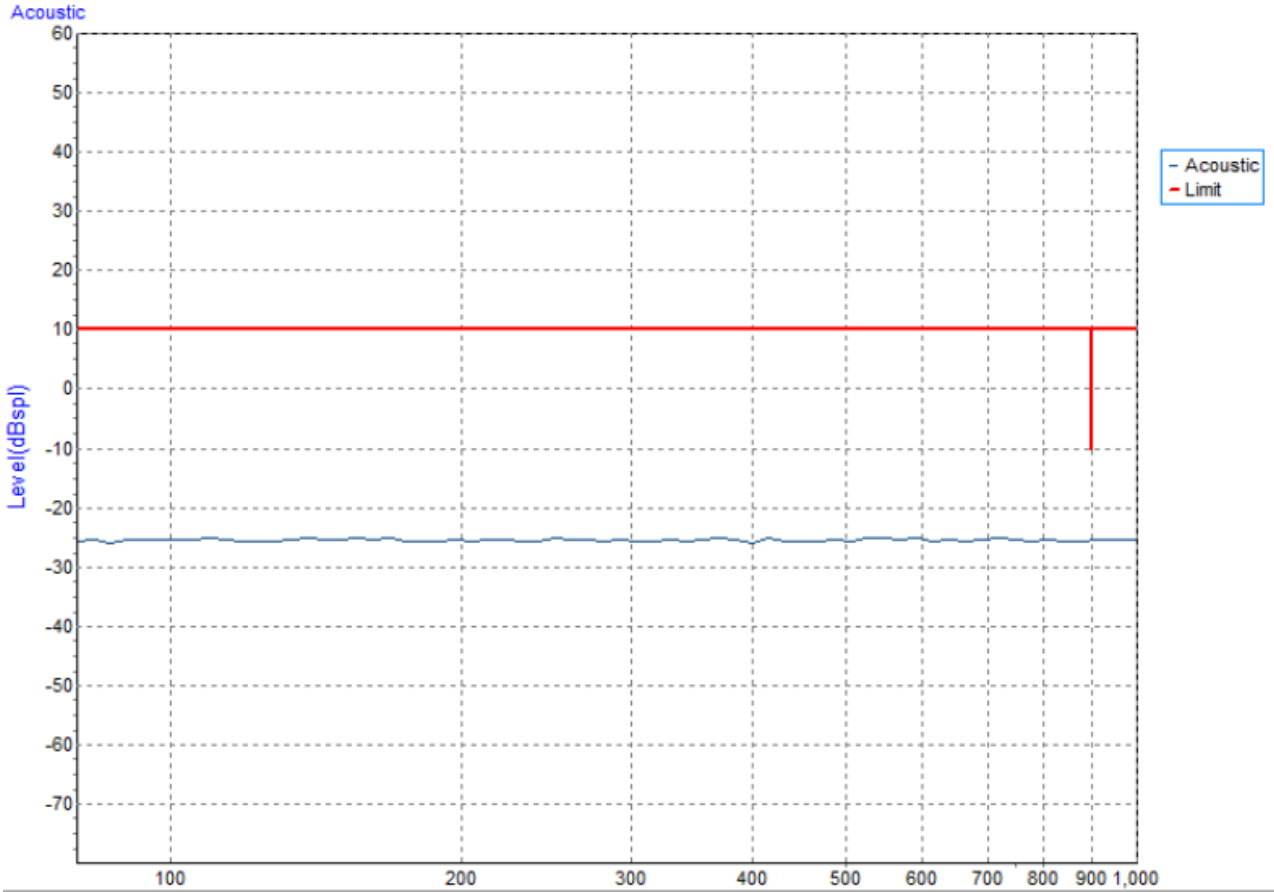

EUT	IP Phone	Model Name	X5S
Temperature	25°C	Relative Humidity	50%
Test Voltage	DC 48V	Polarization	Vertical
Test Mode	Handfree		
Note	PoE Rear		

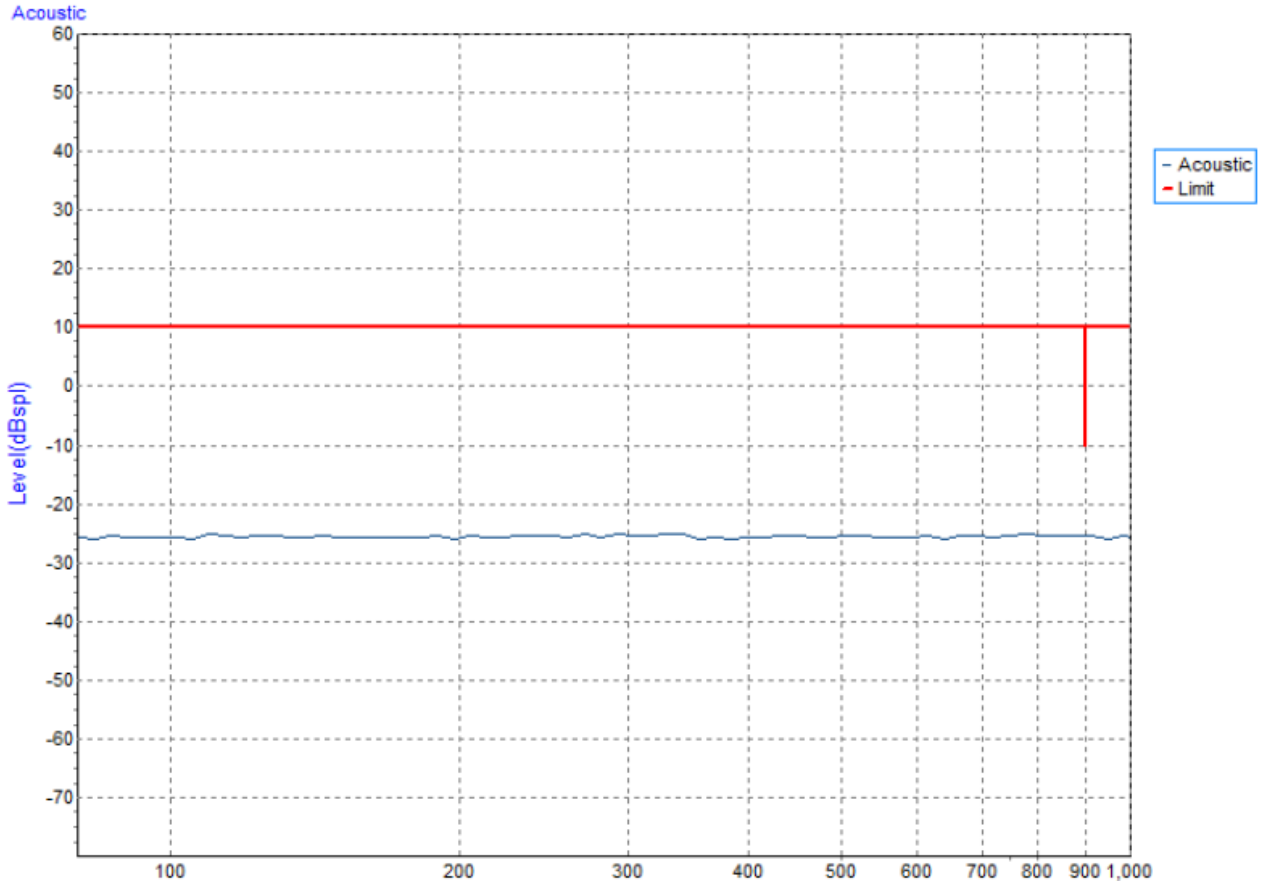

EUT	IP Phone	Model Name	X5S
Temperature	25°C	Relative Humidity	50%
Test Voltage	DC 48V	Polarization	Horizontal
Test Mode	Handfree		
Note	PoE Rear		

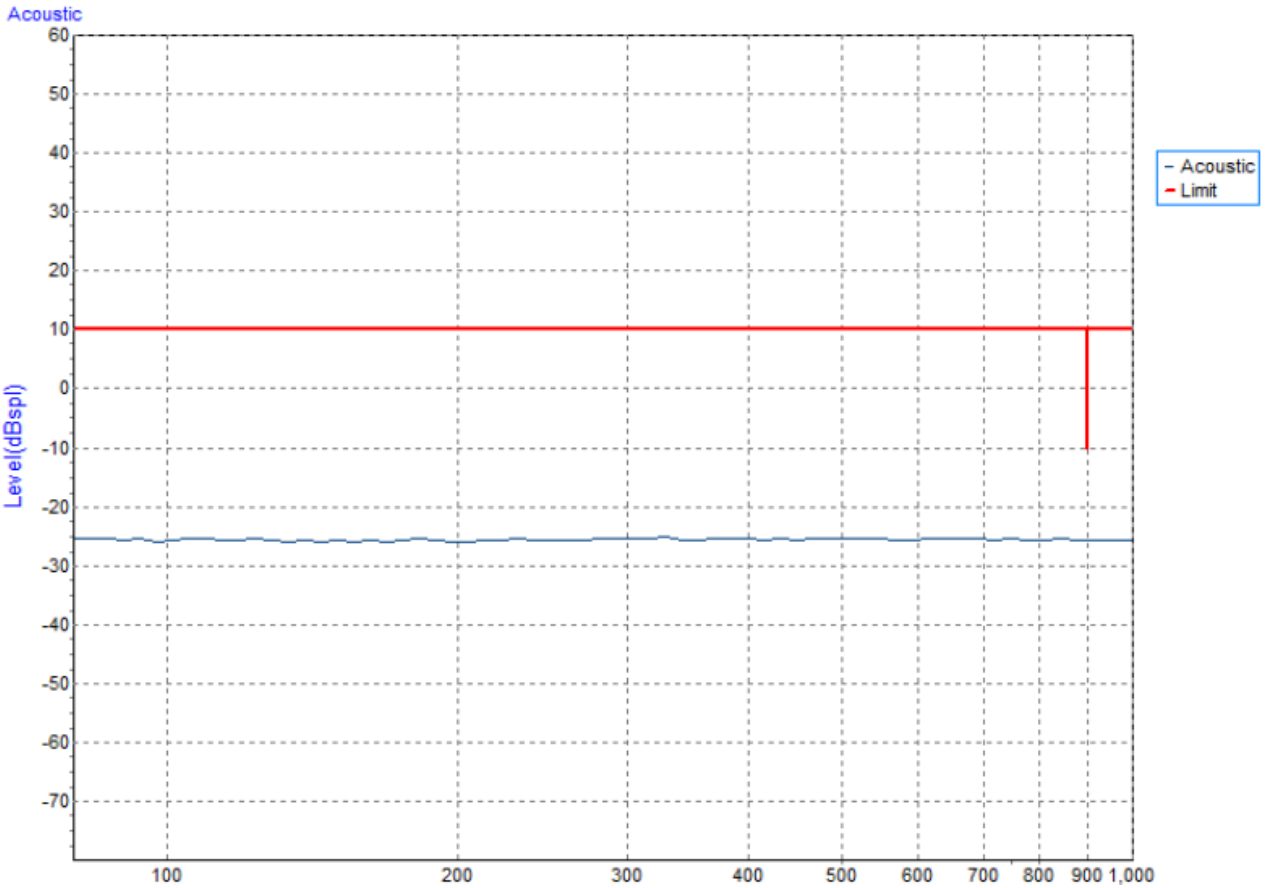

5.5 ELECTRICAL FAST TRANSIENT/BURST IMMUNITY TEST (EFT/BURST)

5.5.1 TEST SPECIFICATION

Basic Standard	EN 61000-4-4
Required Performance	B
Test Voltage	Power Line: ± 0.5 kV, ± 1 kV Signal/Control Line: ± 0.5 kV
Polarity	Positive & Negative
Impulse Frequency	5 kHz: except for xDSL equipment 100 kHz: only for single lines of xDSL equipment.
Impulse Wave shape	5/50 ns
Burst Duration	15 ms
Burst Period	300 ms
Test Duration	Not less than 1 min.

5.5.2 MEASUREMENT INSTRUMENTS

Item	Kind of Equipment	Manufacturer	Type No.	Serial No.	Calibrated until
1	Capacitor Clamp	Thermo KeyTek	CCL	0502215	Feb. 24, 2018
2	THE MODULAR SOLUTION FOR 6 KV APPLICATIONS	Teseq	NSG 3060	1423	Sep. 04, 2017
3	Measurement Software	Teseq	Win 3000 Version 1.2.0	N/A	N/A

Remark: "N/A" denotes no model name, no serial No. or no calibration specified.

All calibration period of equipment list is one year.

5.5.3 TEST PROCEDURE

The EUT and support equipment(s) are placed on a table that is 0.8 meter high above a metal ground plane and should be located 0.1 m \pm 0.01m high above the Ground Reference Plane (1m*1m min. and 0.65mm thick min).

The other condition as following manner:

- The length of power cord between the coupling device and the EUT should not exceed 1 meter.
- Both positive and negative polarity discharges were applied.
- The duration time of each test sequential was 1 minute

5.5.4 DEVIATION FROM TEST STANDARD

No deviation

5.5.5 TEST SETUP

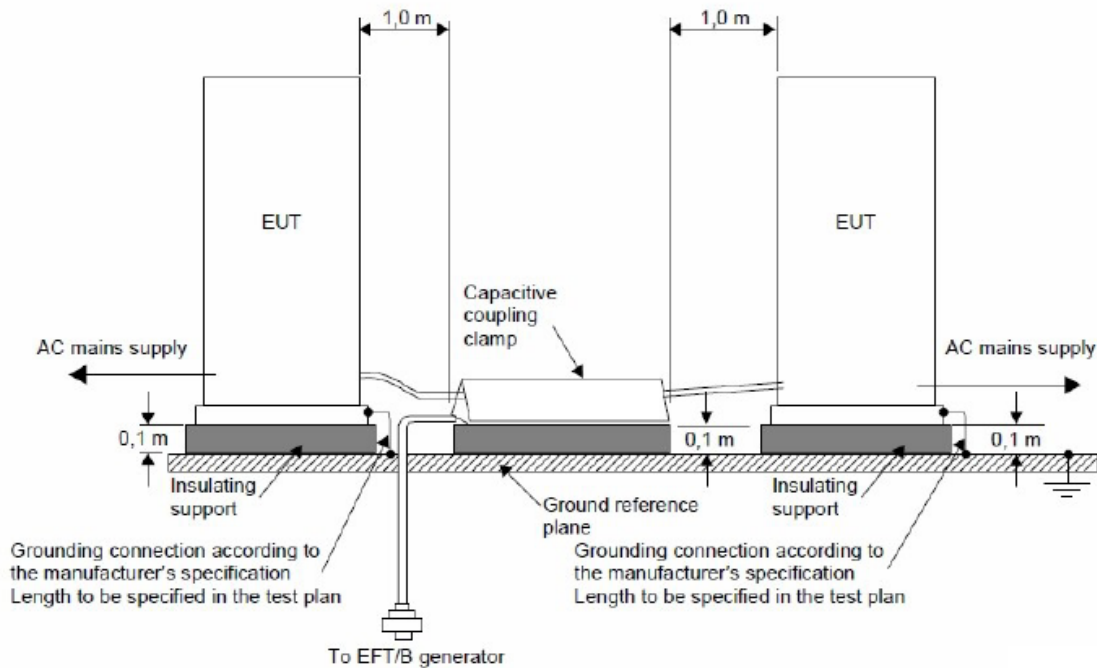
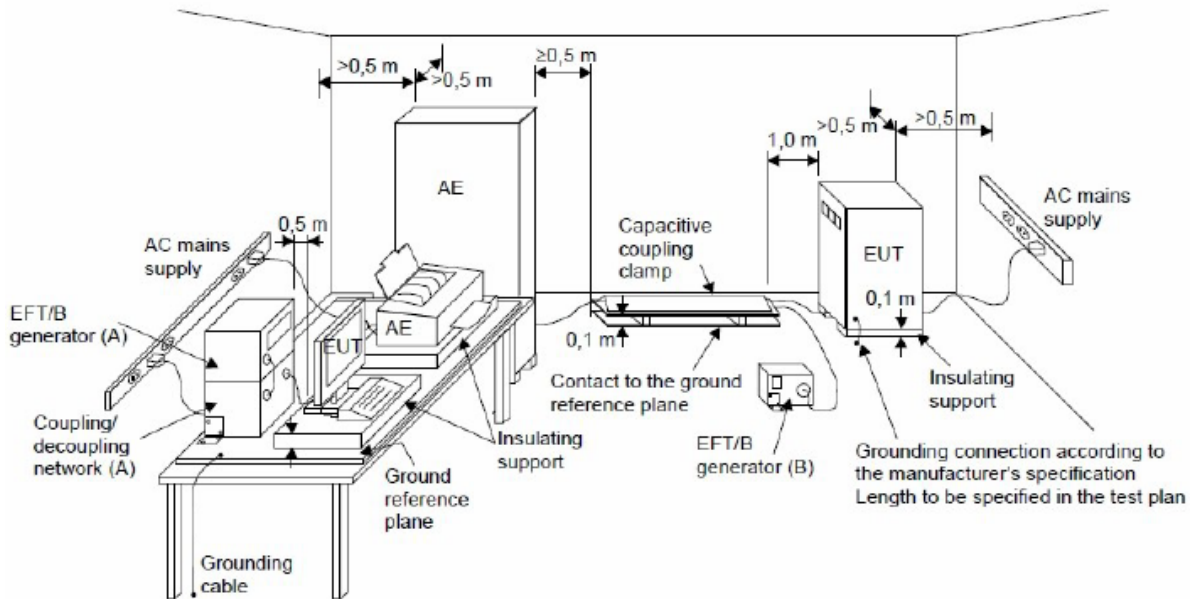

Note:

TABLE-TOP EQUIPMENT

The configuration consisted of a wooden table (0.8m high) standing on the Ground Reference Plane and should be located 0.1 m+/- 0.01m above the Ground Reference Plane. The GRP consisted of a sheet of aluminum (at least 0.25mm thick and 2.5m square) connected to the protective grounding system. A minimum distance of 0.5m was provided between the EUT and the walls of the laboratory or any other metallic structure.

FLOOR-STANDING EQUIPMENT

The EUT installed in a representative system as described in EN 61000-4-4 and its cables were isolated from the Ground Reference Plane by an insulating support that is 0.1-meter thick. The GRP consisted of a sheet of aluminum (at least 0.25mm thick and 2.5m square) connected to the protective grounding system.

5.5.6 TEST RESULTS

EUT	IP Phone	Model Name	X5S
Temperature	25°C	Relative Humidity	52%
Test Voltage	AC 230V/50Hz		
Test Mode	Handfree,Handset,Headphone		

EUT Ports Tested		Polarity	Repetition Frequency	Test Level	Criterion	Result	Judgment
				1kV			
AC Power Port	Line (L)	+	5 kHz	A	B	A	PASS
		-	5 kHz	A			
	Neutral (N)	+	5 kHz	A	B	A	PASS
		-	5 kHz	A			
	Ground (PE)	+	5 kHz	N/A	B	N/A	N/A
		-	5 kHz	N/A			

EUT Ports Tested		Polarity	Repetition Frequency	Test Level	Criterion	Result	Judgment
				0.5 kV			
Signal Port	PC	+	5 kHz	B	B	B	PASS
		-	5 kHz	B			
Signal Port	Internet	+	5 kHz	B	B	B	PASS
		-	5 kHz	B			

Note:

- 1) P/N denotes the Positive/Negative polarity of the output voltage.
- 2) N/A - denotes test is not applicable in this test report
- 3) Criterion A: No observation of any performance degradation.
- 4) Criterion B: Some degradation of performance is observed but the equipment continues to operate as intended.
- 5) Criterion C: Loss of functionality, but self-recoverable by user, without loss of information or settings.

5.6 SURGE IMMUNITY TEST

5.6.1 TEST SPECIFICATION

Basic Standard	EN 61000-4-5
Required Performance	B
Wave-Shape	Combination Wave for power lines 1.2/50 us Open Circuit Voltage 8 /20 us Short Circuit Current
Test Voltage	Power Line: ± 0.5 kV, ± 1 kV, ± 2 kV
Surge Input/Output	L-N, L-PE, N-PE
Generator Source Impedance	2 ohm between networks 12 ohm between network and ground
Polarity	Positive/Negative
Phase Angle:	AC Port: $0^\circ/90^\circ/180^\circ/270^\circ$
Pulse Repetition Rate	1 time / min. (maximum)
Number of Tests	5 positive and 5 negative at selected points

5.6.2 MEASUREMENT INSTRUMENTS

Item	Kind of Equipment	Manufacturer	Type No.	Serial No.	Calibrated until
1	THE MODULAR SOLUTION FOR 6 KV APPLICATIONS	Teseq	NSG 3060	1423	Sep. 04, 2017
2	Measurement Software	Teseq	Win 3000 Version 1.2.0	N/A	N/A

Remark: "N/A" denotes no model name, no serial No. or no calibration specified.
All calibration period of equipment list is one year.

5.6.3 TEST PROCEDURE

a. For EUT power supply:

The surge is to be applied to the EUT power supply terminals via the capacitive coupling network. Decoupling networks are required in order to avoid possible adverse effects on equipment not under test that may be powered by the same lines, and to provide sufficient decoupling impedance to the surge wave. The power cord between the EUT and the coupling/decoupling networks shall be 2meters in length (or shorter).

b. For test applied to unshielded unsymmetrically operated interconnection lines of EUT :

The surge is applied to the lines via the capacitive coupling. The coupling /decoupling networks shall not influence the specified functional conditions of the EUT. The interconnection line between the EUT and the coupling/decoupling networks shall be 2 meters in length (or shorter).

c. For test applied to unshielded symmetrically operated interconnection /telecommunication lines of EUT :

The surge is applied to the lines via gas arrestors coupling. Test levels below the ignition point of the coupling arrestor cannot be specified. The interconnection line between the EUT and the coupling/decoupling networks shall be 2 meters in length (or shorter).

5.6.4 DEVIATION FROM TEST STANDARD

No deviation

5.6.5 TEST SETUP

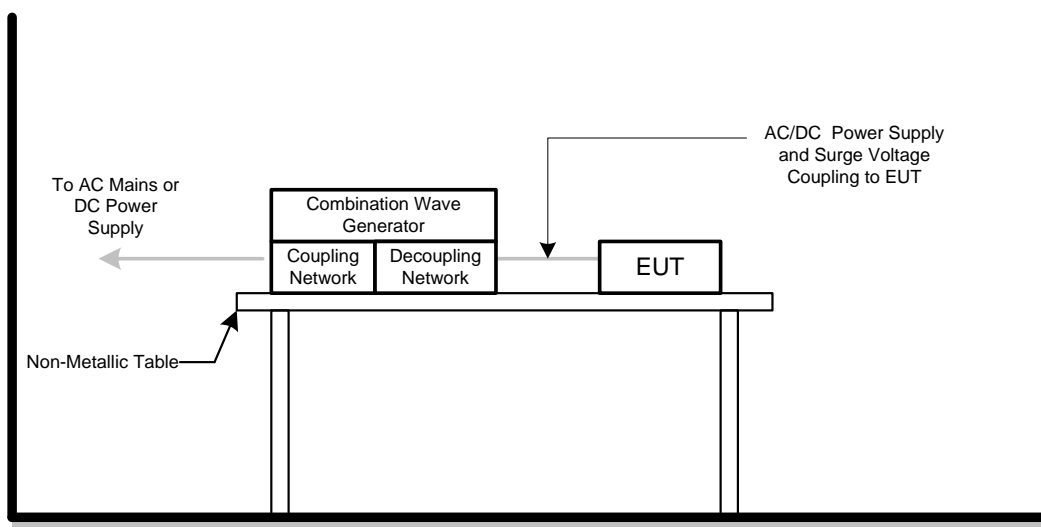

5.6.6 TEST RESULTS

EUT	IP Phone	Model Name	X5S
Temperature	25°C	Relative Humidity	52%
Test Voltage	AC 230V/50Hz		
Test Mode	Handfree,Handset,Headphone		

Wave Form EUT Ports Tested		1.2/50(8/20)Tr/Thµs						Criterion	Result	Judgment
		Polarity	Phase	Voltage						
				0.5kV	1kV	-- kV	-- kV			
AC	L – N (2 ohm)	+/-	0°	A	A	-	-	B	A	PASS
		+/-	90°	A	A	-	-			
		+/-	180°	A	A	-	-			
		+/-	270°	A	A	-	-			

Note:

- 1) Polarity and Numbers of Impulses: 5 Pst / Ngst at each tested mode
- 2) N/A - denotes test is not applicable in this Test Report
- 3) Criterion A: No observation of any performance degradation.
- 4) Criterion B: Some degradation of performance is observed but the equipment continues to operate as intended.
- 5) Criterion C: Loss of functionality, but self-recoverable by user, without loss of information or settings.

5.7 IMMUNITY TO CONDUCTED DISTURBANCES, INDUCED BY RADIO-FREQUENCY FIELDS TEST (CS)

5.7.1 TEST SPECIFICATION

Basic Standard	EN 61000-4-6
Required Performance	A
Frequency Range	0.15 MHz - 80 MHz
Field Strength	3 V (unmodulated, r.m.s.)
Modulation	1 kHz Sine Wave, 80%, AM Modulation
Frequency Step	1% of fundamental
Dwell Time	at least 3 seconds

5.7.2 MEASUREMENT INSTRUMENTS

Item	Kind of Equipment	Manufacturer	Type No.	Serial No.	Calibrated until
1	Power CDN	FCC	FCC-801-M2/M3-16A	100270	Mar. 26, 2018
2	Power Amplifier	Teseq	CBA230M-080	T43748	Mar. 26, 2018
3	Signal Generator	HP	8648A	3636A02964	Mar. 26, 2018
4	Measurement Software	Farad	EZ-CS?(V2 .0.1.2)	N/A	N/A
5	Signal Line CDN	FCC	F-090407-1004-1	100518	Mar. 26, 2018
6	Power Amplifier	Teseq	CBA230M-080	T43748	Mar. 26, 2018
7	Signal Generator	HP	8648A	3636A02964	Mar. 26, 2018

Remark: "N/A" denotes no model name, no serial No. or no calibration specified.

All calibration period of equipment list is one year.

5.7.3 TEST PROCEDURE

The EUT and support equipment, are placed on a table that is 0.8 meter above a metal ground plane measured 1m*1m min. and 0.65mm thick min.

The other condition as following manner:

- a. The field strength level was 3 V (unmodulated, r.m.s.)
- b. The frequency range is swept from 150 kHz to 80 MHz, with the signal 80% amplitude modulated with a 1 kHz sine wave. The rate of sweep did not exceed 1.5×10^{-3} decade/s. Where the frequency range is swept incrementally, the step size was 1% of fundamental.
- c. The dwell time at each frequency shall be not less than the time necessary for the EUT to be able to respond.

5.7.4 DEVIATION FROM TEST STANDARD

No deviation

5.7.5 TEST SETUP

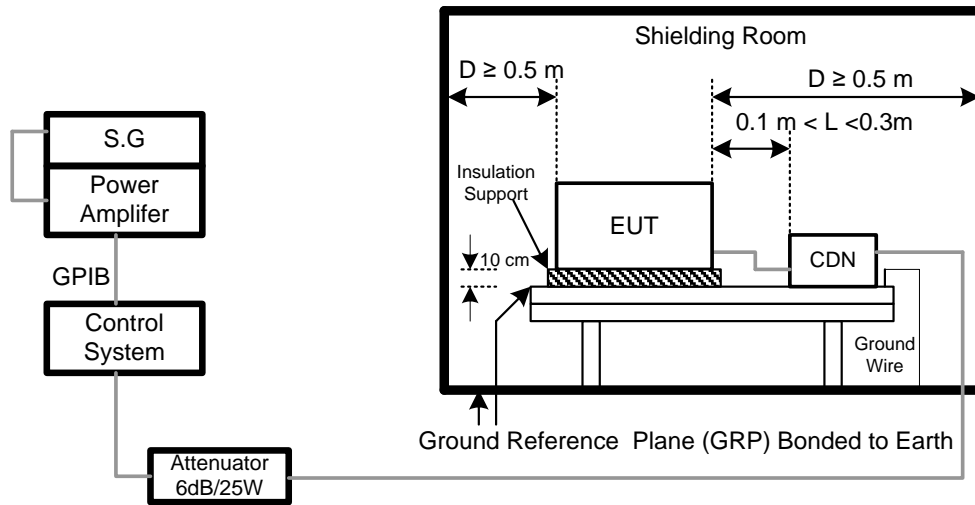

NOTE:

FLOOR-STANDING EQUIPMENT

The equipment to be tested is placed on an insulating support of 0.1 meters height above a ground reference plane. All relevant cables shall be provided with the appropriate coupling and decoupling devices at a distance between 0.1 meters and 0.3 meters from the projected geometry of the EUT on the ground reference plane.

5.7.6 TEST RESULTS

EUT	IP Phone	Model Name	X5S
Temperature	25°C	Relative Humidity	54%
Test Voltage	AC 230V/50Hz		
Test Mode	Handfree,Handset,Headphone		

Test Ports (Mode)	Freq.Range (MHz)	Field Strength	Criteria	Results	Judgment
Input/ Output AC.PowerPort	0.15 ---80	3V(unmodulated, r.m.s) AM Modulated 1000Hz, 80%	A	A	PASS
Input/ Output DC. PowerPort	0.15 --- 80		A	N/A	N/A
Signal Line (PC)	0.15 --- 80		A	A	PASS
Signal Line (Internet)	0.15 --- 80		A	A	PASS

Note:

- 1). N/A - denotes test is not applicable in this test report.
- 2) Criterion A: No observation of any performance degradation.
- 3) Criterion B: Some degradation of performance is observed but the equipment continues to operate as intended.
- 4) Criterion C: Loss of functionality, but self-recoverable by user, without loss of information or settings.

EUT	IP Phone	Model Name	X5S
Temperature	25°C	Relative Humidity	54%
Test Voltage	AC 230V/50Hz		
Test Mode	Handset		
Note	Adapter, Inject Internet Port, CDN T8		

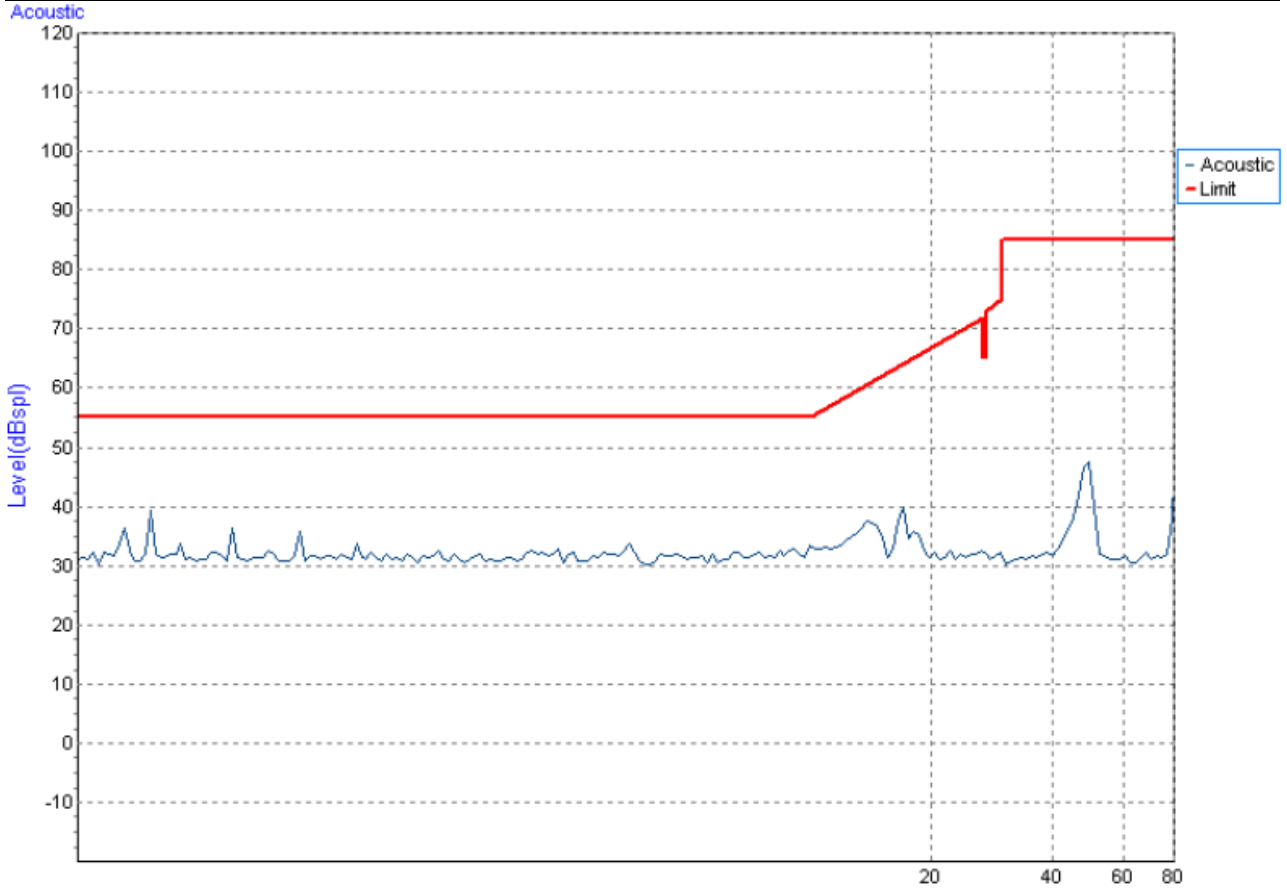

EUT	IP Phone	Model Name	X5S
Temperature	25°C	Relative Humidity	54%
Test Voltage	AC 230V/50Hz		
Test Mode	Handset		
Note	Adapter CDN M2		

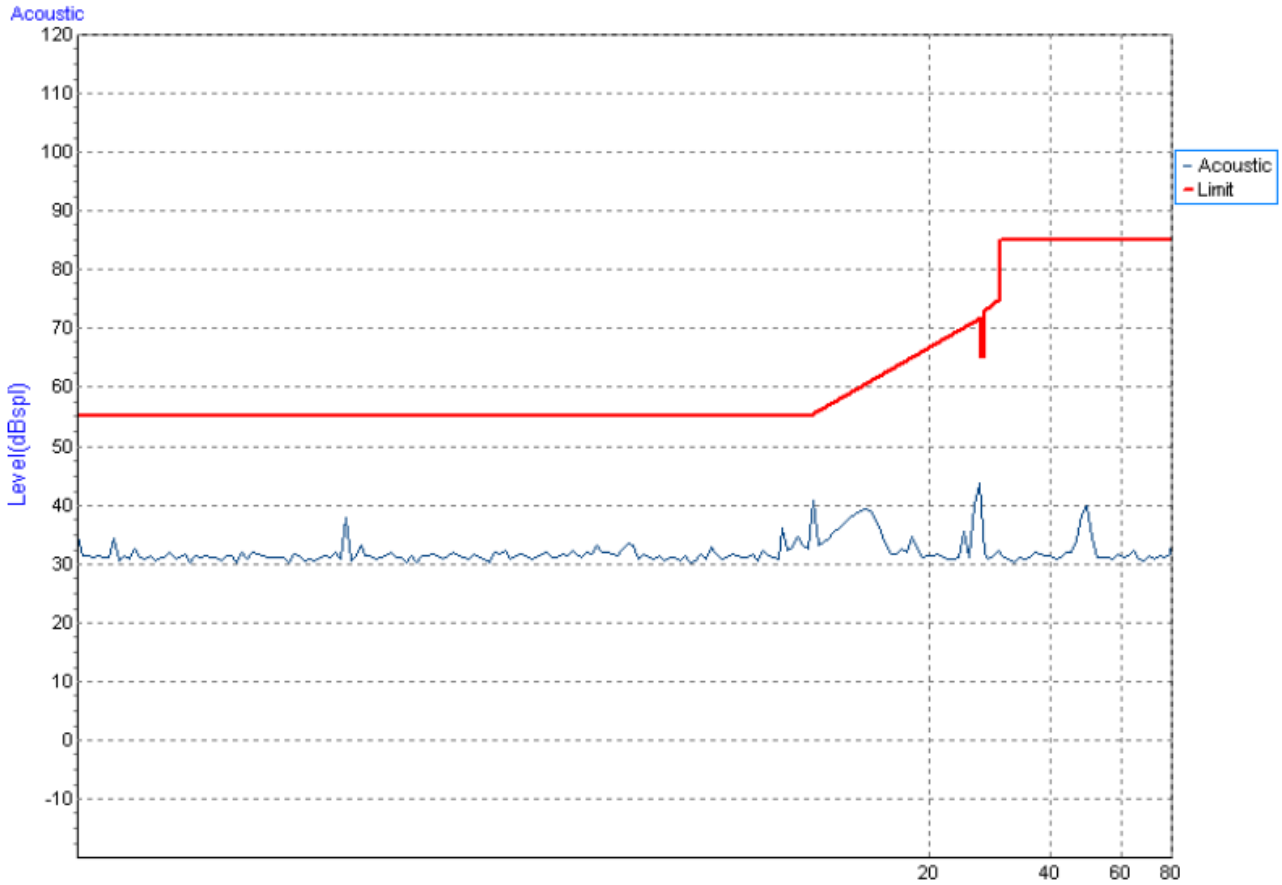

EUT	IP Phone	Model Name	X5S
Temperature	25°C	Relative Humidity	54%
Test Voltage	AC 230V/50Hz		
Test Mode	Handset		
Note	Adapter, Inject PC Port, CDN T8		

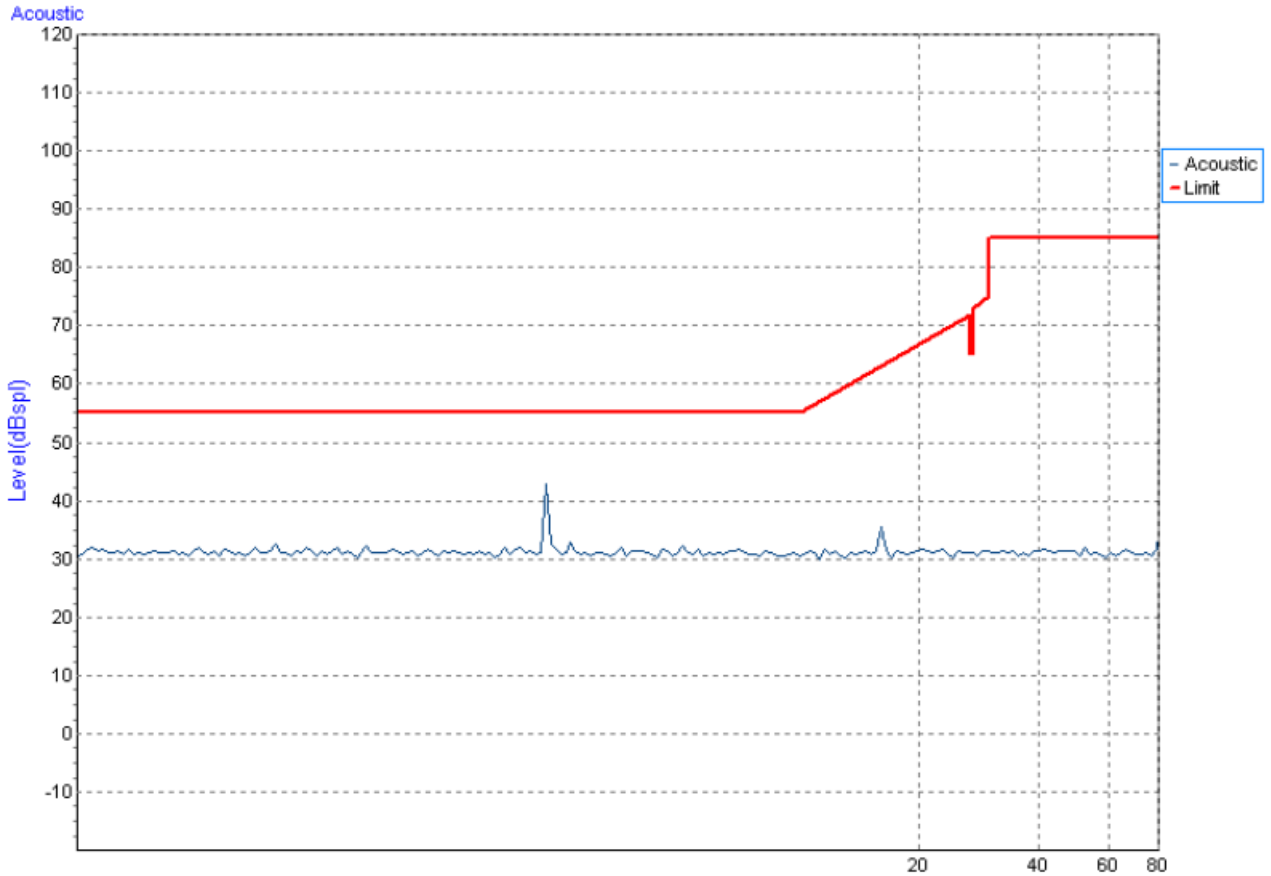

EUT	IP Phone	Model Name	X5S
Temperature	25°C	Relative Humidity	54%
Test Voltage	AC 230V/50Hz		
Test Mode	Handset		
Note	PoE, Inject Internet Port, CDN T8		

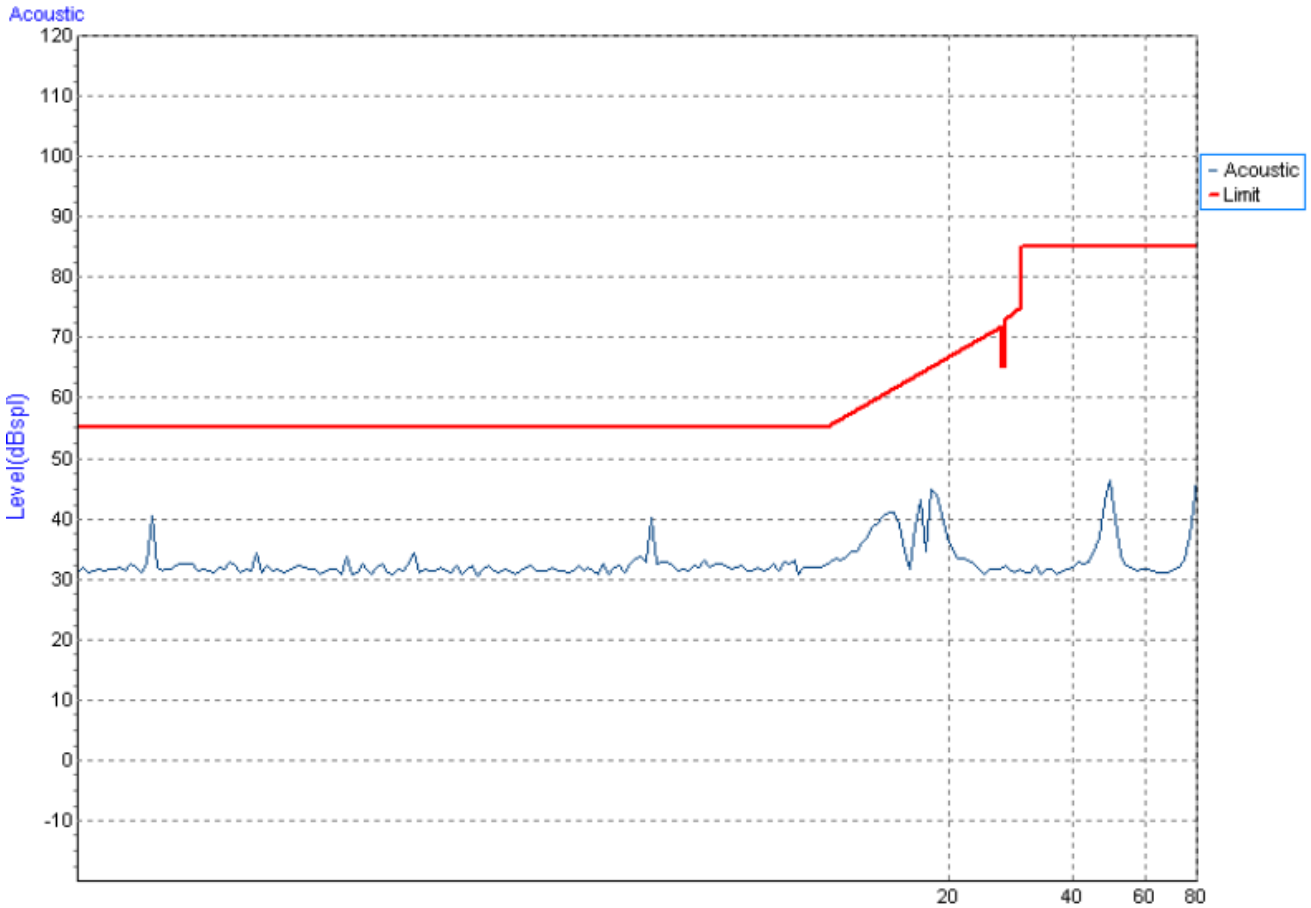

EUT	IP Phone	Model Name	X5S
Temperature	25°C	Relative Humidity	54%
Test Voltage	AC 230V/50Hz		
Test Mode	Handset		
Note	PoE, Inject PC Port, CDN T8		

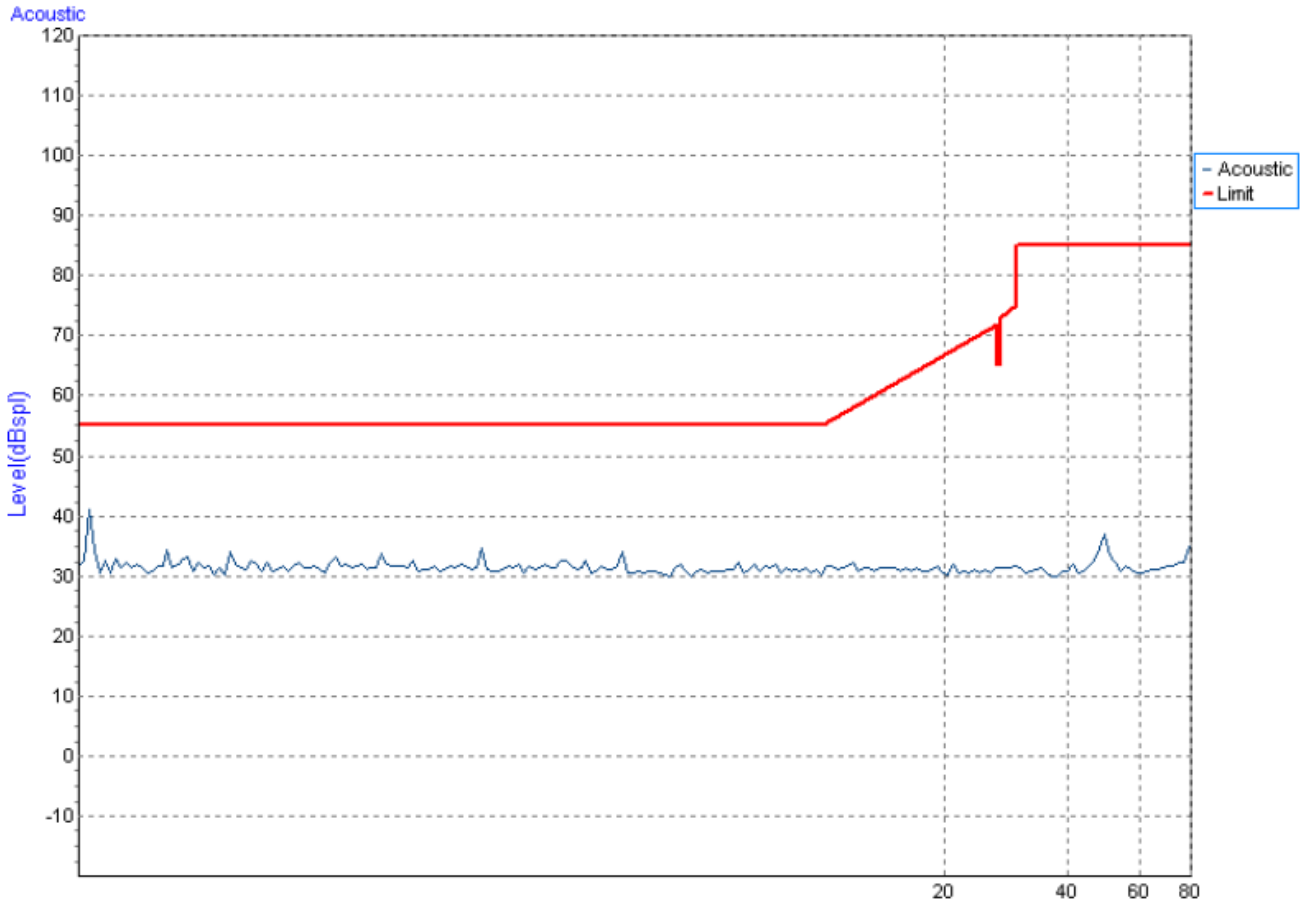

EUT	IP Phone	Model Name	X5S
Temperature	25°C	Relative Humidity	54%
Test Voltage	AC 230V/50Hz		
Test Mode	Handfree		
Note	Adapter, Inject Internet Port, CDN T8		

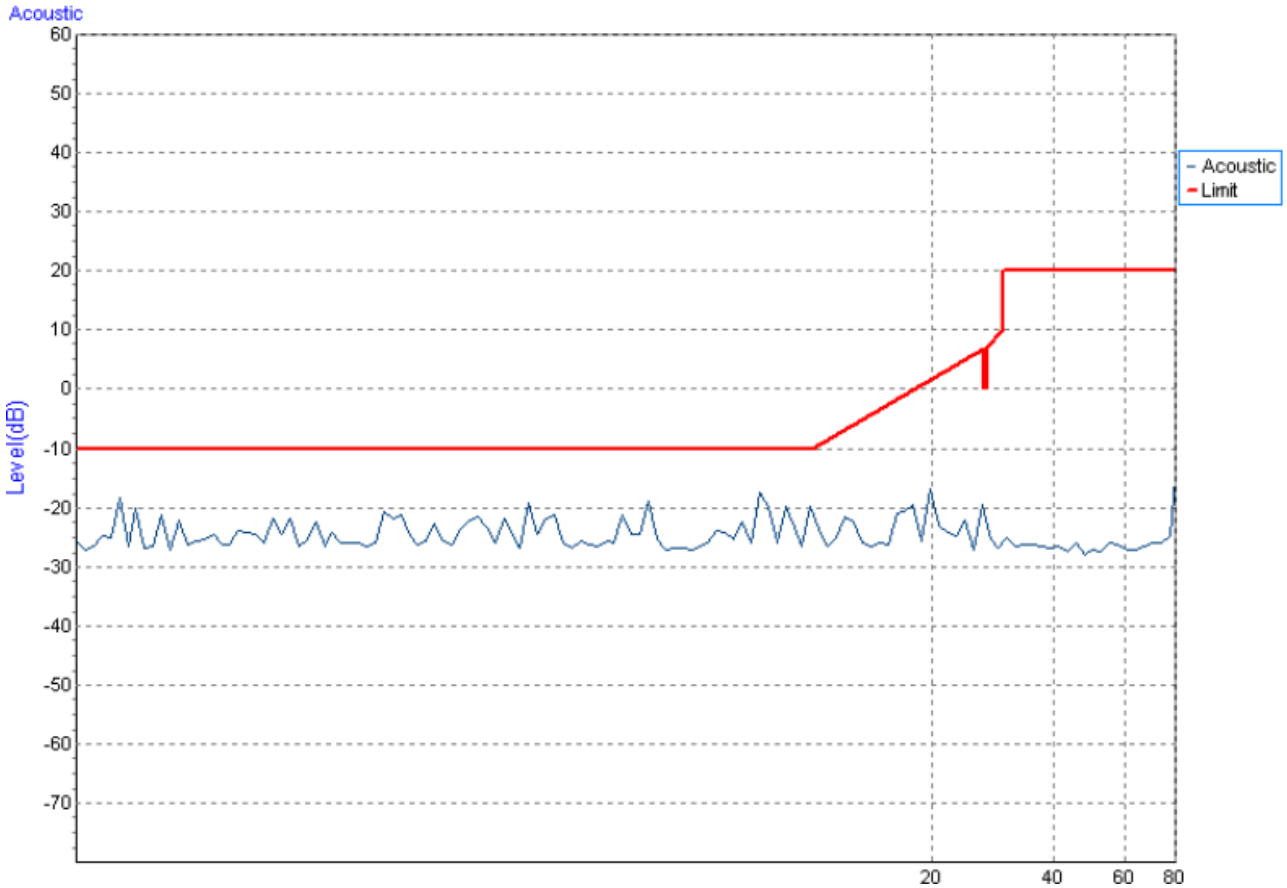

EUT	IP Phone	Model Name	X5S
Temperature	25°C	Relative Humidity	54%
Test Voltage	AC 230V/50Hz		
Test Mode	Handfree		
Note	Adapter CDN M2		

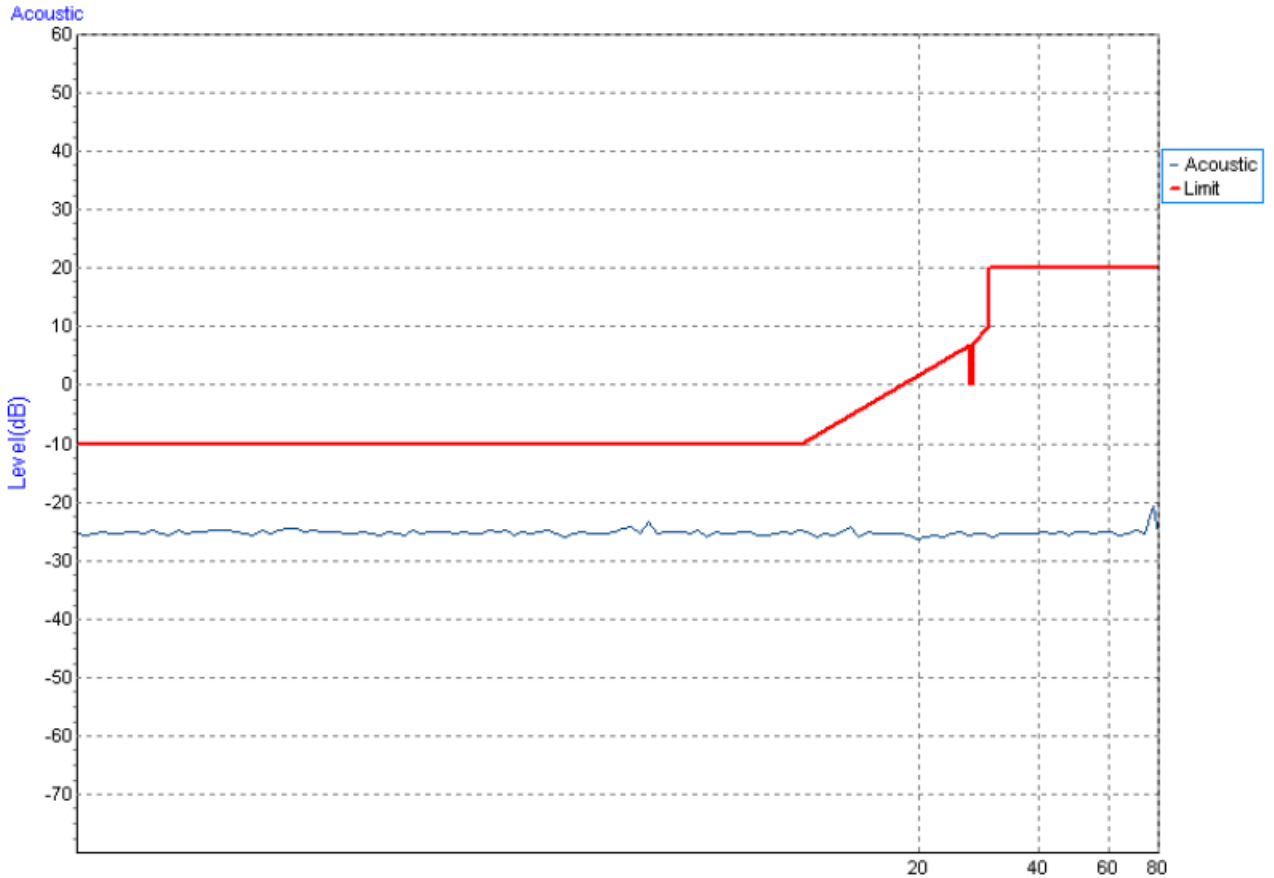

EUT	IP Phone	Model Name	X5S
Temperature	25°C	Relative Humidity	54%
Test Voltage	AC 230V/50Hz		
Test Mode	Handfree		
Note	Adapter, Inject PC Port, CDN T8		

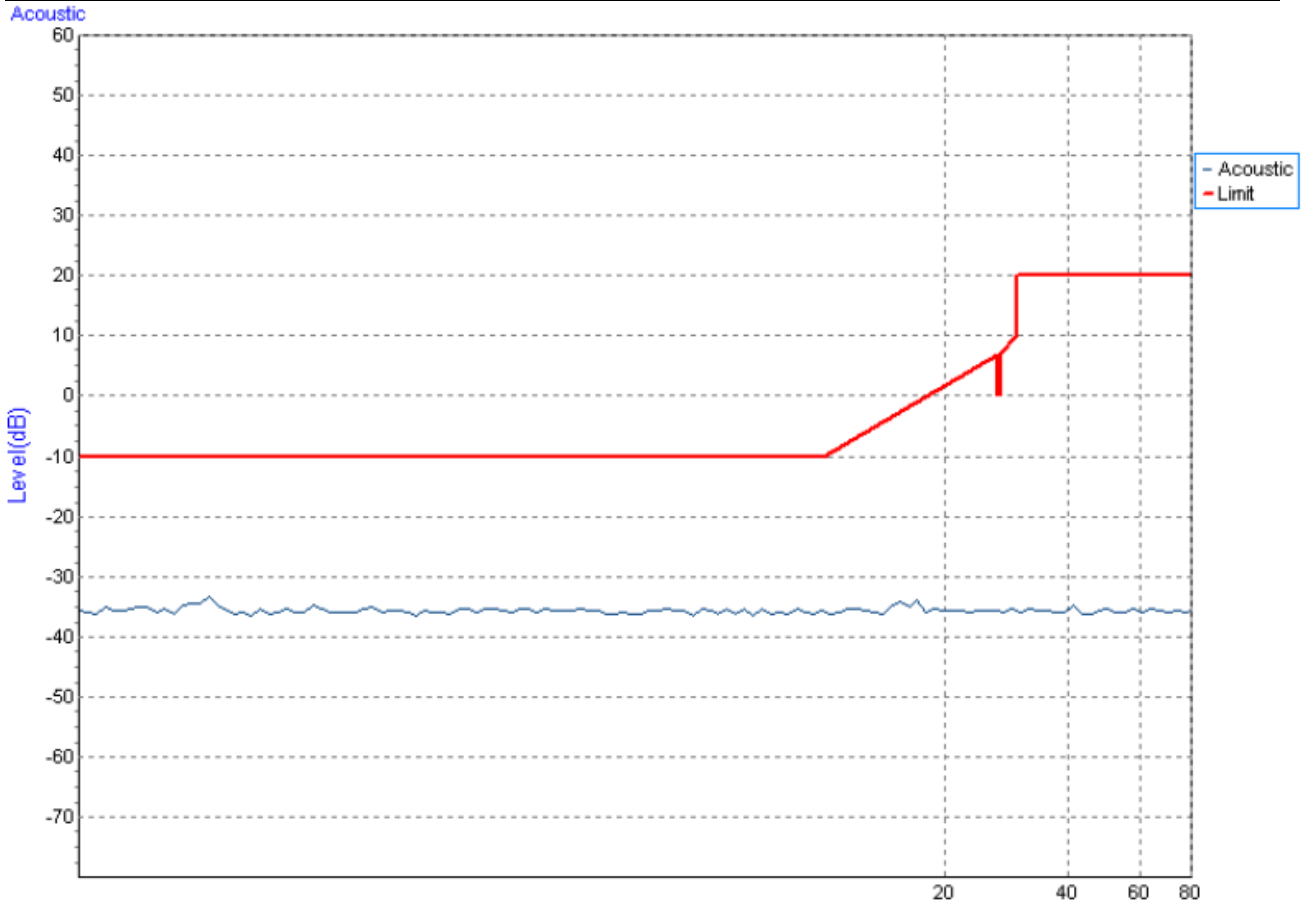

EUT	IP Phone	Model Name	X5S
Temperature	25°C	Relative Humidity	54%
Test Voltage	AC 230V/50Hz		
Test Mode	Handfree		
Note	PoE, Inject Internet Port, CDN T8		

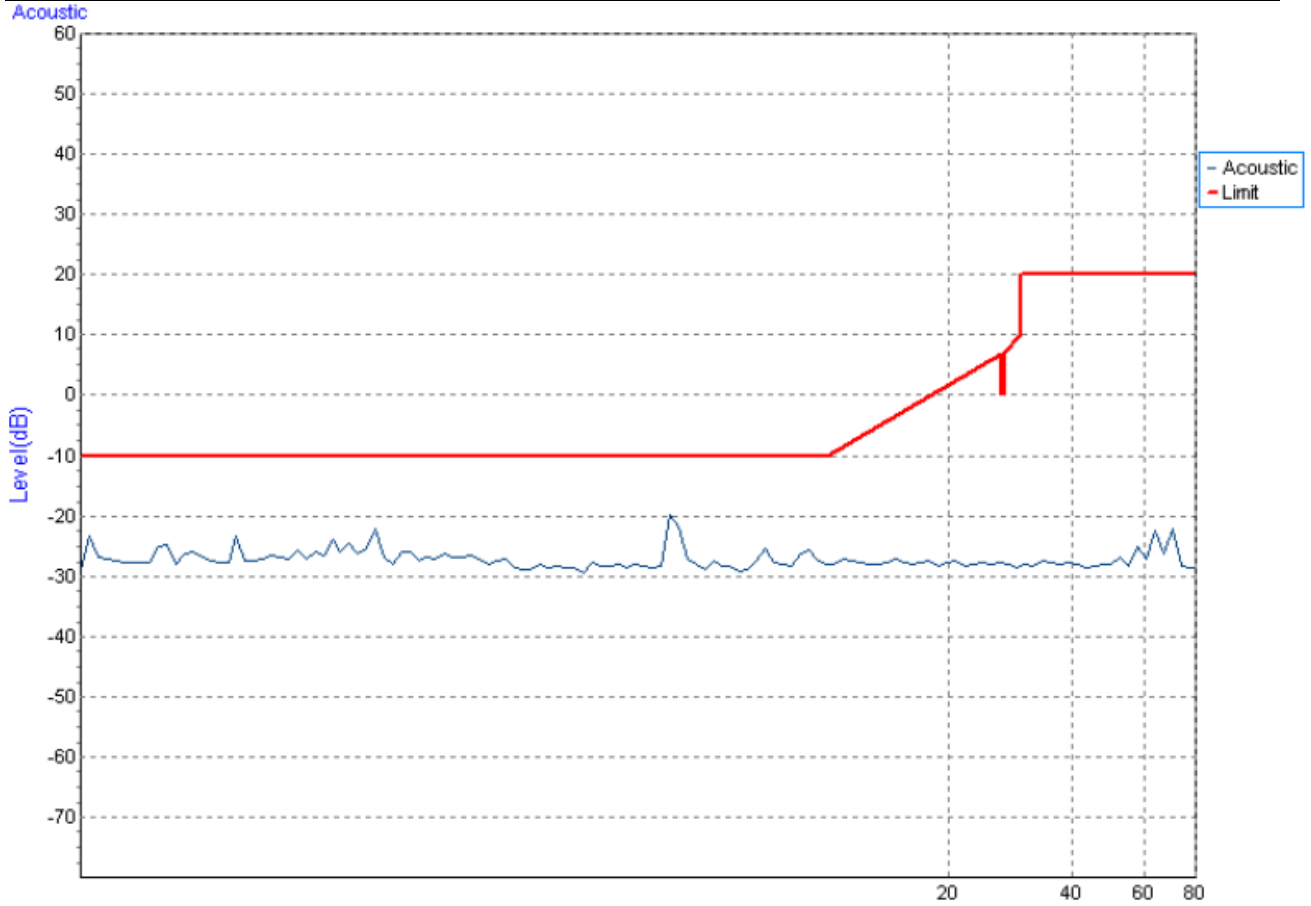

EUT	IP Phone	Model Name	X5S
Temperature	25°C	Relative Humidity	54%
Test Voltage	AC 230V/50Hz		
Test Mode	Handfree		
Note	PoE, Inject PC Port, CDN M2		

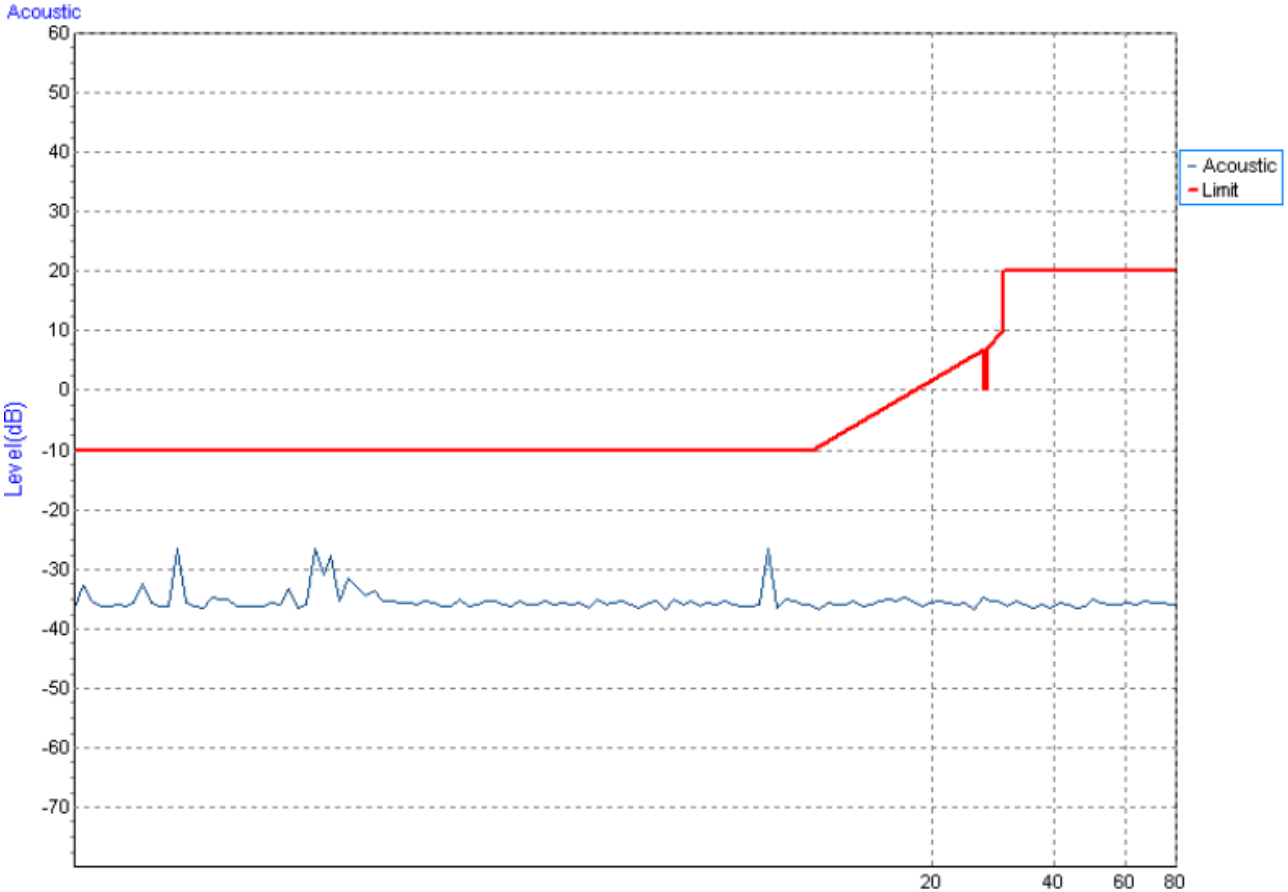

5.8 POWER FREQUENCY MAGNETIC FIELD IMMUNITY TEST (PFMF)

5.8.1 TEST SPECIFICATION

Basic Standard	EN 61000-4-8
Required Performance	A
Frequency Range	50/60 Hz
Field Strength	1 A/m
Observation Time	1 minute
Inductance Coil	Rectangular type, 1mx1m

5.8.2 MEASUREMENT INSTRUMENTS

Item	Kind of Equipment	Manufacturer	Type No.	Serial No.	Calibrated until
1	Magnetic Field test Generator	FCC	F-1000-4-8-G-125A	04032	Mar. 26, 2018
2	Magnetic Field immunity loop	Thermo KeyTek	F-1000-4-8/9/10-L-1M	04024	Mar. 26, 2018

Remark: "N/A" denotes no model name, no serial No. or no calibration specified.
All calibration period of equipment list is one year.

5.8.3 TEST PROCEDURE

The EUT and support equipment, are placed on a table that is 0.8 meter above a metal ground plane measured 1m*1m min. and 0.65mm thick min.

The other condition as following manner:

- a. The equipment cabinets shall be connected to the safety earth directly on the GRP via the earth terminal of the EUT.
- b. The cables supplied or recommended by the equipment manufacturer shall be used. 1 meter of all cables used shall be exposed to the magnetic field.

5.8.4 DEVIATION FROM TEST STANDARD

No deviation

5.8.5 TEST SETUP

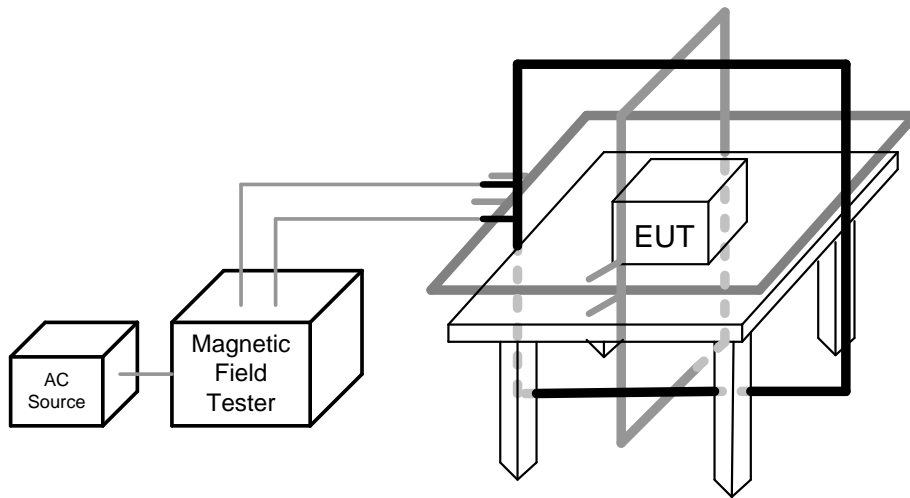

Note:

TABLE-TOP EQUIPMENT

The equipment shall be subjected to the test magnetic field by using the induction coil of standard dimension (1 m x 1 m). The induction coil shall then be rotated by 90 degrees in order to expose the EUT to the test field with different orientations.

FLOOR-STANDING EQUIPMENT

The equipment shall be subjected to the test magnetic field by using induction coils of suitable dimensions. The test shall be repeated by moving and shifting the induction coils, in order to test the whole volume of the EUT for each orthogonal direction. The test shall be repeated with the coil shifted to different positions along the side of the EUT, in steps corresponding to 50 percent of the shortest side of the coil. The induction coil shall then be rotated by 90 degrees in order to expose the EUT to the test field with different orientations.

5.8.6 TEST RESULTS

EUT	IP Phone	Model Name	X5S
Temperature	25°C	Relative Humidity	52%
Test Voltage	AC 230V/50Hz		
Test Mode	Handfree,Handset,Headphone		

50Hz

Test Mode	Test Level	Antenna aspect	Duration (s)	Criteria	Results	Judgment
Enclosure	1 A/m	X	60	A	A	PASS
Enclosure	1 A/m	Y	60	A	A	PASS
Enclosure	1 A/m	Z	60	A	A	PASS

60Hz

Test Mode	Test Level	Antenna aspect	Duration (s)	Criteria	Results	Judgment
Enclosure	1 A/m	X	60	A	A	PASS
Enclosure	1 A/m	Y	60	A	A	PASS
Enclosure	1 A/m	Z	60	A	A	PASS

Note:

- 1). N/A - denotes test is not applicable in this test report.
- 2) Criterion A: No observation of any performance degradation.
- 3) Criterion B: Some degradation of performance is observed but the equipment continues to operate as intended.
- 4) Criterion C: Loss of functionality, but self-recoverable by user, without loss of information or settings.

5.9 VOLTAGE DIPS, SHORT INTERRUPTIONS AND VOLTAGE VARIATIONS IMMUNITY TEST

5.9.1 TEST SPECIFICATION

Basic Standard	EN 61000-4-11
Required Performance	B (For >95% Voltage Dips) C (For 30% Voltage Dips) C (For >95% Voltage Interruptions)
Test Duration Time	Minimum three test events in sequence
Interval between Event	Minimum ten seconds
Phase Angle	0°/180°
Test Cycle	3 times

5.9.2 MEASUREMENT INSTRUMENTS

Item	Kind of Equipment	Manufacturer	Type No.	Serial No.	Calibrated until
1	THE MODULAR SOLUTION FOR 6 KV APPLICATIONS	Teseq	NSG 3060	1423	Sep. 04, 2017
2	Measurement Software	Teseq	Win 3000 Version 1.2.0	N/A	N/A

Remark: "N/A" denotes no model name, no serial No. or no calibration specified.

All calibration period of equipment list is one year.

5.9.3 TEST PROCEDURE

The EUT shall be tested for each selected combination of test levels and duration with a sequence of three dips/interruptions with intervals of 10 s minimum (between each test event). Each representative mode of operation shall be tested. Abrupt changes in supply voltage shall occur at zero crossings of the voltage waveform.

5.9.4 DEVIATION FROM TEST STANDARD

No deviation

5.9.5 TEST SETUP

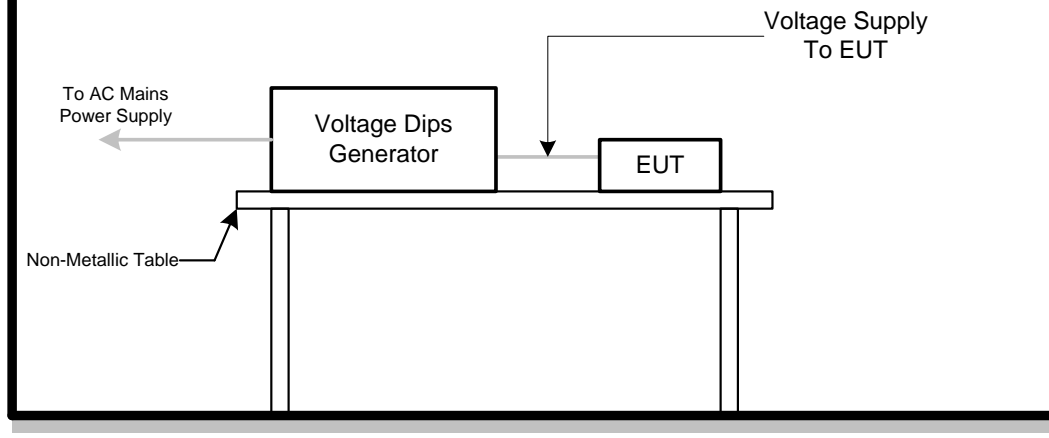

5.9.6 TEST RESULTS

EUT	IP Phone	Model Name	X5S
Temperature	25°C	Relative Humidity	52%
Test Voltage	AC 230V/50Hz		
Test Mode	Handfree,Handset,Headphone		

AC 100V/50Hz				
VoltageReduction	Periods	Criteria	Results	Judgment
Voltage dip > 95%	0.5	B	A	PASS
Voltage dip 30%	25	C	A	PASS
Interruption > 95%	250	C	C	PASS

AC 230V/50Hz				
VoltageReduction	Periods	Criteria	Results	Judgment
Voltage dip > 95%	0.5	B	A	PASS
Voltage dip 30%	25	C	A	PASS
Interruption > 95%	250	C	C	PASS

AC 240V/50Hz				
VoltageReduction	Periods	Criteria	Results	Judgment
Voltage dip > 95%	0.5	B	A	PASS
Voltage dip 30%	25	C	A	PASS
Interruption > 95%	250	C	C	PASS

Note:

- 1). N/A - denotes test is not applicable in this test report.
- 2) Criterion A: No observation of any performance degradation.
- 3) Criterion B: Some degradation of performance is observed but the equipment continues to operate as intended.
- 4) Criterion C: Loss of functionality, but self-recoverable by user, without loss of information or settings.

6. EUT TEST PHOTO

Radiated emissions up to 1 GHz - AC

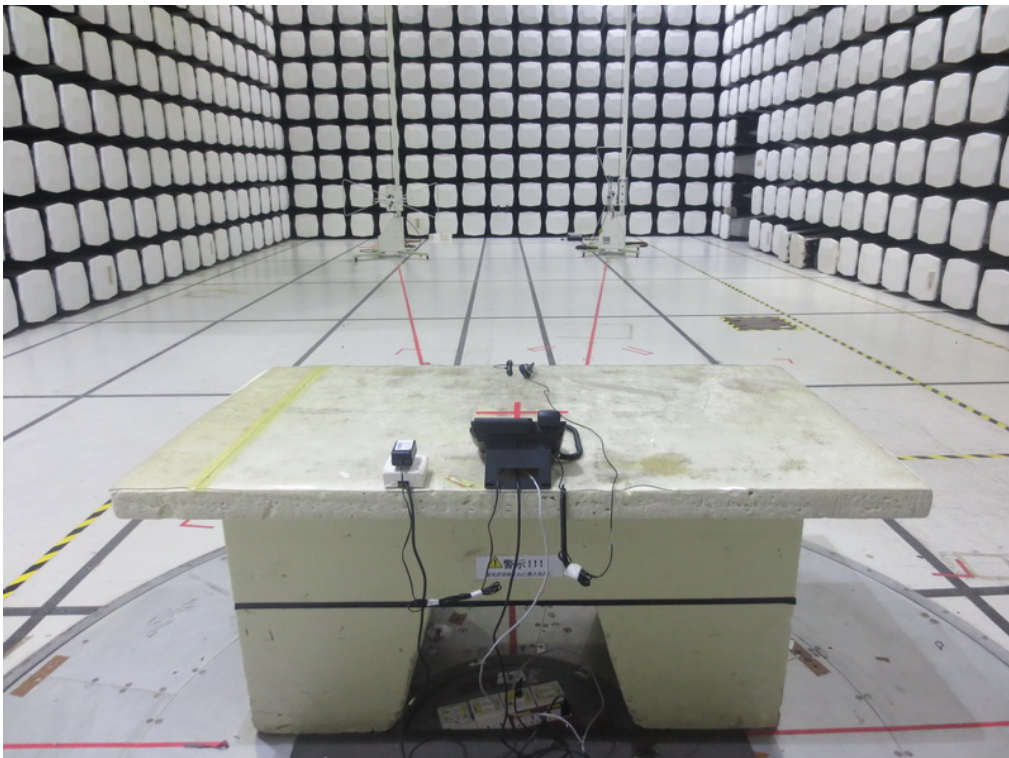
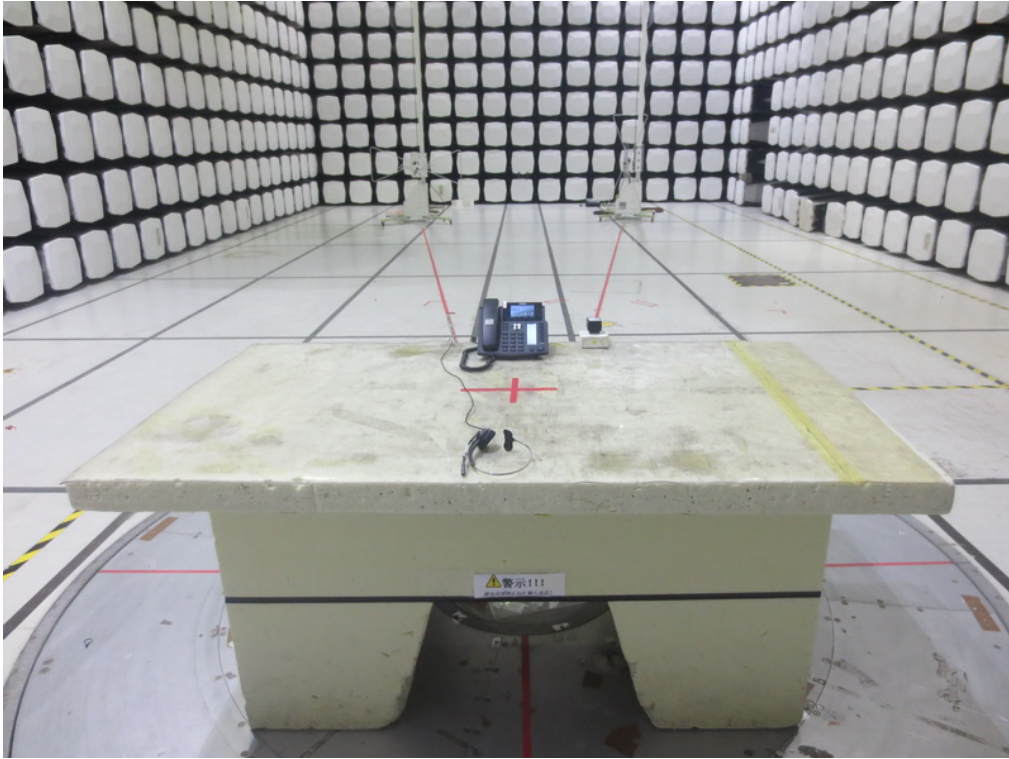

Radiated emissions up to 1 GHz - PoE

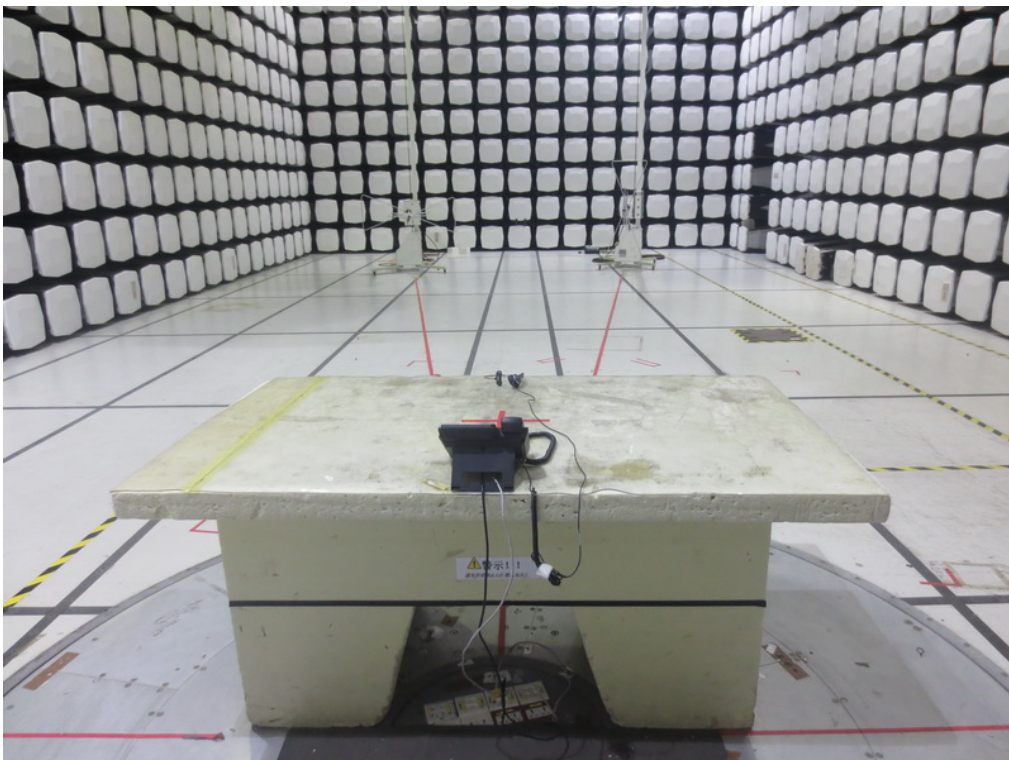
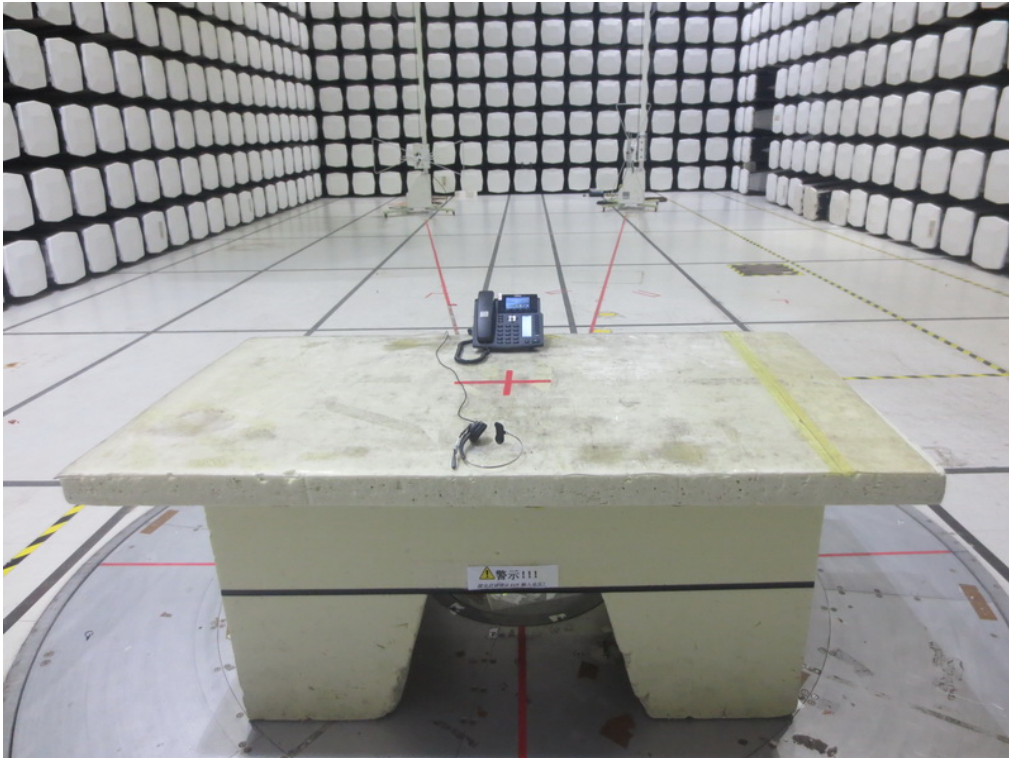

Radiated emissions above 1 GHz - AC

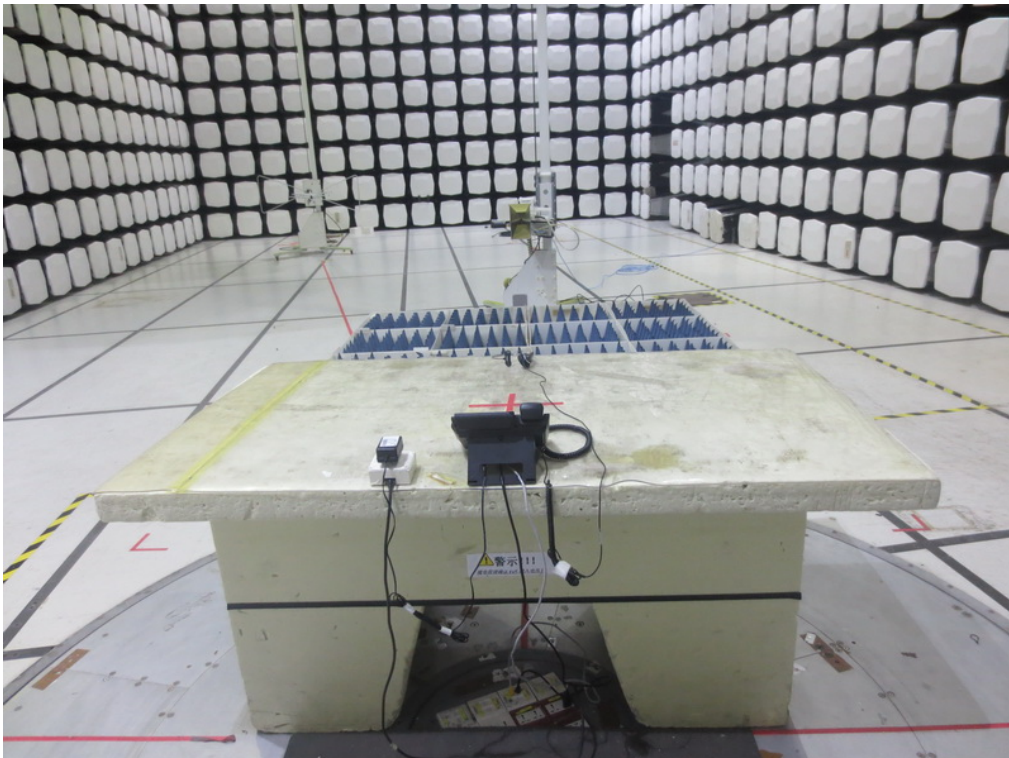
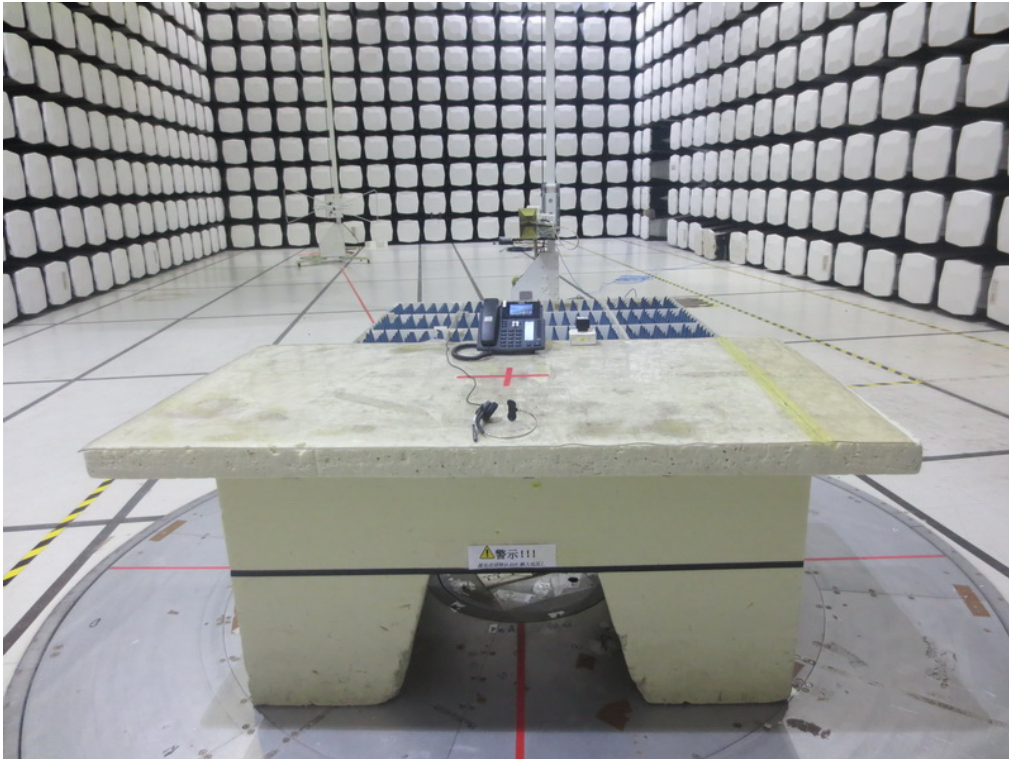

Radiated emissions above 1 GHz - PoE

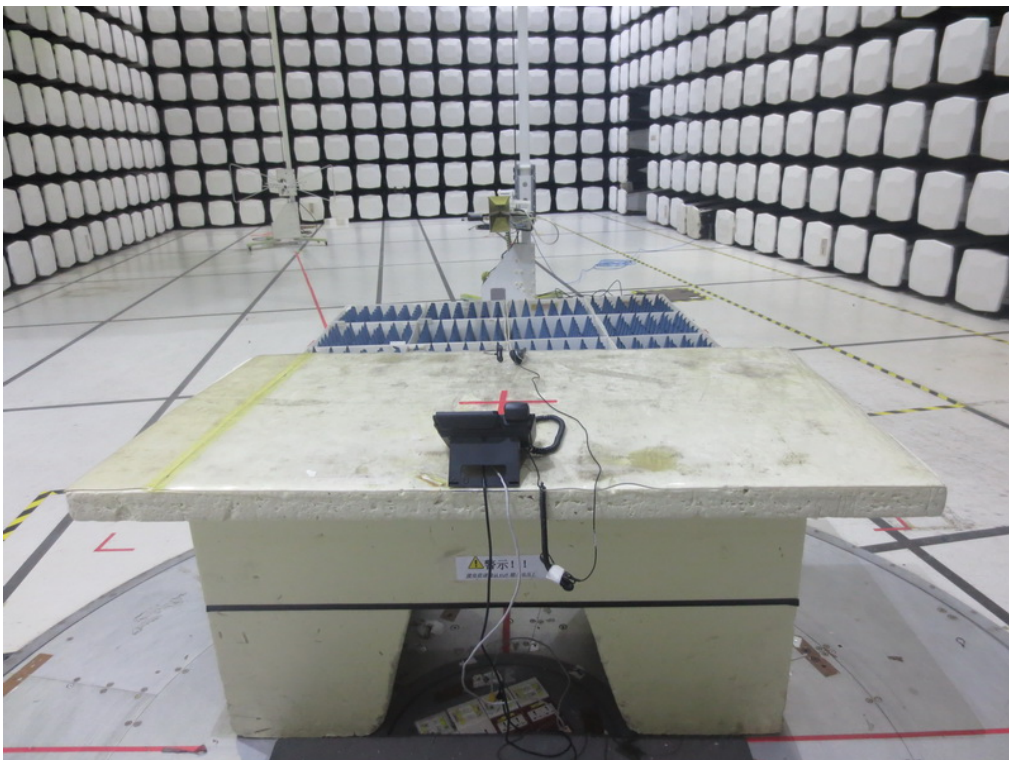
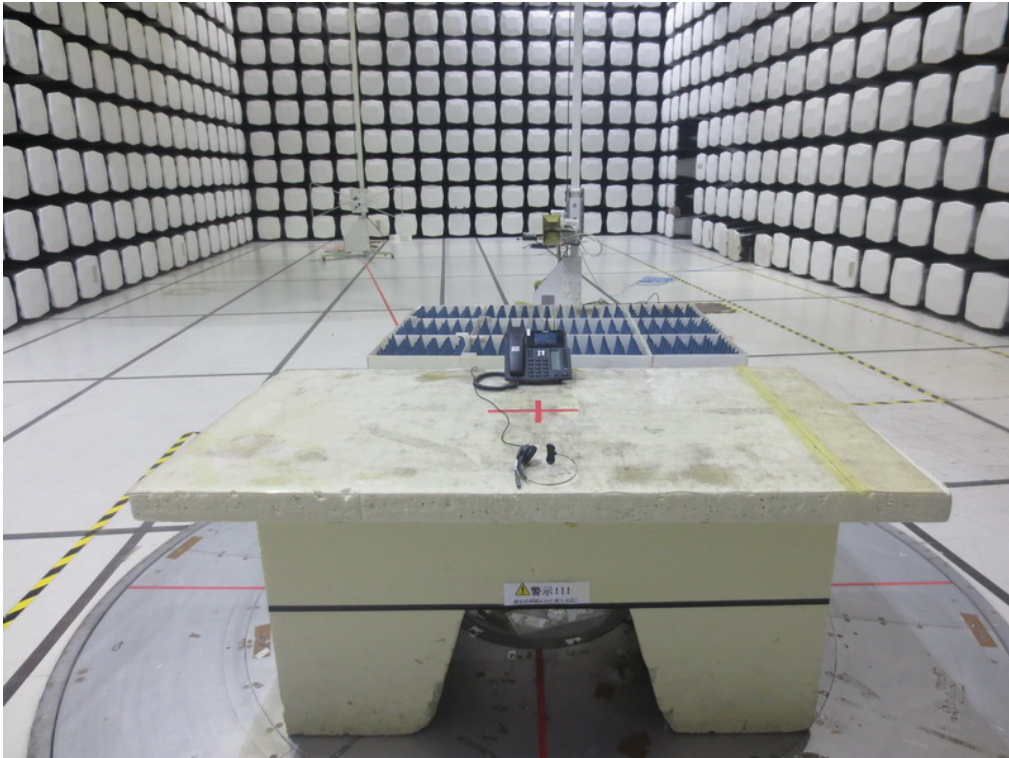

Conducted emissions AC mains power port - AC

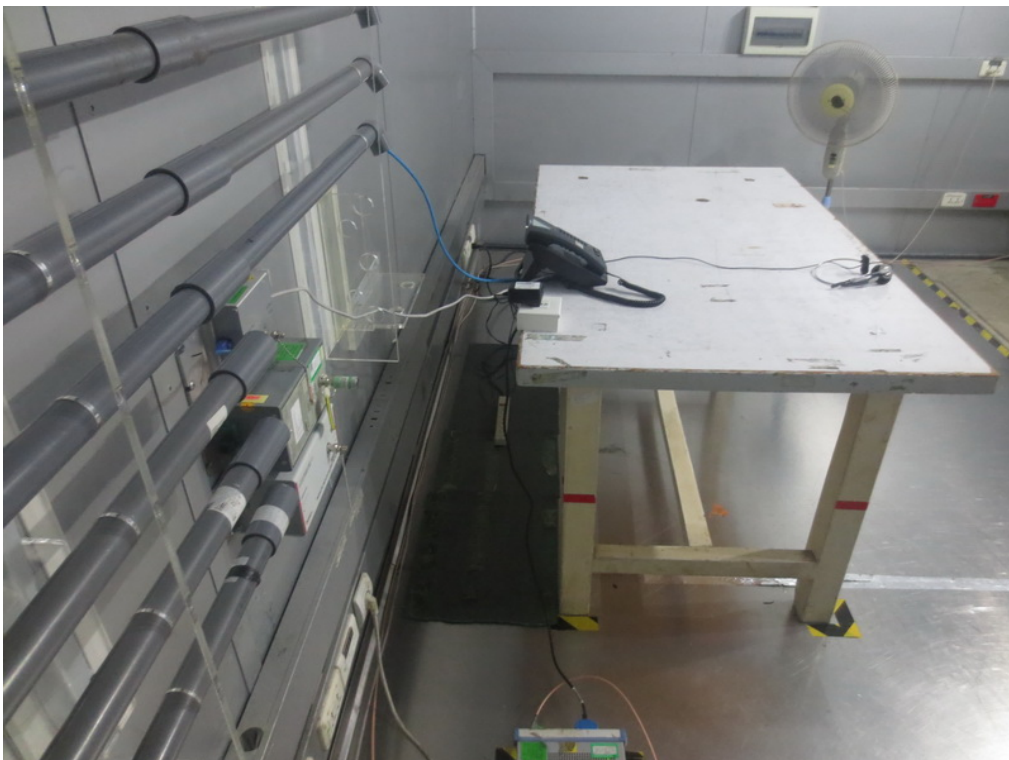
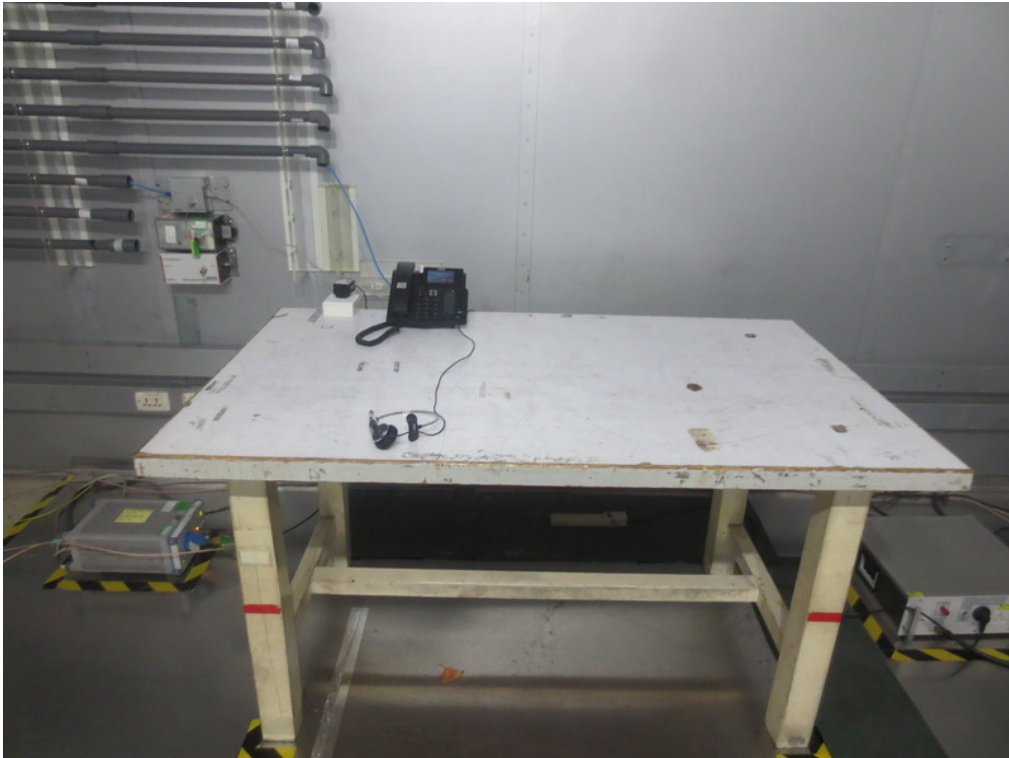

Asymmetric mode conducted emissions_AAN - AC

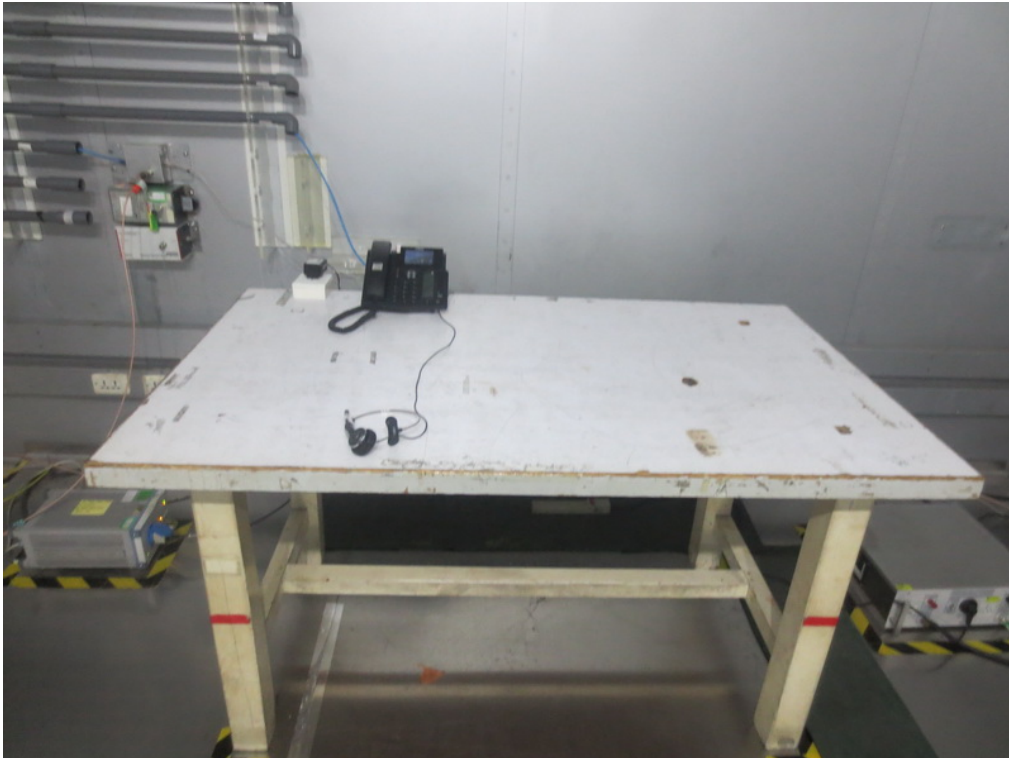

Asymmetric mode conducted emissions_AAN - PoE

