



EMC COMPLIANCE TEST REPORT

for

GATEWAY

Trade Name : N/A
Model Number : G100S,G200S
Serial Number : N/A
Report Number : PZD1606690-E
Date : July 1, 2016
Regulations : See below

Standards	Results (Pass/Fail)
EN 55022:2010;	PASS
EN 61000-3-2: 2014;	PASS
EN 61000-3-3: 2013;	PASS
EN 55024:2010;	PASS
EN 61000-4-2: 2009;	PASS
EN 61000-4-3: 2006+A1:2008+A2:2010;	PASS
EN 61000-4-4: 2012;	PASS
EN 61000-4-5: 2014;	PASS
EN 61000-4-6: 2014;	PASS
EN 61000-4-11: 2004	PASS

Prepared for:

**FANVIL TECHNOLOGY CO., LTD.
LEVEL 3, BLOCK A, GAOXINQI BUILDING,
ANHUA INDUSTRIAL PARK, QIANJIN 1 ROAD, 35TH DISTRICT,
BAO'AN, SHENZHEN, 518101 P.R. CHINA.**

Prepared by:

**SHENZHEN PZD TECHNOLOGY CO.,LTD.
10F,EAST TOWER, XINGHUA BUILDING,NO.2018,SHENNAN ROAD,
FUTIAN DISTRICT,SHENZHEN,GUANGDONG,CHINA
TEL: 86-755-6163-6090
FAX: 86-755-6163-6091**

TABLE OF CONTENTS

1	VERIFICATION OF COMPLIANCE.....	3
2	SYSTEM DESCRIPTION	4
3	PRODUCT INFORMATION.....	5
4	SUPPORT EQUIPMENT	6
5	TEST FACILITY.....	7
6	TEST EQUIPMENT LIST.....	8
	SECTION 1 LINE CONDUCTED EMISSION	10
	MEASUREMENT PROCEDURE.....	10
	BLOCK DIAGRAM OF TEST SETUP	16
	SUMMARY DATA.....	17
	SECTION 2 EN 61000-3-2 & EN 61000-3-3	21
	SECTION 3 EN 61000-4-2 (ELECTROSTATIC DISCHARGE)	23
	SECTION 4 EN 61000-4-3 (RADIATED ELECTROMAGNETIC FIELD)	26
	SECTION 5 EN 61000-4-4 (FAST TRANSIENTS/BURST)	28
	SECTION 6 EN 61000-4-5 (SURGE IMMUNITY)	30
	SECTION 7 EN 61000-4-6(CONDUCTED DISTRBANCE/INDUCED BY	32
	SECTION 8 EN 61000-4-11 (VOLTAGE DIPS, SHORT INTERRUPTIONS.....	34
	APPENDIX 1	36
	PHOTOGRAPHS OF TEST SETUP	36
	APPENDIX 2	41
	PHOTOGRAPHS OF EUT.....	41

1 VERIFICATION OF COMPLIANCE

Equipment Under Test: GATEWAY

Trade Name: N/A

Model Number: G100S,G200S

Serial Number: N/A

EUT Powered during test: DC12V input from ADAPTER POWERED 230VAC

Applicant: FANVIL TECHNOLOGY CO., LTD.
LEVEL 3, BLOCK A, GAOXINQI BUILDING,
ANHUA INDUSTRIAL PARK, QIANJIN 1 ROAD, 35TH DISTRICT,
BAO'AN, SHENZHEN, 518101 P.R. CHINA.

Manufacturer: FANVIL TECHNOLOGY CO., LTD.
LEVEL 3, BLOCK A, GAOXINQI BUILDING,
ANHUA INDUSTRIAL PARK, QIANJIN 1 ROAD, 35TH DISTRICT,
BAO'AN, SHENZHEN, 518101 P.R. CHINA.

Type of Test: EMC Directive 2014/30/EU for CE Marking

Technical Standards: EN 55022:2010;
EN 61000-3-2: 2014;
EN 61000-3-3: 2013;
EN 55024:2010;
EN 61000-4-2: 2009;
EN 61000-4-3: 2006+A1:2008+A2:2010;
EN 61000-4-4: 2012;
EN 61000-4-5: 2014;
EN 61000-4-6: 2014;
EN 61000-4-11: 2004

File Number: PZD1606690-E

Date of test: June 20, 2016

Deviation: None

Condition of Test Sample: Normal

The above equipment was tested by Shenzhen PZD Technology Co.,Ltd. for compliance with the requirements set forth in Directive 2014/30/EU and the Technical Standards mentioned above. This said equipment in the configuration described in this report shows the maximum emission levels emanating from equipment and the level of the immunity endurance of the equipment are within the compliance requirements.

The test results of this report relate only to the tested sample identified in this report.

Approved by Authorized Signatory:

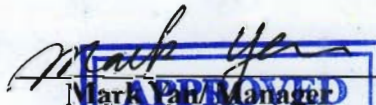
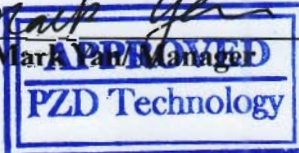
Mark Pan, Manager

2 SYSTEM DESCRIPTION

EUT Test Program:

NORMAL MODE

1. Set up EUT and relative support equipments.
2. Then ping the IP from PC to EUT.
3. Keep the program running throughout the test.

3 PRODUCT INFORMATION

Housing Type: Plastic
EUT Power Rating: DC 12V from adapter
Adapter Manufacturer/Model No: Input:100-240VAC 50-60Hz
Output:12VDC,0.6A
OSC Frequency 25MHz

I/O Port of EUT:

	I/O Port Type	Q'TY	Tested with
1)	RJ45 port	2	2
2)	RJ11 port	1	1
3)	DC INLET	1	1

Difference between model numbers as below:

N/A

4 SUPPORT EQUIPMENT

No.	Equipment	Model #	Serial #	Trade Name	Data Cable	Power Cord
1)	PC	---	N/A	LENOVO	N/A	---
2)	TELEPHONE	---	---	---	---	---

****Note:** All the above equipment/cables were placed in worse case positions to maximize emission signals during emission test.

Grounding: Grounding was in accordance with the manufacturer's requirements and conditions for the intended use.

5 TEST FACILITY

- Location:** Bldg. 69, Majialong Industrial Zone, Nanshan District, Shenzhen Guangdong, China
- Description:** There are one 3 chamber and one line conducted labs for final test. The 3m chamber and the Line Conducted labs are constructed and calibrated to meet the FCC requirements in documents ANSI C63.4 and CISPR 22/EN 55022 requirements.
- Site Accreditation:** Accredited by FCC, April 17, 2013
The Certificate Registration Number. is 709623
Accredited by Industry Canada, November 15, 2013
The Certificate Registration Number. is 46405-4480
Accredited by CNAS , October 29, 2013
The Certificate Registration Number. is L2291
Accredited by VCCI , March 18, 2014
The Certificate Registration Number. is R-2777
- Instrument Tolerance:** All measuring equipment is in accord with ANSI C63.4 and CISPR 22 requirements that meet industry regulatory agency and accreditation agency requirement.
- Ground Plane:** Two conductive reference ground planes were used during the Line Conducted Emission, one in vertical and the other in horizontal. The dimensions of these ground planes are as below. The vertical ground plane was placed distancing 40 cm to the rear of the wooden test table on where the EUT and the support equipment were placed during test. The horizontal ground plane projected 50 cm beyond the footprint of the EUT system and distanced 80 cm to the wooden test table. For Radiated Emission Test, one horizontal conductive ground plane extended at least 1m beyond the periphery of the EUT and the largest measuring antenna, and covered the entire area between the EUT and the antenna. It has no holes or gaps having longitudinal dimensions larger than one-tenth of a wavelength at the highest frequency of measurement up to 1GHz.

6 TEST EQUIPMENT LIST

Instrumentation: The equipment conforms to the CISPR 16-1 / ANSI C63.2-2009 Specifications for Electromagnetic Interference and Field Strength Instrumentation from 10kHz to 1.0 GHz or above.

Equipment used during the tests:

For Conducted Emission Test

Item	Equipment	Manufacturer	Model No.	Serial No.	Last Cal.	Cal. Interval
1	Test Receiver	Rohde & Schwarz	ESCS30	828985/018	May 12, 2016	1 Year
2	L.I.S.N.	Rohde & Schwarz	ESH2-Z5	834549/005	May 12, 2016	1 Year
3	RF Cable	FUJIAKURA	3D-2W	No.1	May 12, 2016	1 Year
4	Pulse Limiter	Rohde & Schwarz	ESH3-Z2	100006	May 12, 2016	1 Year
5	Coaxial Switch	Anritsu	MP59B	M20531	May 12, 2016	1 Year

For Radiation Emission Test

Item	Equipment	Manufacturer	Model No.	Serial No.	Last Cal.	Cal. Interval
1	Spectrum Analyzer	ADVANTENT	R3132	N/A	May 12, 2016	1 Year
2	LISN(EUT)	EMCO	3825/2	1371	May 12, 2016	1 Year
3	LISN	EMCO	3825/2	8901-1459	May 12, 2016	1 Year
4	Spectrum Analyzer	ADVANTENT	R3132	N/A	May 12, 2016	1 Year

For Harmonic & Flicker Test

Item	Equipment	Manufacturer	Model No.	Serial No.	Last Cal.	Cal. Interval
1.	Power Frequency System	HAEFELY	PHF555	080419-03	May 12, 2016	1Year
2.	PC	N/A	P2L97	N/A	N/A	N/A

For Electrostatic Discharge Immunity Test

Item	Equipment	Manufacturer	Model No.	Serial No.	Last Cal.	Cal. Interval
1.	ESD Tester	HAEFELY	PESD1600	H708159	May 12, 2016	1 Year

For RF Strength Susceptibility Test

Item	Equipment	Manufacturer	Model No.	Serial No.	Last Cal.	Cal. Interval
1.	Signal Generator	Maconi	2022D	119246/003	May 12, 2016	1 Year
2.	Power Amplifier	M2S	A00181/ 1000	9801-112	May 12, 2016	1 Year
3.	Power Amplifier	M2S	AC8113/ 800-250A	9801-179	May 12, 2016	1 Year
4.	Power Antenna	SCHAFFNER	CBL6140A	1204	May 12, 2016	1 Year

For Electrical Fast Transient /Burst Immunity Test

Item	Equipment	Manufacturer	Model No.	Serial No.	Last Cal.	Cal. Interval
1.	Burst Tester	HAEFELY	PEFT4010	080981-16	May 12, 2016	1 Year
2	Coupling Clamp	HAEFELY	IP-4A	147147	May 12, 2016	1 Year

For Surge Immunity Test

Item	Equipment	Manufacturer	Model No.	Serial No.	Last Cal.	Cal. Interval
1.	Surge Tester	HAEFELY	PSURGE4.1	080107-04	May 12, 2016	1 Year

For Injected Current Susceptibility Test

Item	Equipment	Manufacturer	Model No.	Serial No.	Last Cal.	Cal. Interval
1.	Simulator	EMTEST	CWS500C	0900-12	May 12, 2016	1 Year
2.	CDN	EMTEST	CDN-M2	5100100100	May 12, 2016	1 Year
3.	CDN	EMTEST	CDN-M3	0900-11	May 12, 2016	1 Year
4	Injection Clamp	EMTEST	F-2031-23MM	368	May 12, 2016	1 Year
5	Attenuator	EMTEST	ATT6	0010222A	May 12, 2016	1 Year

For Magnetic Field Immunity Test

Item	Equipment	Manufacturer	Model No.	Serial No.	Last Cal.	Cal. Interval
1	Magnetic Field Tester	HAEFELY	MAG100	250040.1	May 12, 2016	1 Year
2	AC Transformer	CHOKUN	TDGC2J-5	N/A	N/A	N/A

For Voltage Dips and Interruptions Test

Item	Equipment	Manufacturer	Model No.	Serial No.	Last Cal.	Cal. Interval
1.	Dips Tester	HAEFELY	Pline1610	083732-18	May 12, 2016	1 Year

The calibrations of the measuring instruments, including any accessories that may effect such calibration, are checked frequently to assure their accuracy. Adjustments are made and correction factors applied in accordance with instructions contained in the manual for the measuring instrument.

SECTION 1 LINE CONDUCTED, COMMON MODE CONDUCTED EMISSION FOR TELECOMMUNICATION PORTS AND RADIATED EMISSION MEASUREMENT PROCEDURE (PRELIMINARY LINE CONDUCTED EMISSION TEST)

- 1) The equipment was set up as per the test configuration to simulate typical actual usage per the user's manual. When the EUT is a tabletop system, a wooden table with a height of 0.8 meters is used and is placed on the ground plane as per EN55022 (see Test Facility for the dimensions of the ground plane used). When the EUT is a floor-standing equipment, it is placed on the ground plane which has a 3-12 mm non-conductive covering to insulate the EUT from the ground plane.
- 2) Support equipment, if needed, was placed as per EN55022.
- 3) All I/O cables were positioned to simulate typical actual usage as per EN55022.
- 4) The EUT received DC power from a adaptor received power through a Line Impedance Stabilization Network (LISN) which supplied power source and was grounded to the ground plane.
- 5) All support equipments received power from a second LISN supplying power of AC 230V/50Hz, if any.
- 6) The EUT test program was started. Emissions were measured on each current carrying line of the EUT using a spectrum Analyzer / Receiver connected to the LISN powering the EUT. The LISN has two monitoring points: Line 1 (Hot Side) and Line 2 (Neutral Side). Two scans were taken: one with Line 1 connected to Analyzer / Receiver and Line 2 connected to a 50 ohm load; the second scan had Line 1 connected to a 50 ohm load and Line 2 connected to the Analyzer / Receiver.
- 7) Analyzer / Receiver scanned from 150kHz to 30MHz for emissions in each of the test modes.
- 8) During the above scans, the emissions were maximized by cable manipulation.
- 9) The following test mode(s) were scanned during the preliminary test:

Preliminary Conducted Emission Test			
Frequency Range Investigated		150KHz TO 30 MHz	
Mode of operation	Date	Data Report No.	Worst Mode
Normal	2016-06-20	G100S_0(L, N)	<input checked="" type="checkbox"/>

Then, the EUT configuration and cable configuration of the above highest emission level were recorded for reference of final testing.

MEASUREMENT PROCEDURE (FINAL LINE CONDUCTED EMISSION TEST)

- 1) EUT and support equipment was set up on the test bench as per step 9 of the preliminary test.
- 2) A scan was taken on both power lines, Line 1 and Line 2, recording at least the six highest emissions. Emission frequency and amplitude were recorded into a computer in which correction factors were used to calculate the emission level and compare reading to the applicable limit. If EUT emission level was less -2dB to the A.V. limit in Peak mode, then the emission signal was re-checked using an Average detector.
- 3) The test data of the worst case condition(s) was reported on the Summary Data page.

Data Sample:

Freq. MHz	Peak Raw dBuV	Q.P. Raw dBuV	Average Raw dBuV	Q.P. Limit dBuV	Average Limit dBuV	Q.P. Margin dB	Average Margin dB	Note
X.XXX	43.90	---	---	56.00	46.00	---	-2.10	L 1

Freq.	= Emission frequency in MHz
Raw dBuV	= Uncorrected Analyzer/Receiver reading
Limit dBuV	= Limit stated in standard
Margin dB	= Reading in reference to limit
Note	= Current carrying line of reading
“---“	= The emission level complied with the Average limits, with at least 2 dB margin, so no further recheck.

LINE CONDUCTED EMISSION LIMIT

Frequency	Maximum RF Line Voltage	
	Q.P.	AVERAGE
150kHz-500kHz	66-56dBuV	56-46dBuV
500kHz-5MHz	56dBuV	46dBuV
5MHz-30MHz	60dBuV	50dBuV

****Note:** The lower limit shall apply at the transition frequency.

EN 55022 MEASUREMENT PROCEDURE

(TEST PROCEDURE OF COMMON MODE CONDUCTED EMISSION FOR TELECOMMUNICATION PORTS)

- 1) Selecting ISN for unscreened cable or a current probe for screened cable to take measurement.
- 2) The port of the EUT was connected to the remote side support equipment through the ISN/Current Probe and communication in normal condition.
- 3) Making a overall range scan by using the test receiver controlled by controller and record at least six highest emissions for showing in the test report.
- 4) Emission frequency and amplitude were recorded into a computer in which correction factors were used to calculate the emission level and compare reading to the applicable limit.
- 5) In case of measuring on the screened cable, the current limit shall be applied, otherwise the voltage limit should be applied.
- 6) The following test mode was scanned during the preliminary test:

COMMON MODE Conducted Emission Test(TELECOMMUNICATION PORTS)			
Frequency Range Investigated		150KHz TO 30 MHz	
Mode of operation	Date	Data Report No.	Worst Mode
Normal	2016-06-20	G100S _0	<input checked="" type="checkbox"/>

Then, the EUT configuration and cable configuration of the above highest emission level were recorded for reference of final testing.

Data Sample:

FREQ MHz	PEAK Raw dBuA	QP Raw dBuA	AVG Raw dBuA	QP Limit dBuA	AVG Limit dBuA	QP Margin dB	AVG Margin dB
xx.xxx	61.02			74.00	64.00		-3.08

Freq. = Emission frequency in MHz

Raw dBuV = Analyzer/Receiver reading + Insertion Loss

Limit dBuV = Limit stated in standard

Margin dB = Reading in reference to limit

Note = Current carrying line of reading

“---“ = The emission level complied with the Average limits, at least 2dB margin limits, so no recheck anymore.

COMMON MODE CONDUCTED EMISSION LIMIT
(TELECOMMUNICATION PORTS)

Frequency	Current Limits (dBuA)	
	Quasi-Peak	AVERAGE
150kHz-500kHz	84-74	74-64
500kHz-30MHz	74	64

****Note:** The lower limit shall apply at the transition frequency.

MEASUREMENT PROCEDURE

(PRELIMINARY RADIATED EMISSION TEST)

- 1) The equipment was set up as per the test configuration to simulate typical actual usage per the user's manual. When the EUT is a tabletop system, a wooden turntable with a height of 0.8 meters is used which is placed on the ground plane as per EN 55022 (see Test Facility for the dimensions of the ground plane used). When the EUT is a floor-standing equipment, it is placed on the ground plane which has a 3-12 mm non-conductive covering to insulate the EUT from the ground plane.
- 2) Support equipment, if needed, was placed as per EN 55022.
- 3) All I/O cables were positioned to simulate typical actual usage as per EN 55022.
- 4) The EUT received from a adapter. Run cpoytest program and other suitable program. All support equipments received AC 230V/50Hz power from socket under the turntable, if any.
- 5) The antenna was placed at 3 meter away from the EUT as stated in EN 55022 . The antenna connected to the Analyzer via a cable and at times a pre-amplifier would be used.
- 6) The Analyzer / Receiver quickly scanned from 30MHz to 1000MHz. The EUT test program was started. Emissions were scanned and measured rotating the EUT to 360 degrees and positioning the antenna 1 to 4 meters above the ground plane, in both the vertical and the horizontal polarization, to maximize the emission reading level.
- 7) The following test mode(s) were scanned during the preliminary test:

Preliminary Radiated Emission Test			
Frequency Range Investigated		30 MHz TO 1000 MHz	
Mode of operation	Date	Data Report No.	Worst Mode
Normal	2016-06-20	G100S_0(H, V)	<input checked="" type="checkbox"/>

Then, the EUT and cable configuration, antenna position, polarization and turntable position of the above highest emission level were recorded for final testing.

MEASUREMENT PROCEDURE (FINAL RADIATED EMISSION TEST)

- 1) EUT and support equipment were set up on the turntable as per step 7 of the preliminary test.
- 2) The Analyzer / Receiver scanned from 30MHz to 1000MHz. Emissions were scanned and measured rotating the EUT to 360 degrees, varying cable placement and positioning the antenna 1 to 4 meters above the ground plane, in both the vertical and the horizontal polarization, to maximize the emission reading level.
- 3) Recorded at least the six highest emissions. Emission frequency, amplitude, antenna position, polarization and turntable position were recorded into a computer in which correction factors were used to calculate the emission level and compare reading to the applicable limit and Q.P./Peak reading is presented.
- 4) The test data of the worst case condition(s) was reported on the Summary Data page.

Data Sample:

Freq. (MHz)	Raw Data (dBuV/m)	Corr. Factor (dB)	Emiss. Level (dBuV/m)	Limits (dB)	Margin P/Q	Reading Type
xxx.xxx	24.03	22.25	36.28	40.00	-3.72	P

- Freq. = Emission frequency in MHz
- Raw Data (dBuV/m) = Uncorrected Analyzer / Receiver reading
- Corr. Factor (dB) = Correction factors of antenna factor and cable loss
- Emiss. Level = Raw reading converted to dBuV/m and CF added
- Limit dBuV/m = Limit stated in standard
- Margin dB = Reading in reference to limit
- P =Peak Reading
- Q =Quasi-peak

RADIATED EMISSION LIMIT

Frequency (MHz)	Distance (m)	Maximum Field Strength Limit (dBuV/m/ Q.P.)
30-230	3	40
230-1000	3	47

****Note:** The lower limit shall apply at the transition frequency.

BLOCK DIAGRAM OF TEST SETUP

EUT : GATEWAY
Trade Name : N/A
Model Number : G100S

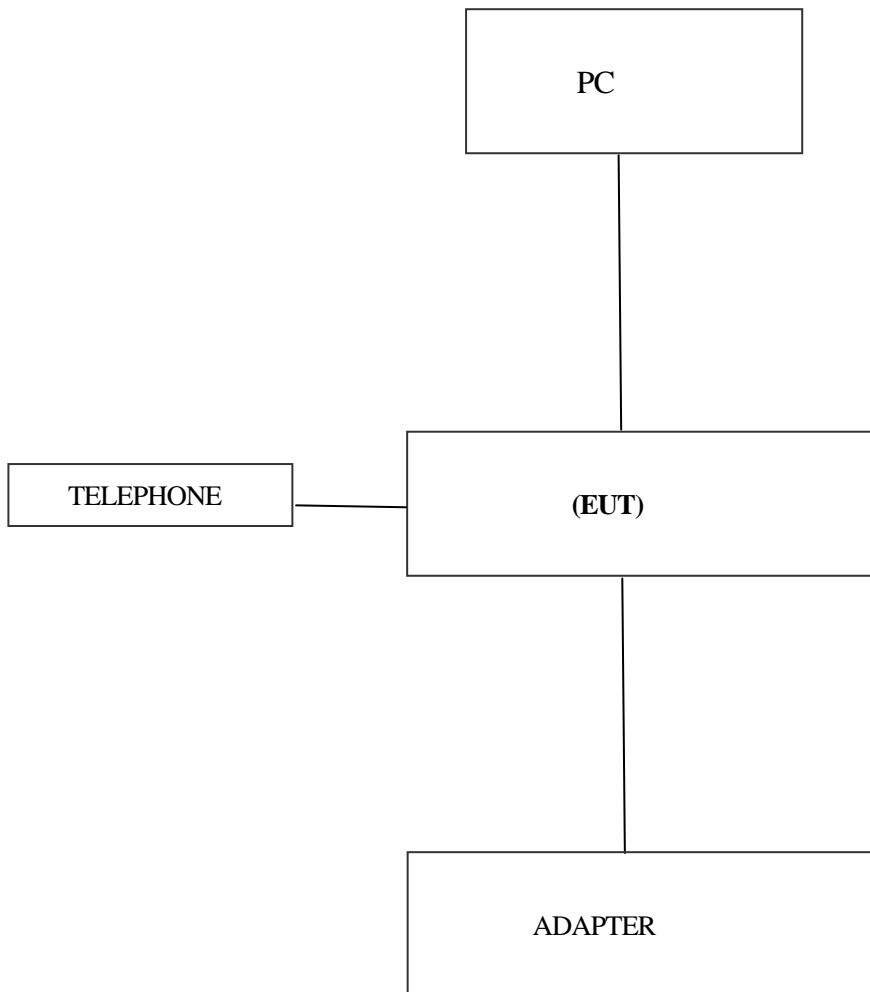

SUMMARY DATA

Conducted Emission Measurement

File :PZD Data :#513 Date: 2016/06/20 Time: 16:37:41

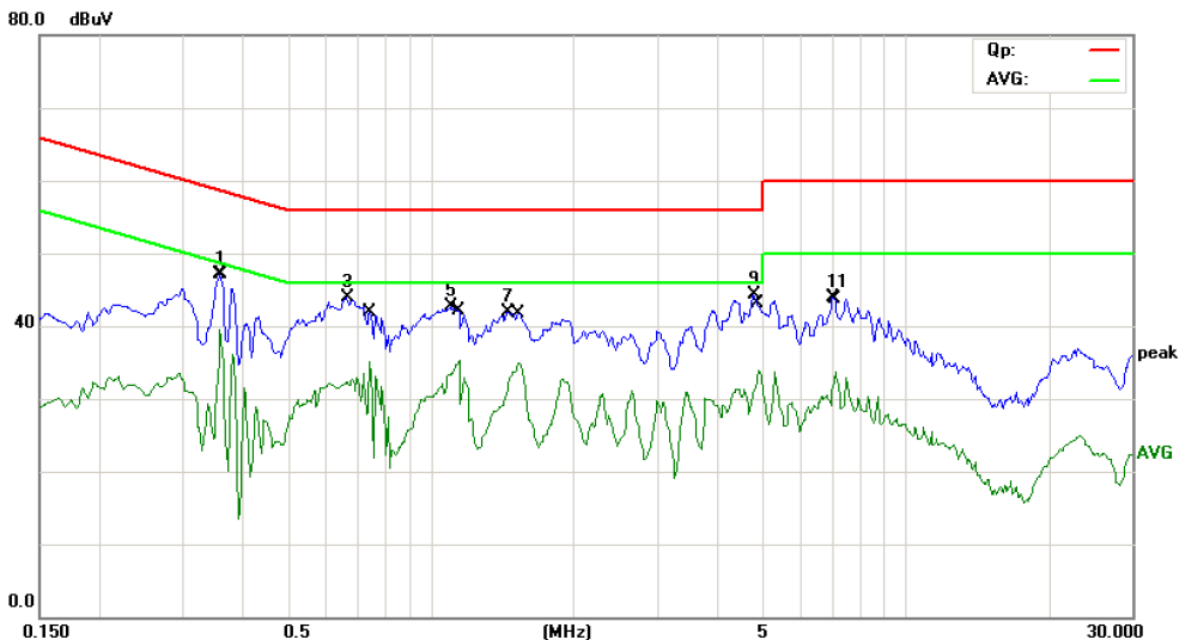

Site site #1 Phase: **L1** Temperature: 25
 Limit: (CE)EN55022 class B_QP Power: AC 230V/50Hz Humidity: 50 %
 EUT: GATEWAY
 M/N: G100S
 Mode: NORMAL
 Note:

No.	Mk.	Freq.	Reading Level	Correct Factor	Measurement	Limit	Over	Detector	Comment
		MHz	dBuV	dB	dBuV	dBuV	dB		
1		0.3600	47.10	0.00	47.10	58.73	-11.63	peak	
2	*	0.3600	39.46	0.00	39.46	48.73	-9.27	AVG	
3		0.6650	43.81	0.00	43.81	56.00	-12.19	peak	
4		0.7450	35.15	0.00	35.15	46.00	-10.85	AVG	
5		1.1000	42.73	0.00	42.73	56.00	-13.27	peak	
6		1.1500	35.24	0.00	35.24	46.00	-10.76	AVG	
7		1.4450	41.89	0.00	41.89	56.00	-14.11	peak	
8		1.5350	34.94	0.00	34.94	46.00	-11.06	AVG	
9		4.7800	44.30	0.00	44.30	56.00	-11.70	peak	
10		4.9100	33.87	0.00	33.87	46.00	-12.13	AVG	
11		7.0100	43.90	0.00	43.90	60.00	-16.10	peak	
12		7.1000	33.63	0.00	33.63	50.00	-16.37	AVG	

SUMMARY DATA

Conducted Emission Measurement

File :PZD Data :#514 Date: 2016/06/20 Time: 16:38:18

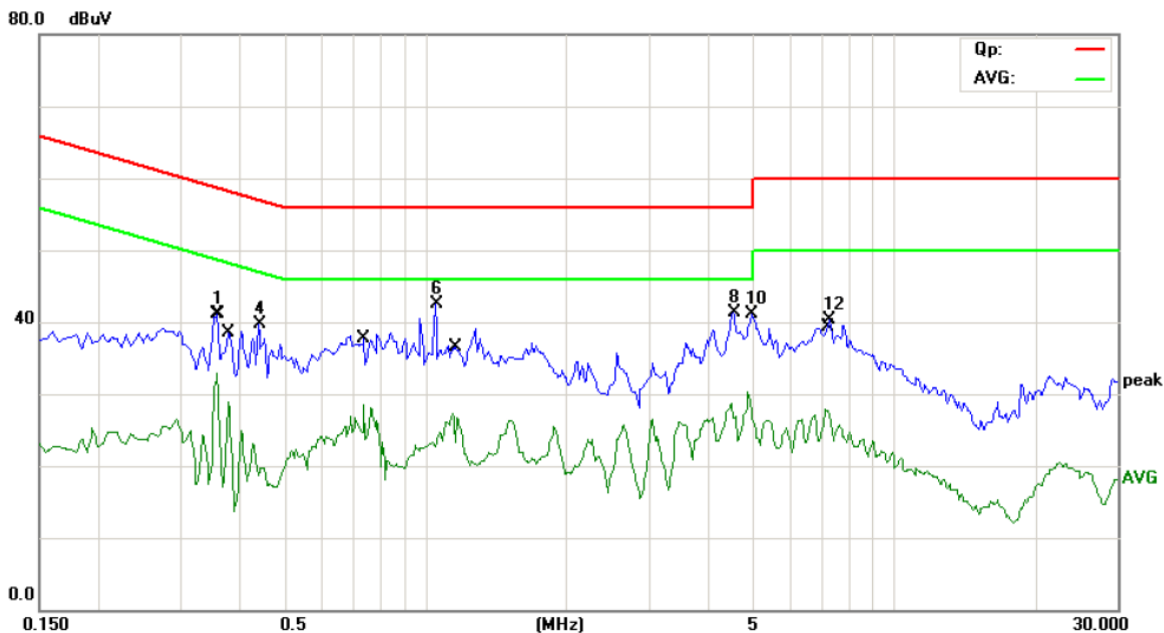

Site site #1 Phase: **N** Temperature: 25
 Limit: (CE)EN55022 class B_QP Power: AC 230V/50Hz Humidity: 50 %
 EUT: GATEWAY
 M/N: G100S
 Mode: NORMAL
 Note:

No. Mk.	Freq. MHz	Reading Level dBuV	Correct Factor dB	Measure- ment dBuV	Limit dBuV	Over dB	Detector	Comment
1	0.3600	41.03	0.00	41.03	58.73	-17.70	peak	
2	0.3600	33.00	0.00	33.00	48.73	-15.73	AVG	
3	0.3800	28.91	0.00	28.91	48.28	-19.37	AVG	
4	0.4400	39.64	0.00	39.64	57.06	-17.42	peak	
5	0.7400	28.59	0.00	28.59	46.00	-17.41	AVG	
6 *	1.0500	42.46	0.00	42.46	56.00	-13.54	peak	
7	1.1450	27.29	0.00	27.29	46.00	-18.71	AVG	
8	4.5400	41.31	0.00	41.31	56.00	-14.69	peak	
9	4.8900	30.30	0.00	30.30	46.00	-15.70	AVG	
10	4.9600	41.01	0.00	41.01	56.00	-14.99	peak	
11	7.1300	27.93	0.00	27.93	50.00	-22.07	AVG	
12	7.2900	40.36	0.00	40.36	60.00	-19.64	peak	

SUMMARY DATA

Radiated Emission Measurement

File :PZD

Data :#060

Date: 2016-6-20

Time: 08:39:35

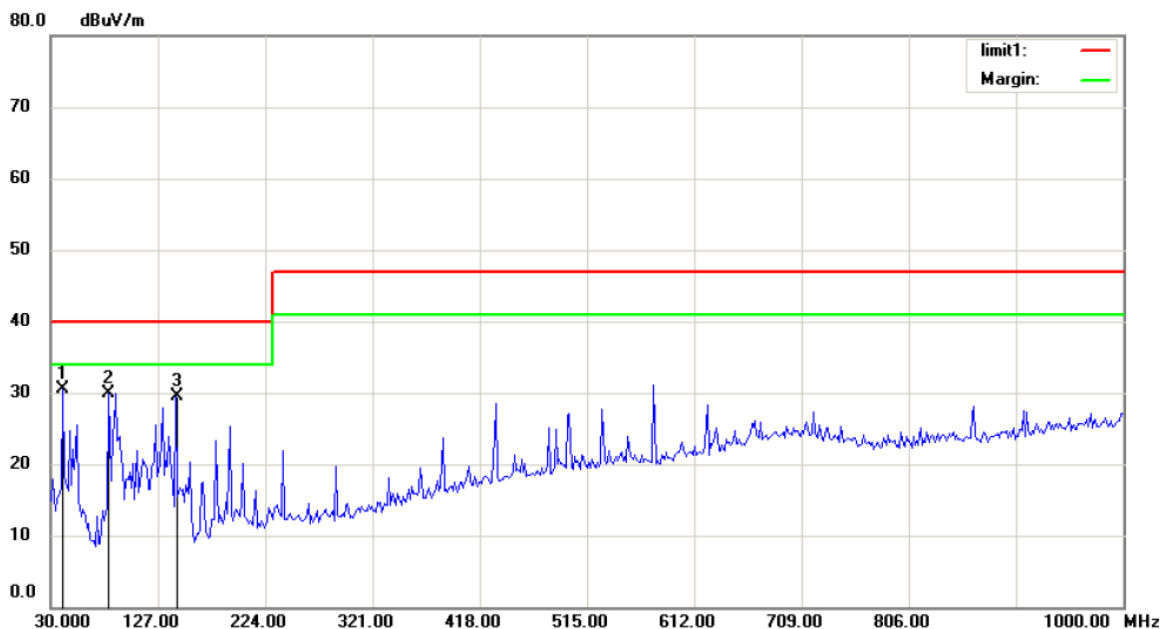

Site site #1 Polarization: **Vertical** Temperature: 26
 Limit: (RE)EN55022 class B Power:AC230V/50Hz Humidity: 50 %
 EUT: GATEWAY
 M/N: G100S
 Mode:NORMAL
 Note:

No.	Mk.	Freq. MHz	Reading Level dBuV	Correct Factor dB	Measure- ment dBuV/m	Limit dBuV/m	Over dB	Detector	Antenna Height cm	Table Degree	Comment
1	*	40.8814	16.31	14.12	30.43	40.00	-9.57	peak			
2		82.8525	19.86	10.09	29.95	40.00	-10.05	peak			
3		143.4776	20.57	8.90	29.47	40.00	-10.53	peak			

SUMMARY DATA

Radiated Emission Measurement

File :PZD

Data :#061

Date: 2016-6-20

Time: 09:40:58

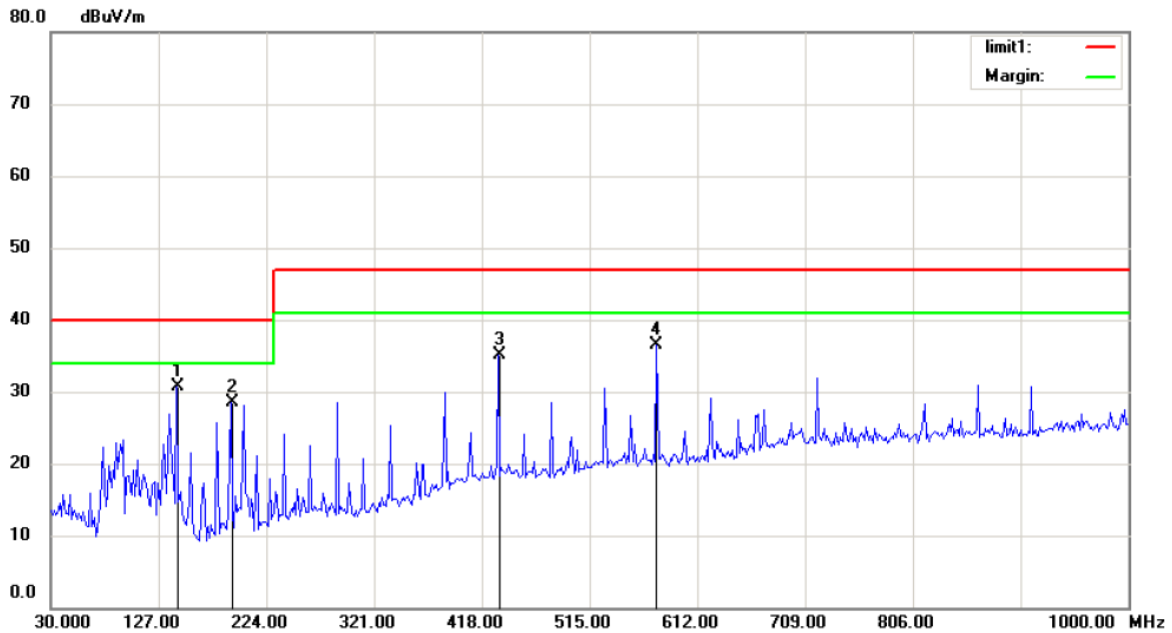

Site site #1

Polarization: **Horizontal**

Temperature: 26

Limit: (RE)EN55022 class B

Power:AC250V/50Hz

Humidity: 50 %

EUT: GATEWAY

M/N: G100S

Mode:NORMAL

Note:

No.	Mk.	Freq.	Reading Level	Correct Factor	Measurement	Limit	Over	Antenna Height	Table Degree	
		MHz	dBuV	dB	dBuV/m	dBuV/m	dB	cm	degree	Comment
1	*	143.4776	21.75	8.89	30.64	40.00	-9.36			peak
2		191.6667	17.47	10.98	28.45	40.00	-11.55			peak
3		432.6122	16.44	18.57	35.01	47.00	-11.99			peak
4		575.6250	16.58	19.83	36.41	47.00	-10.59			peak

SECTION 2 EN 61000-3-2 & EN 61000-3-3 (POWER HARMONICS & VOLTAGE FLUCTUATION / FLICKER)

POWER HARMONICS MEASUREMENT

Port : AC mains

Basic Standard : EN 61000-3-2

Limits : CLASS A; CLASS D

Temperature : 25°C

Humidity : 50%

VOLTAGE FLUCTUATION/FLICKER MEASUREMENT

Port : AC mains

Basic Standard : EN 61000-3-3

Limits : § 5 of EN 61000-3-3

Temperature : 25°C

Humidity : 50%

Block Diagram of Test Setup:

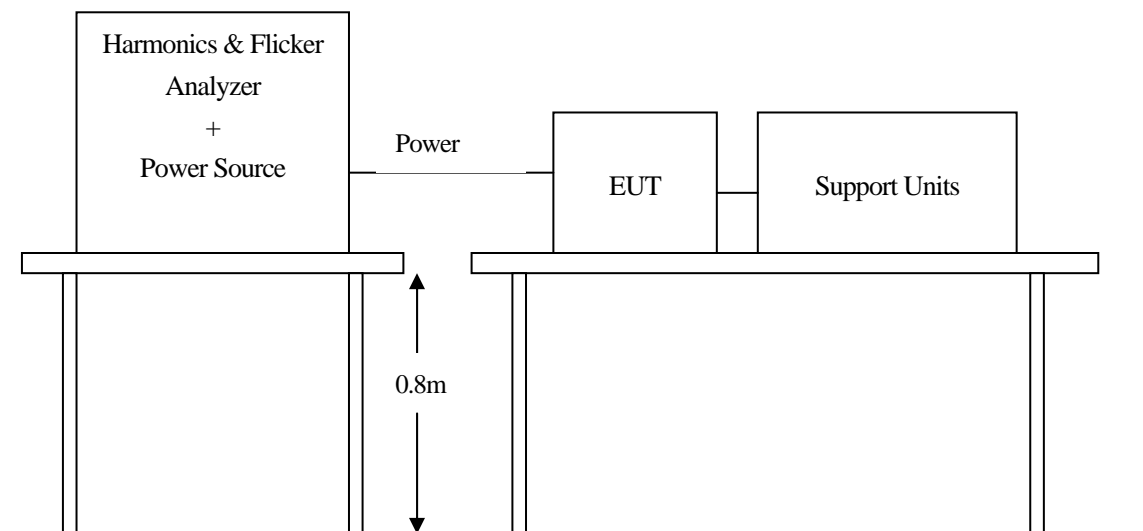

Result:

Please see the attached test data. According to the standard ,EN61000-3-2 need not to be carried out.

Flicker Test Summary per EN/IEC61000-3-3 (Run time)

EUT: GATEWAY (G100S) Tested by: XU
 Test category: All parameters (European limits) Test Margin: 100
 Test date: 2016-06-20 Start time: 09:10:16 End time: 09:21:21
 Test duration (min): 10 Data file name: F-000939.cts_data
 Comment: ON
 Customer: PZD

Test Result: Pass

Status: Test Completed

Pst_i and limit line

European Limits

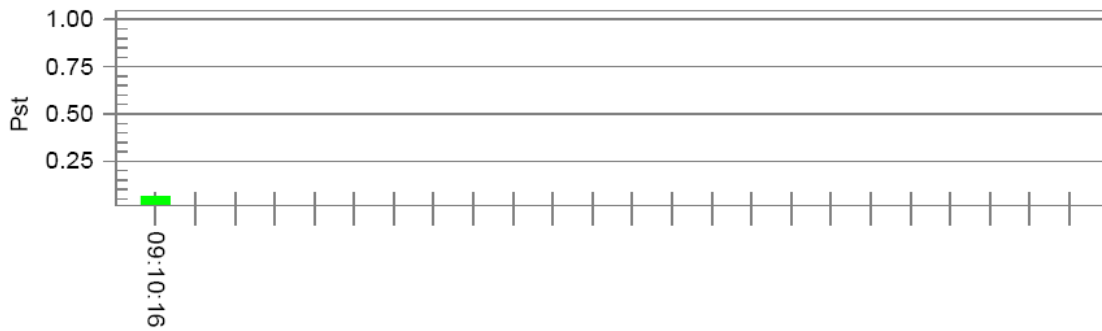

Plt and limit line

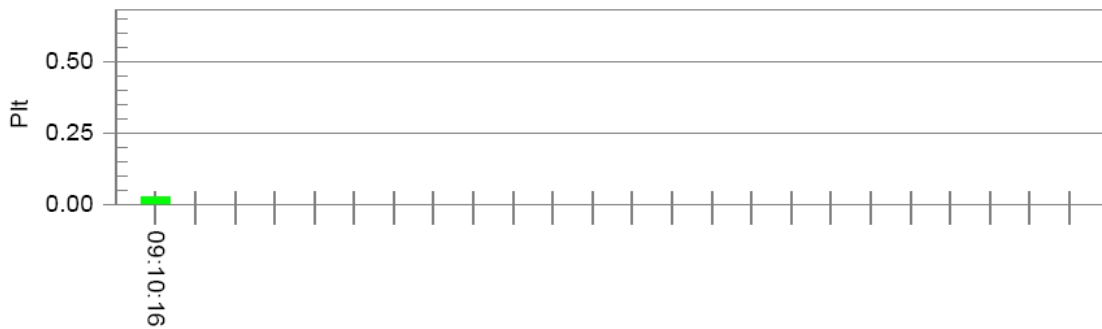

Parameter values recorded during the test:

Vrms at the end of test (Volt):	229.88		
Highest dt (%):	0.00	Test limit (%):	3.30 Pass
Time(mS) > dt:	0.0	Test limit (mS):	500.0 Pass
Highest dc (%):	0.00	Test limit (%):	3.30 Pass
Highest dmax (%):	0.00	Test limit (%):	4.00 Pass
Highest Pst (10 min. period):	0.061	Test limit:	1.000 Pass
Highest Plt (2 hr. period):	0.028	Test limit:	0.650 Pass

SECTION 3 EN 61000-4-2 (ELECTROSTATIC DISCHARGE)

ELECTROSTATIC DISCHARGE (ESD) IMMUNITY TEST

Port	:	Enclosure
Basic Standard	:	EN 61000-4-2
Test Level	:	± 8 kV (Air Discharge) ± 4 kV (Contact Discharge)
Performance Criteria	:	B (Standard require)
Temperature	:	25°C
Humidity	:	50%

Block Diagram of Test Setup:

(The 470 k ohm resistors are installed per standard requirement)

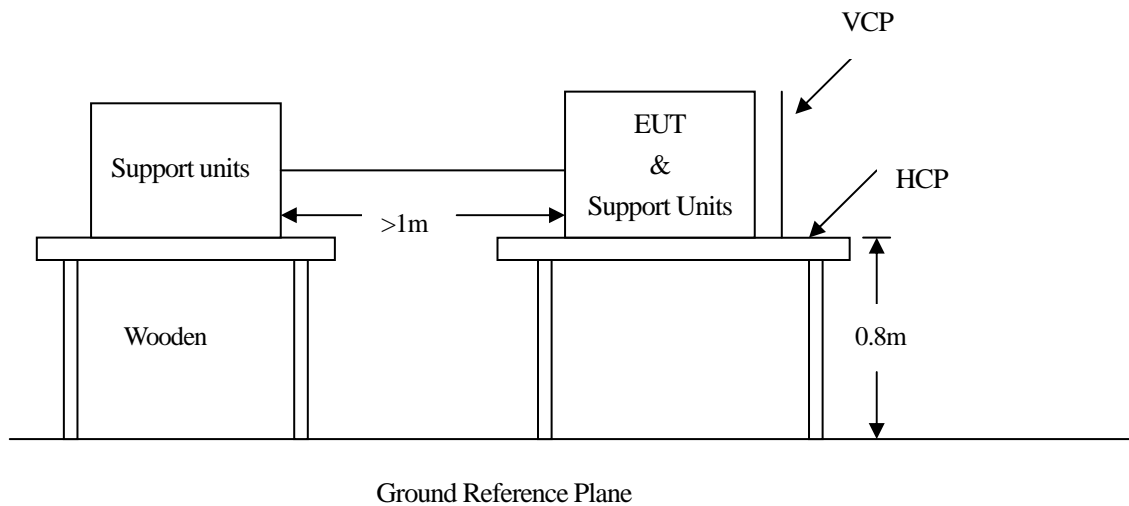

Test Procedure:

1. The EUT was located 0.1 m minimum from all side of the HCP.
2. The support units were located 1 m minimum away from the EUT.
3. Set up EUT and relative support equipments. Then ping the IP from PC to EUT.Keep the program running throughout the test.
4. Active the communication function if the EUT with such port(s).
5. As per the requirement of EN 55024; applying direct contact discharge at the sides other than front of EUT at minimum 50 discharges (25 positive and 25 negative) if applicable, can't be applied direct contact discharge side of EUT then the indirect discharge shall be applied. One of the test points shall be subjected to at least 50 indirect discharge (contact) to the front edge of horizontal coupling plane.
6. Other parts of EUT where it is not possible to perform contact discharge then selecting appropriate points of EUT for air discharge, a minimum of 10 single air discharges shall be applied.
7. The application of ESD to the contact of open connectors is not required.
8. Putting a mark on EUT to show tested points. The following test condition was followed during the tests.

Note: As per the A2 to EN 61000-4-2, a bleed resistor cable is connected between the EUT and HCP during the test.

The electrostatic discharges were applied as follows:

Amount of Discharges	Voltage	Coupling	Result (Pass/Fail)
Mini 25 /Point	$\pm 2\text{kV}; \pm 4\text{kV}; \pm 8\text{kV}$	Contact Discharge	Pass
Mini 25 /Point	$\pm 2\text{kV}; \pm 4\text{kV}; \pm 8\text{kV}$	Indirect Discharge HCP (Front)	Pass
Mini 25 /Point	$\pm 2\text{kV}; \pm 4\text{kV}; \pm 8\text{kV}$	Indirect Discharge VCP (Left)	Pass
Mini 25 /Point	$\pm 2\text{kV}; \pm 4\text{kV}; \pm 8\text{kV}$	Indirect Discharge VCP (Back)	Pass
Mini 25 /Point	$\pm 2\text{kV}; \pm 4\text{kV}; \pm 8\text{kV}$	Indirect Discharge VCP (Right)	Pass
Mini 10 /Point	$\pm 2\text{kV}; \pm 4\text{kV}; \pm 8\text{kV}$	Air Discharge	Pass

Performance & Result:

- Criteria A:** The apparatus continues to operate as intended. No degradation of performance or loss of function is allowed below a performance level specified by the manufacturer, when the apparatus is used as intended. In some cases the performance level may be replaced by a permissible loss of performance.
- Criteria B:** The apparatus continues to operate as intended after the test. No degradation of performance or loss of function is allowed below a performance level specified by the manufacturer, when the apparatus is used as intended. In some cases the performance level may be replaced by a permissible loss of performance. During the test, degradation of performance is however allowed.
- Criteria C:** Temporary loss of function is allowed, provided the functions self recoverable or can be restored by the operation of controls.

SECTION 4 EN 61000-4-3 (RADIATED ELECTROMAGNETIC FIELD)

RADIATED ELECTROMAGNETIC FIELD IMMUNITY TEST

Port	:	Enclosure
Basic Standard	:	EN 61000-4-3:
Requirements	:	3 V/m with 80% AM. 1kHz Modulation.
Performance Criteria	:	A (Standard require)
Temperature	:	25°C
Humidity	:	50%

Block Diagram of Test Setup:

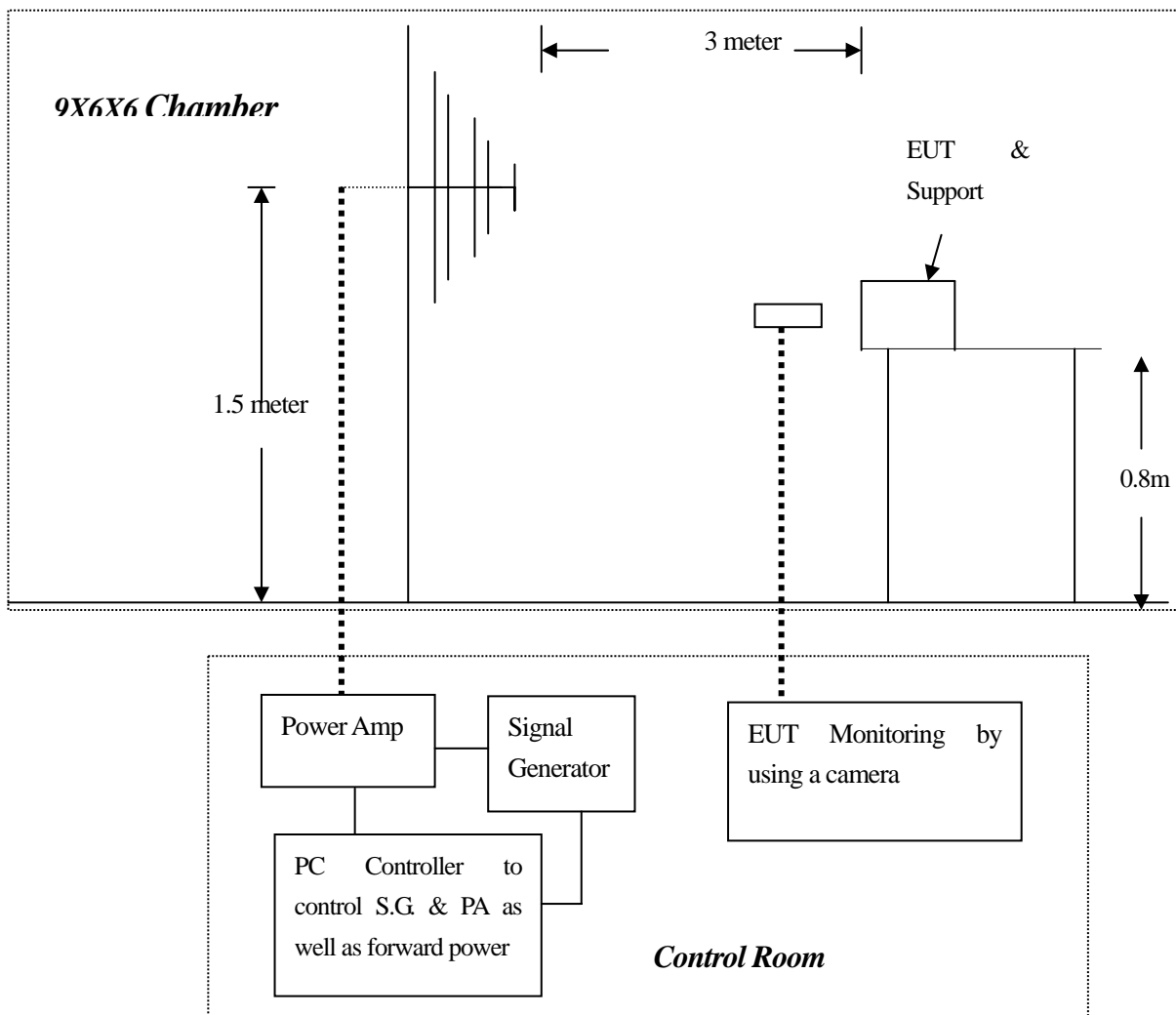

Test Procedure:

1. The EUT was located at the edge of supporting table keep 3 meter away from transmitting antenna, it just the calibrated square area of field uniformity. The support units were located outside of the uniformity area, but the cable(s) connected with EUT were exposed to the calibrated field as per EN 61000-4-3.
2. EUT was loaded and executed normally.
3. Setting the testing parameters of RS test software per EN 61000-4-3.
4. Performing the pre-test at each side of with double specified level (6V/m) at 4% steps.
5. From the result of pre-test in step 4, choose the worst side of EUT for final test from 80 MHz to 1000 MHz at 1% steps.
6. Recording the test result in following table.
7. It is not necessary to perform test as per annex A of EN 55024 if the EUT doesn't belong to TTE product.

EN 61000-4-3 test conditions:

Test level : 6V/m
 Steps 1 % of fundamental
 Dwell Time : 1 sec

Range (MHz)	Field	Modulation	Polarity	Position (°)	Result (Pass/Fail)
80-1000	3V/m	Yes	H	Front	Pass
80-1000	3V/m	Yes	V	Front	Pass
80-1000	3V/m	Yes	H	Right	Pass
80-1000	3V/m	Yes	V	Right	Pass
80-1000	3V/m	Yes	H	Back	Pass
80-1000	3V/m	Yes	V	Back	Pass
80-1000	3V/m	Yes	H	Left	Pass
80-1000	3V/m	Yes	V	Left	Pass

Performance & Result:

- Criteria A:** The apparatus continues to operate as intended. No degradation of performance or loss of function is allowed below a performance level specified by the manufacturer, when the apparatus is used as intended. In some cases the performance level may be replaced by a permissible loss of performance.
- Criteria B:** The apparatus continues to operate as intended after the test. No degradation of performance or loss of function is allowed below a performance level specified by the manufacturer, when the apparatus is used as intended. In some cases the performance level may be replaced by a permissible loss of performance. During the test, degradation of performance is however allowed.
- Criteria C:** Temporary loss of function is allowed, provided the functions self-recoverable or can be restored by the operation of controls.

<input checked="" type="checkbox"/> PASS	<input type="checkbox"/> FAILED
---	--

SECTION 5 EN 61000-4-4 (FAST TRANSIENTS/BURST)

FAST TRANSIENTS/BURST IMMUNITY TEST

Port	: On Power Supply Lines
Basic Standard	: EN 61000-4-4:
Requirements	: +/- 1kV for Power Supply Lines
Performance Criteria	: B (Standard require)
Temperature	: 25°C
Humidity	: 50%

Block Diagram of Test Setup:

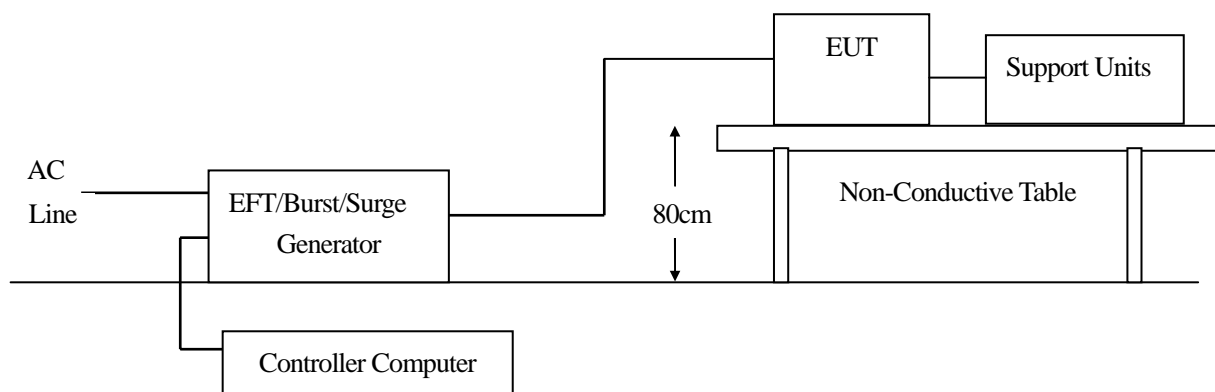

Test Procedure:

1. The EUT and support units were located on a wooden table 0.8 m away from ground reference plane.
2. A 1.0 meter long power cord was attached to EUT during the test.
3. The length of communication cable between communication port and clamp was keeping within 1 meter.
4. Set up all the devices regularly according to the standard.
5. Set up EUT and relative support equipments. Then ping the IP from PC to EUT .Keep the program running throughout the test.
6. Related peripherals work during the test.
7. Recording the test result as shown in following table.

Test conditions:

Impulse Frequency: 5kHz

Tr/Th: 5/50ns

Burst Duration: 15ms

Burst Period: 300ms

Inject Line	Voltage kV	Inject Method	Result (Pass/Fail)
L	+/- 1	Direct	Pass
N	+/- 1	Direct	Pass
PE	+/- 1	Direct	Pass
L+N	+/- 1	Direct	Pass
L+PE	+/- 1	Direct	Pass
N+PE	+/- 1	Direct	Pass
L+N+PE	+/- 1	Direct	Pass

Performance & Result:

- Criteria A:** The apparatus continues to operate as intended. No degradation of performance or loss of function is allowed below a performance level specified by the manufacturer, when the apparatus is used as intended. In some cases the performance level may be replaced by a permissible loss of performance.
- Criteria B:** The apparatus continues to operate as intended after the test. No degradation of performance or loss of function is allowed below a performance level specified by the manufacturer, when the apparatus is used as intended. In some cases the performance level may be replaced by a permissible loss of performance. During the test, degradation of performance is however allowed.
- Criteria C:** Temporary loss of function is allowed, provided the functions self recoverable or can be restored by the operation of controls.

<input checked="" type="checkbox"/> PASS <input type="checkbox"/> FAILED
--

SECTION 6 EN 61000-4-5 (SURGE IMMUNITY)

SURGE IMMUNITY TEST

Port : On Power Supply Lines
Basic Standard : EN 61000-4-5

Requirements : +/- 1kV (Line to Line)
: +/- 2kV (Line to Ground)

Performance Criteria : B (Standard require)

Temperature : 25°C

Humidity : 50%

Block Diagram of Test Setup:

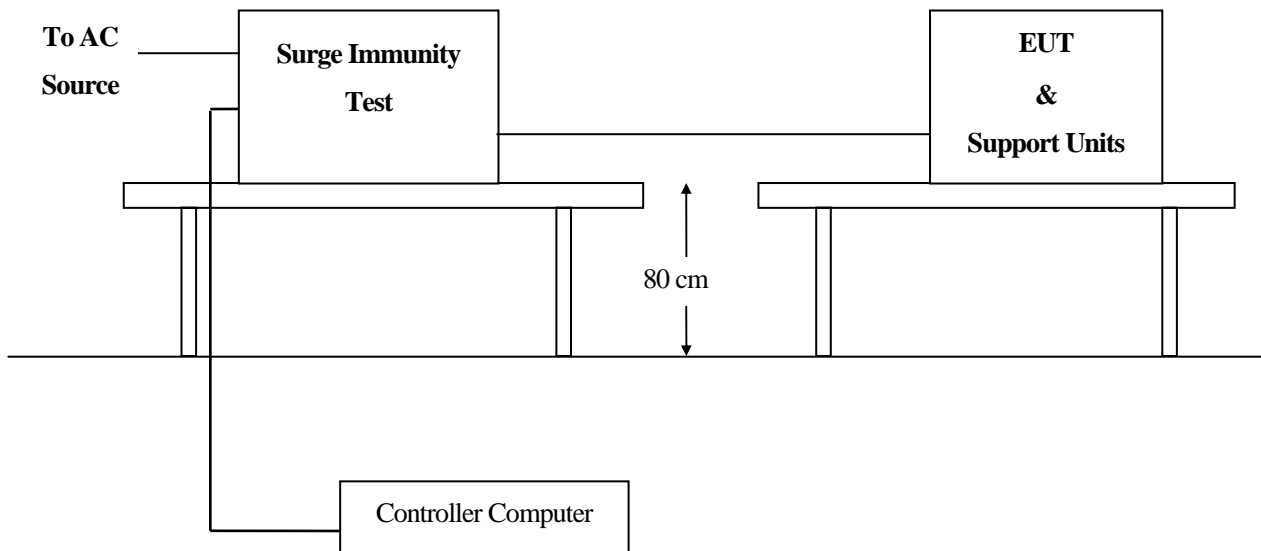

Test Procedure:

1. The EUT and support units were located on a wooden table 0.8 m away from ground floor.
2. Set up all the devices regularly according to the standard.
3. Set up EUT and relative support equipments. Then ping the IP from PC to EUT .Keep the program running throughout the test
4. Related peripherals work during the test.
5. Recording the test result as shown in following table.

Test conditions:

Voltage Waveform : 1.2/50 us
 Current Waveform : 8/20 us
 Polarity : Positive/Negative
 Phase angle : 0°, 90°, 270°
 Number of Test : 5

Coupling Line	Voltage (kV)	Polarity	Coupling Method	Result (Pass/Fail)
L1-L2	1	Positive	Capacitive	Pass
L1-PE	2	Positive	Capacitive	Pass
L2-PE	2	Positive	Capacitive	Pass
L1-L2	1	Negative	Capacitive	Pass
L1-PE	2	Negative	Capacitive	Pass
L2-PE	2	Negative	Capacitive	Pass

Performance & Result:

- Criteria A:** The apparatus continues to operate as intended. No degradation of performance or loss of function is allowed below a performance level specified by the manufacturer, when the apparatus is used as intended. In some cases the performance level may be replaced by a permissible loss of performance.
- Criteria B:** The apparatus continues to operate as intended after the test. No degradation of performance or loss of function is allowed below a performance level specified by the manufacturer, when the apparatus is used as intended. In some cases the performance level may be replaced by a permissible loss of performance. During the test, degradation of performance is however allowed.
- Criteria C:** Temporary loss of function is allowed, provided the functions self recoverable or can be restored by the operation of controls.

<input checked="" type="checkbox"/> PASS	<input type="checkbox"/> FAILED
---	--

SECTION 7 EN 61000-4-6(CONDUCTED DISTRBANCE/INDUCED BY RADIO-FREQUENCY FIELD)

Port	: On Power Supply Lines
Basic Standard	: EN 61000-4-6
Requirements	: 3V with 80% AM. 1kHz Modulation
Injection Method	: CDN
Performance Criteria	: A (Standard require)
Temperature	: 25°C
Humidity	: 50%

Block Diagram of Test Setup:

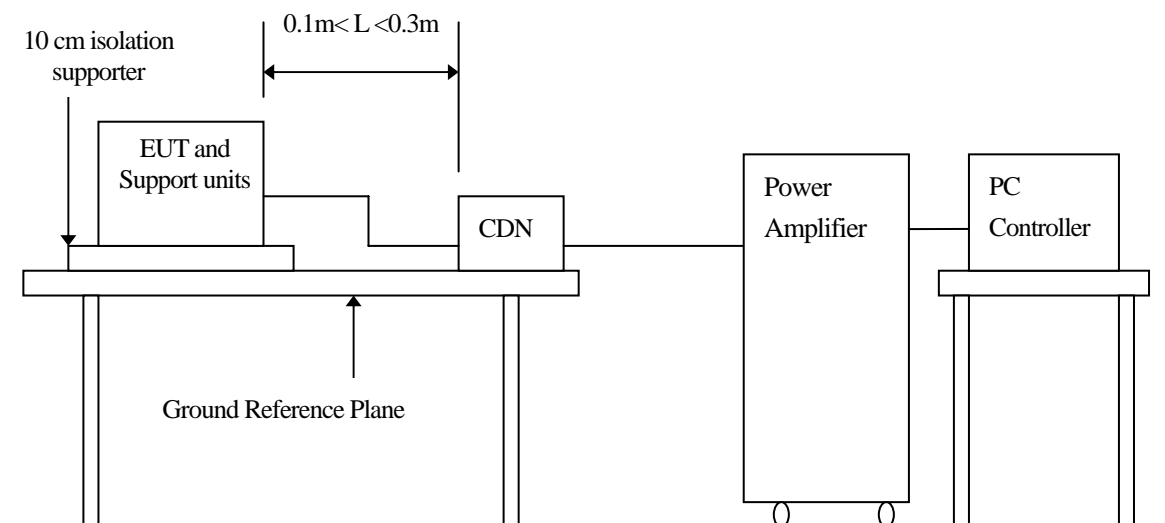

Test Procedure:

1. The EUT and support units were located at a ground reference plane with the interposition of a 0.1 m thickness insulating support and the CDN was located on GRP directly.
2. Set up all the devices regularly according to the standard.
3. Set up EUT and relative support equipments. Then ping the IP from PC to EUT.Keep the program running throughout the test
4. Related peripherals work during the test.
5. Setting the testing parameters of CS test software per EN 61000-4-6.
6. Recording the test result in following table.

Test conditions:

Frequency Range : 0.15MHz-80MHz

Frequency Step : 1% of fundamental

Dwell Time : 1 sec

Range (MHz)	Field	Modulation	Result (Pass/Fail)
0.15-80	3V	Yes	Pass

Performance & Result:

Criteria A: The apparatus continues to operate as intended. No degradation of performance or loss of function is allowed below a performance level specified by the manufacturer, when the apparatus is used as intended. In some cases the performance level may be replaced by a permissible loss of performance.

Criteria B: The apparatus continues to operate as intended after the test. No degradation of performance or loss of function is allowed below a performance level specified by the manufacturer, when the apparatus is used as intended. In some cases the performance level may be replaced by a permissible loss of performance. During the test, degradation of performance is however allowed.

Criteria C: Temporary loss of function is allowed, provided the functions self-recoverable or can be restored by the operation of controls.

PASS **FAILED**

SECTION 8 EN 61000-4-11 (VOLTAGE DIPS, SHORT INTERRUPTIONS AND VOLTAGE VARIATIONS)

VOLTAGE DIPS / SHORT INTERRUPTIONS

Port : On Power Supply Lines
Basic Standard : EN 61000-4-11

Requirement : PHASE ANGLE 0, 45, 90, 135, 180, 225, 270, 315 degrees

Voltage Dips	Test Level	Reduction	Duration	Performance
	% U _T	(%)	(periods)	Criteria
	<5	>95	0.5	B
70	30	25	C	

Voltage Interruptions	Test Level	Reduction	Duration	Performance
	% U _T	(%)	(periods)	Criteria
<5	>95	250	C	

Test Interval : Min. 10 sec.
Temperature : 25°C
Humidity : 50%

Block Diagram of Test Setup:

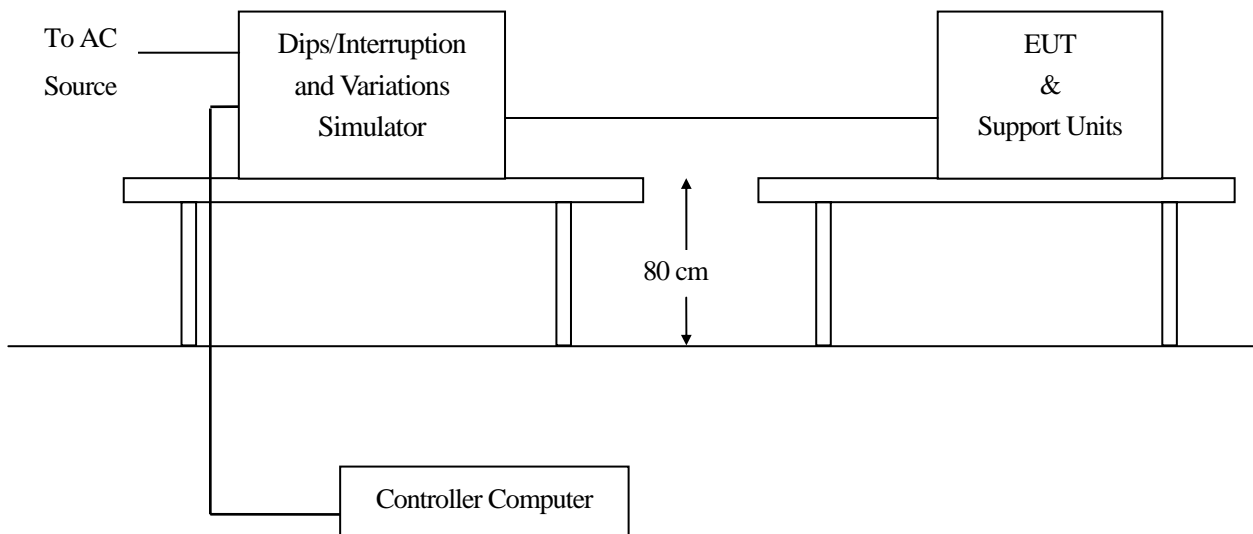

Test Procedure:

1. The EUT and support units were located on a wooden table, 0.8 m away from ground floor.
2. Set up all the devices regularly according to the standard.
3. Set up EUT and relative support equipments. Then ping the IP from PC to EUT .Keep the program running throughout the test
4. Setting the parameter of tests and then Perform the test software of test simulator.
5. Conditions changes to occur at 0 degree crossover point of the voltage waveform.
6. Recording the test result in test record form.

Test conditions:

The duration with a sequence of three dips/interruptions with interval of 10 s minimum
 (Between each test event)

Voltage Dips:

Test Level % U _T	Reduction (%)	Duration (periods)	Observation	Meet Performance Criteria
0	100	0.5	Normal	A
70	30	25	Normal	A

Voltage Interruptions:

Test Level % U _T	Reduction (%)	Duration (periods)	Observation	Meet Performance Criteria
0	100	250	EUT shut down, but can recover by operator.	C

Performance & Result:

Criteria A: The apparatus continues to operate as intended. No degradation of performance or loss of function is allowed below a performance level specified by the manufacturer, when the apparatus is used as intended. In some cases the performance level may be replaced by a permissible loss of performance.

Criteria B: The apparatus continues to operate as intended after the test. No degradation of performance or loss of function is allowed below a performance level specified by the manufacturer, when the apparatus is used as intended. In some cases the performance level may be replaced by a permissible loss of performance. During the test, degradation of performance is however allowed.

Criteria C: Temporary loss of function is allowed, provided the functions self recoverable or can be restored by the operation of controls.

<input checked="" type="checkbox"/> PASS <input type="checkbox"/> FAILED
--

APPENDIX 1

PHOTOGRAPHS OF TEST SETUP

CONDUCTED EMISSION TEST



RADIATED EMISSION TEST (EN 55022)

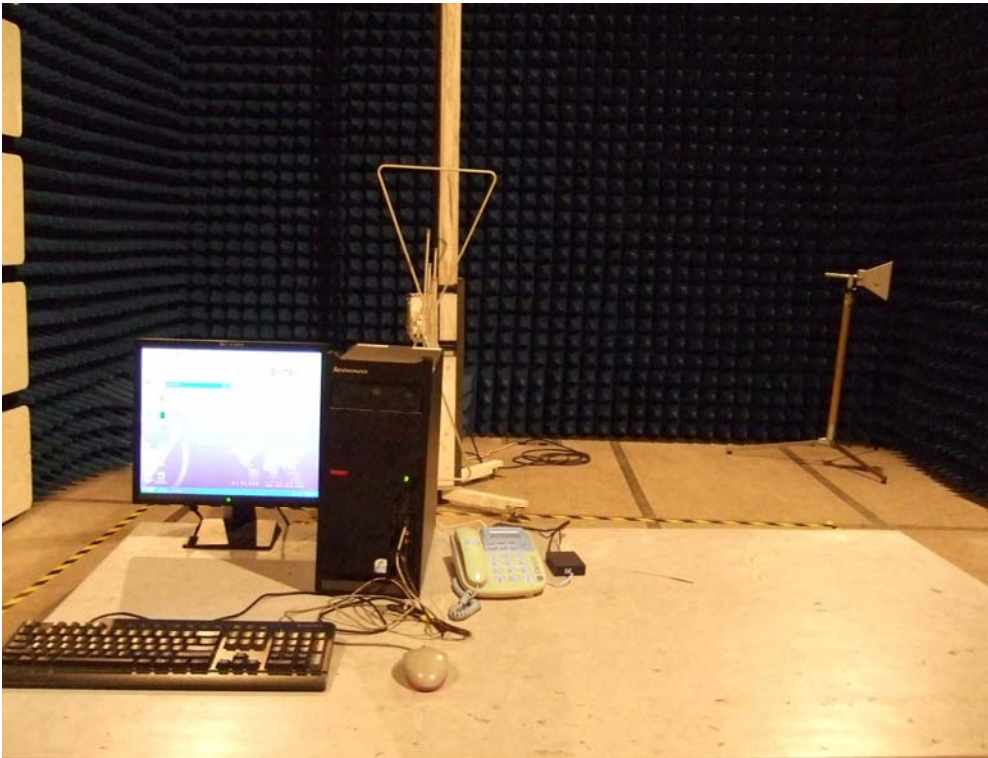

POWER HARMONIC & VOLTAGE FLUCTUATION / FLICKER TEST (EN 61000-3-2, EN 61000-3-3)



ELECTROSTATIC DISCHARGE TEST (EN 61000-4-2)



FAST TRANSIENTS/BURST TEST (EN 61000-4-4)

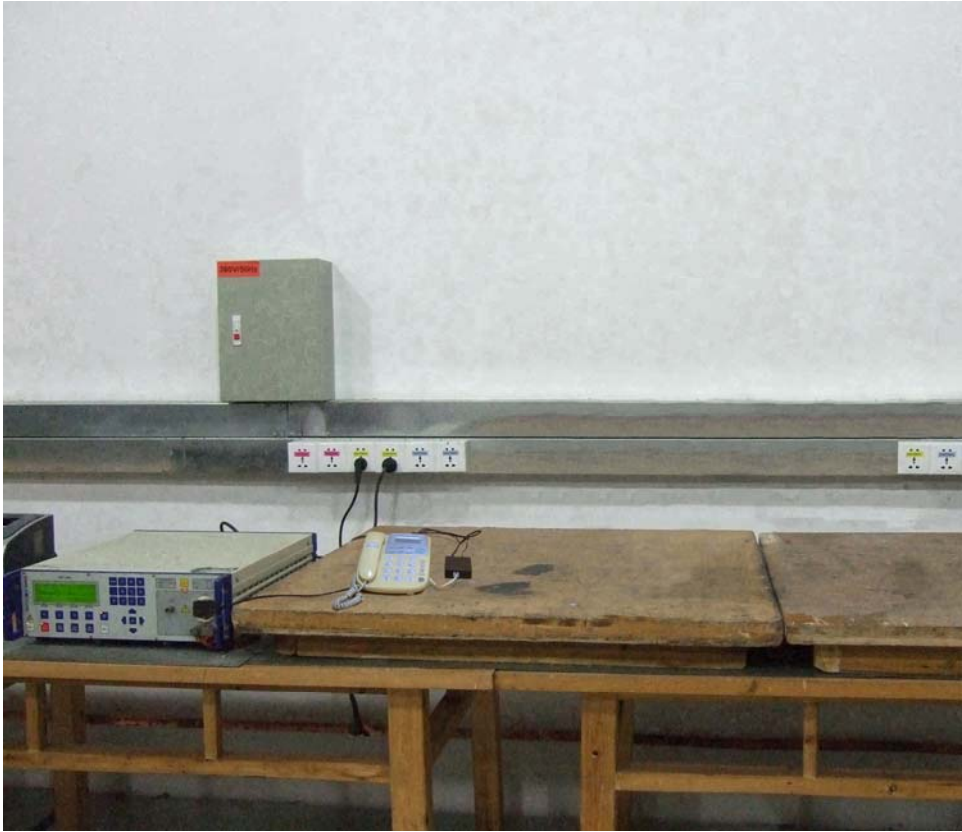

SURGE IMMUNITY TEST (EN 61000-4-5)



CS (EN 61000-4-6)



VOLTAGE DIPS / INTERRUPTION TEST (EN 61000-4-11)



APPENDIX 2

PHOTOGRAPHS OF EUT

TOPVIEW OF EUT



BOTTOMVIEW OF EUT



PORTS OF EUT



PORTS OF EUT



SIDEVIEW OF EUT



PCB1



PCB2

