

FCC CLASS B COMPLIANCE REPORT (DoC)

for

Electromagnetic Emissions
Of

IP PHONE

Trade Name : N/A
Model Number : E52(P)
Serial Number : N/A
Report Number : PZD1306346-F
Date : July 16, 2013
Regulations : FCC PART 15B

Prepared for :

**FANVIL TECHNOLOGY CO., LTD.
LEVEL 3, BLOCK A, GAOXINQI BUILDING,
ANHUA INDUSTRIAL PARK, QIANJIN 1 ROAD, 35TH DISTRICT,
BAO'AN, SHENZHEN, 518101 P.R. CHINA.**

Prepared by :

**SHENZHEN PZD TECHNOLOGY CO.,LTD.
10F,EAST TOWER, XINGHUA BUILDING,NO.2018,SHENNAN ROAD,
FUTIAN DISTRICT,SHENZHEN,GUANGDONG,CHINA
TEL: 86-755-6163-6090
FAX: 86-755-6163-6091**

TABLE OF CONTENTS

FCC CLASS B COMPLIANCE REPORT	1
VERIFICATION OF COMPLIANCE	3
SYSTEM DESCRIPTION	4
PRODUCT INFORMATION	5
SECTION 1 LINE CONDUCTED AND RADIATED EMISSION	7
MEASUREMENT PROCEDURE	7
SUMMARY DATA	14
TEST FACILITY	16
TEST EQUIPMENT LIST	18
BLOCK DIAGRAM OF TEST SETUP	19
APPENDIX 1	20
APPENDIX 2	22

VERIFICATION OF COMPLIANCE

Equipment Under Test: IP PHONE
Trade Name: N/A
Model Number: E52(P)
Serial Number: N/A
EUT Powered during test: DC5V
Applicant: FANVIL TECHNOLOGY CO., LTD.
LEVEL 3, BLOCK A, GAOXINQI BUILDING,
ANHUA INDUSTRIAL PARK, QIANJIN 1 ROAD, 35TH DISTRICT,
BAO'AN, SHENZHEN, 518101 P.R. CHINA.
Manufacturer: FANVIL TECHNOLOGY CO., LTD.
LEVEL 3, BLOCK A, GAOXINQI BUILDING,
ANHUA INDUSTRIAL PARK, QIANJIN 1 ROAD, 35TH DISTRICT,
BAO'AN, SHENZHEN, 518101 P.R. CHINA.
Type of Test: FCC Class B (DoC)
Measurement Procedure: ANSI C63.4: 2009
File Number: PZD1306346-F
Date of test: July 13,2013
Deviation: None
Condition of Test Sample: Normal

The above equipment was tested by Shenzhen PZD Technology Co.,Ltd.. for compliance with the requirements set forth in the FCC Rules and Regulations Part 15, Subpart B and the measurement procedure according to ANSI C63.4. This said equipment in the configuration described in this report shows the maximum emission levels emanating from equipment are within the compliance requirements.

The test results of this report relate only to the tested sample identified in this report.

Approved By:

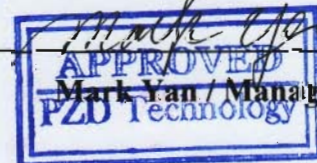

SYSTEM DESCRIPTION

EUT Test Program:

NORMAL MODE

1. Set up EUT and relative support equipments.
2. Connect the net cable to the EUT and /or the PC,working normally
3. Keep the program running throughout the test.

PRODUCT INFORMATION

Housing Type:	Plastic
EUT Power Rating:	DC 5V from adapter
Adapter Manufacturer/Model	Input:100-240VAC 50-60Hz 0.3A Max
DC Output Cable:	Unshielded, 1.5m
Net Cable	Unshielded, 1.5m
OSC Frequency	25MHz

I/O Port of EUT:

E52(P)	I/O Port Type	Q'TY	Tested with
1)	RJ45 port	2	2
2)	DC INLET	1	1
3)	RJ11 HEADSET	1	1

Difference between model numbers as below:

N/A

SUPPORT EQUIPMENT

No.	Equipment	Model #	Serial #	Trade Name	Data Cable	Power Cord
1)	PC	M4600C	NS04619689	LENOVO	N/A	Unshielded 1.8m
2)	Keyboard	SK-8115	CN-0J4635-7161 6-61 F-1U27	LENOVO	Shielded 1.8 m	N/A
3)	Mouse	M-S69	323614-001	LENOVO	Shielded 1.8 m	N/A
4)	Monitor	VP201B	A21050402549	View Sonic	Shielded 1.8 m	Shielded 1.5m

Note: All the above equipment/cables were placed in worse case positions to maximize emission signals during emission test.

Grounding: Grounding was in accordance with the manufacturer's requirements and conditions for the intended use.

SECTION 1 LINE CONDUCTED AND RADIATED EMISSION

MEASUREMENT PROCEDURE

(PRELIMINARY LINE CONDUCTED EMISSION TEST)

- 1) The equipment was set up as per the test configuration to simulate typical actual usage per the user's manual. When the EUT is a tabletop system, a wooden table with a height of 0.8 meters is used and is placed on the ground plane as per ANSI C63.4 (see Test Facility for the dimensions of the ground plane used). When the EUT is a floor-standing equipment, it is placed on the ground plane which has a 3-12 mm non-conductive covering to insulate the EUT from the ground plane.
- 2) Support equipment, if needed, was placed as per ANSI C63.4.
- 3) All I/O cables were positioned to simulate typical actual usage as per ANSI C63.4.
- 4) The EUT received DC power from a adapter received power through a Line Impedance Stabilization Network (LISN) which supplied power source and was grounded to the ground plane.
- 5) All support equipment received power from a second LISN supplying power of 120VAC/60Hz, if any.
- 6) The EUT test program was started. Emissions were measured on each current carrying line of the EUT using a spectrum Analyzer / Receiver connected to the LISN powering the EUT. The LISN has two monitoring points: Line 1 (Hot Side) and Line 2 (Neutral Side). Two scans were taken: one with Line 1 connected to Analyzer / Receiver and Line 2 connected to a 50 ohm load; the second scan had Line 1 connected to a 50 ohm load and Line 2 connected to the Analyzer / Receiver.
- 7) Analyzer / Receiver scanned from 150kHz to 30MHz for emissions in each of the test modes.
- 8) During the above scans, the emissions were maximized by cable manipulation.
- 9) The following test mode(s) were scanned during the preliminary test:

Preliminary Conducted Emission Test			
Frequency Range Investigated		150KHz TO 30 MHz	
Mode of operation	Date	Data Report No.	Worst Mode
Normal	2013-06-13	E52(P)_0(L, N)	<input checked="" type="checkbox"/>

Then, the EUT configuration and cable configuration of the above highest emission level were recorded for reference of final testing.

MEASUREMENT PROCEDURE (FINAL LINE CONDUCTED EMISSION TEST)

- 1) EUT and support equipment was set up on the test bench as per step 9 of the preliminary test.
- 2) A scan was taken on both power lines, Line 1 and Line 2, recording at least the six highest emissions. Emission frequency and amplitude were recorded into a computer in which correction factors were used to calculate the emission level and compare reading to the applicable limit. If EUT emission level was less -2dB to the A.V. limit in Peak mode, then the emission signal was re-checked using an Average detector.
- 3) The test data of the worst case condition(s) was reported on the Summary Data page.

Data Sample:

Freq. MHz	Peak Raw dBuV	Q.P. Raw dBuV	Average Raw dBuV	Q.P. Limit dBuV	Average Limit dBuV	Q.P. Margin dB	Average Margin dB	Note
x.xx	44.0	---	---	56.0	46.0	---	-2.0	L 1

- Freq. = Emission frequency in MHz
- Raw dBuV = Uncorrected Analyzer/Receiver reading
- Limit dBuV = Limit stated in standard
- Margin dB = Reading in reference to limit
- Note = Current carrying line of reading
- “---“ = The emission level complied with the Average limits, with at least 2 dB margin, so no further recheck.

LINE CONDUCTED EMISSION LIMIT

Frequency	Maximum RF Line Voltage	
	Q.P.	AVERAGE
150kHz-500kHz	66-56dBuV	56-46dBuV
500kHz-5MHz	56dBuV	46dBuV
5MHz-30MHz	60dBuV	50dBuV

Note: The lower limit shall apply at the transition frequency.

MEASUREMENT PROCEDURE (PRELIMINARY RADIATED EMISSION TEST)

- 1) The equipment was set up as per the test configuration to simulate typical actual usage per the user's manual. When the EUT is a tabletop system, a wooden turntable with a height of 0.8 meters is used which is placed on the ground plane as per ANSI C63.4(see Test Facility for the dimensions of the ground plane used). When the EUT is a floor-standing equipment, it is placed on the ground plane which has a 3-12 mm non-conductive covering to insulate the EUT from the ground plane.
- 2) Support equipment, if needed, was placed as per ANSI C63.4.
- 3) All I/O cables were positioned to simulate typical actual usage as per ANSI C63.4.
- 4) The EUT received from a adapter received power from battery or PC via USB port. Run cpoytest program. All support equipment received 120VAC/60Hz power from socket under the turntable, if any.
- 5) The antenna was placed at 10 meter away from the EUT as stated in CISPR 22, The antenna connected to the Analyzer via a cable and at times a pre-amplifier would be used.
- 6) The Analyzer / Receiver quickly scanned from 30MHz to 1000MHz. The EUT test program was started. Emissions were scanned and measured rotating the EUT to 360 degrees and positioning the antenna 1 to 4 meters above the ground plane, in both the vertical and the horizontal polarization, to maximize the emission reading level.
- 7) The following test mode(s) were scanned during the preliminary test:

Preliminary Radiated Emission Test			
Frequency Range Investigated		30 MHz TO 1000 MHz	
Mode of operation	Date	Data Report No.	Worst Mode
NORMAL	2013/06/13	E52(P)_002(V,H)	<input checked="" type="checkbox"/>

Then, the EUT and cable configuration, antenna position, polarization and turntable position of the above highest emission level were recorded for final testing.

MEASUREMENT PROCEDURE (FINAL RADIATED EMISSION TEST)

- 1) EUT and support equipment were set up on the turntable as per step 7 of the preliminary test.
- 2) The Analyzer / Receiver scanned from 30MHz to 1000MHz. Emissions were scanned and measured rotating the EUT to 360 degrees, varying cable placement and positioning the antenna 1 to 4 meters above the ground plane, in both the vertical and the horizontal polarization, to maximize the emission reading level.
- 3) Recorded at least the six highest emissions. Emission frequency, amplitude, antenna position, polarization and turntable position were recorded into a computer in which correction factors were used to calculate the emission level and compare reading to the applicable limit and Peak/Q.P. reading is presented.
- 4) The test data of the worst case condition(s) was reported on the Summary Data page.

Data Sample:

Freq. (MHz)	Raw Data (dBuV/m)	Corr. Factor (dB)	Emiss. Level (dBuV/m)	Limits	Margin (dB)	Reading Type (P/Q)
xx.xx	24.00	12.20	36.20	40.00	-3.80	P

- Freq. = Emission frequency in MHz
- Raw Data (dBuV/m) = Uncorrected Analyzer / Receiver reading
- Corr. Factor (dB) = Correction factors of antenna factor and cable loss
- Emiss. Level = Raw reading converted to dBuV/m and CF added
- Limit dBuV/m = Limit stated in standard
- Margin dB = Reading in reference to limit
- P =Peak Reading
- Q =Quasi-peak

RADIATED EMISSION LIMIT

Frequency (MHz)	Distance (m)	Maximum Field Strength Limit (dBuV/m/ Q.P.)
30-88	3	40.0
88-216	3	43.5
216-960	3	46.0
960-	3	54.0

Note: The lower limit shall apply at the transition frequency.

SUMMARY DATA

Conducted Emission Measurement

File :PZD Data :#507 Date: 2013/07/13 Time: 09:25:21

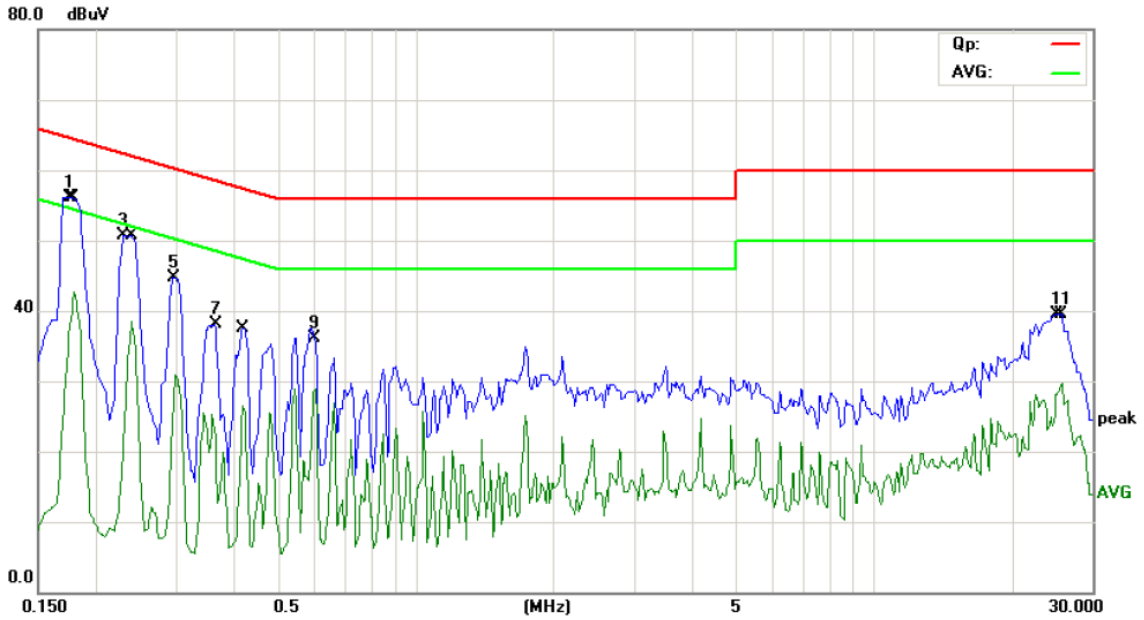

Site: Conduction #1	Phase: N	Temperature: 26
Limit: (CE)FCC PART 15 class B_QP	Power: AC 120V/60Hz	Humidity: 50 %
EUT: IP PHONE		
M/N: E52(P)		
Mode: ON		
Note:		

No.	Mk.	Freq. MHz	Reading Level dBuV	Correct Factor dB	Measure- ment dBuV	Limit dBuV	Over dB	Detector	Comment
1	*	0.1750	56.07	0.00	56.07	64.72	-8.65	peak	
2		0.1800	42.64	0.00	42.64	54.49	-11.85	AVG	
3		0.2300	50.76	0.00	50.76	62.45	-11.69	peak	
4		0.2400	38.47	0.00	38.47	52.10	-13.63	AVG	
5		0.2950	44.65	0.00	44.65	60.38	-15.73	peak	
6		0.3000	30.81	0.00	30.81	50.24	-19.43	AVG	
7		0.3650	38.03	0.00	38.03	58.61	-20.58	peak	
8		0.4200	26.49	0.00	26.49	47.45	-20.96	AVG	
9		0.6010	36.09	0.00	36.09	56.00	-19.91	peak	
10		0.6050	28.94	0.00	28.94	46.00	-17.06	AVG	
11		25.0500	39.59	0.00	39.59	60.00	-20.41	peak	
12		25.7500	29.67	0.00	29.67	50.00	-20.33	AVG	

SUMMARY DATA

Conducted Emission Measurement

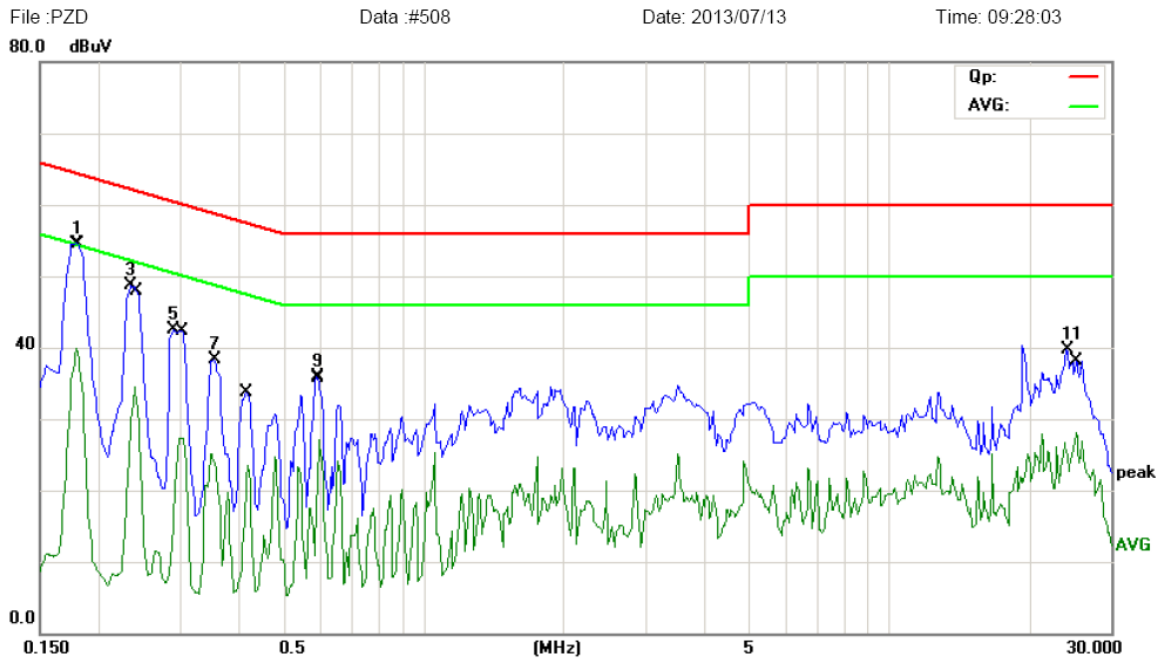

Site Conduction #1	Phase: L1	Temperature: 26
Limit: (CE)FCC PART 15 class B_QP	Power: AC 120V/60Hz	Humidity: 50 %
EUT: IP PHONE		
M/N: E52(P)		
Mode: ON		
Note:		

No.	Mk.	Freq. MHz	Reading Level dBuV	Correct Factor dB	Measure- ment dBuV	Limit dBuV	Over dB	Detector	Comment
1	*	0.1800	54.60	0.00	54.60	64.49	-9.89	peak	
2		0.1800	39.90	0.00	39.90	54.49	-14.59	AVG	
3		0.2350	48.62	0.00	48.62	62.27	-13.65	peak	
4		0.2430	31.33	0.00	31.33	51.99	-20.66	AVG	
5		0.2900	42.44	0.00	42.44	60.52	-18.08	peak	
6		0.3050	27.34	0.00	27.34	50.11	-22.77	AVG	
7		0.3550	38.27	0.00	38.27	58.84	-20.57	peak	
8		0.4200	23.53	0.00	23.53	47.45	-23.92	AVG	
9		0.5900	35.99	0.00	35.99	56.00	-20.01	peak	
10		0.5950	27.20	0.00	27.20	46.00	-18.80	AVG	
11		24.1250	39.67	0.00	39.67	60.00	-20.33	peak	

SUMMARY DATA

Radiated Emission Measurement

File :PZD Data :#865 Date: 2013/07/13 Time: 11:53:19

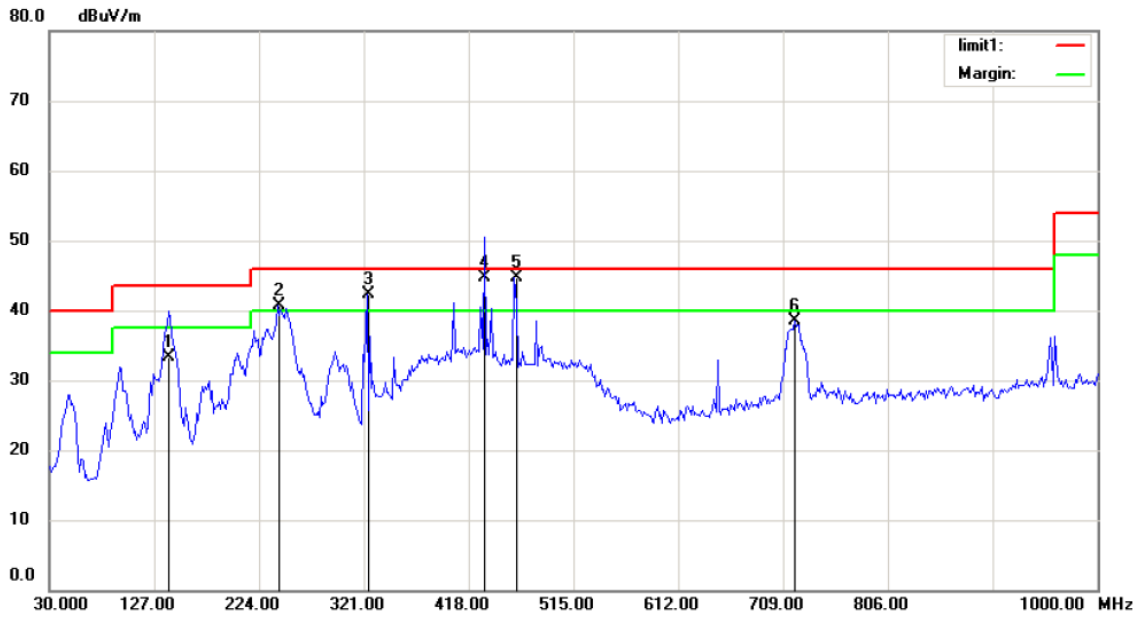

Site site #1 Polarization: **Horizontal** Temperature: 26
 Limit: (RE)FCC PART 15 CLASS B Power: 120V/60Hz Humidity: 50 %
 EUT: IP PHONE
 M/N: E52(P)
 Mode: NORMAL
 Note:

No.	Mk.	Freq. MHz	Reading Level dBuV	Correct Factor dB	Measure- ment dBuV/m	Limit dBuV/m	Over dB	Detector	Antenna Height cm	Table Degree degree	Comment
1		140.1280	24.40	8.82	33.22	43.50	-10.28	QP			
2	!	241.4103	27.41	13.22	40.63	46.00	-5.37	QP			
3	!	323.7981	27.65	14.66	42.31	46.00	-3.69	QP			
4	!	431.9960	26.20	18.53	44.73	46.00	-1.27	QP			
5	*	460.5930	26.04	18.73	44.77	46.00	-1.23	QP			
6		720.1923	15.65	22.88	38.53	46.00	-7.47	QP			

TEST FACILITY

Location: Bldg. 69,Majialong Industrial Zone,Nanshan District,Shenzhen
Guangdong,China China

Description: There are one 3 chamber and one line conducted labs for final test. The 3m chamber and the Line Conducted labs are constructed and calibrated to meet the FCC requirements in documents ANSI C63.4 and CISPR 22/EN 55022 requirements.

Site Accreditation: Accredited by FCC, June 30,2010
The Certificate Registration Number. is 709623
Accredited by Industry Canada, November 15, 2010
The Certificate Registration Number. is 46405-4480
Accredited by CNAS , October 29, 2010
The Certificate Registration Number. is L2291
Accredited by VCCI , March 18, 2011
The Certificate Registration Number. is R-2777

Instrument Tolerance: All measuring equipment is in accord with ANSI C63.4 and CISPR 22 requirements that meet industry regulatory agency and accreditation agency requirement.

Ground Plane: Two conductive reference ground planes were used during the Line Conducted Emission, one in vertical and the other in horizontal. The dimensions of these ground planes are as below. The vertical ground plane was placed distancing 40 cm to the rear of the wooden test table on where the EUT and the support equipment were placed during test. The horizontal ground plane projected 50 cm beyond the footprint of the EUT system and distanced 80 cm to the wooden test table. For Radiated Emission Test, one horizontal conductive ground plane extended at least 1m beyond the periphery of the EUT and the largest measuring antenna, and covered the entire area between the EUT and the antenna. It has no holes or gaps having longitudinal dimensions larger than one-tenth of a wavelength at the highest frequency of measurement up to 1GHz.

TEST EQUIPMENT LIST

Instrumentation: The equipment conforms to the CISPR 16-1 / ANSI C63.2-1988 Specifications for Electromagnetic Interference and Field Strength Instrumentation from 10kHz to 1.0 GHz or above.

Equipment used during the tests:

For Conducted Emission Test

Item	Equipment	Manufacturer	Model No.	Serial No.	Last Cal.	Cal. Interval
1	Test Receiver	Rohde & Schwarz	ESCS30	828985/018	May 12, 2013	1 Year
2	L.I.S.N.	Rohde & Schwarz	ESH2-Z5	834549/005	May 12, 2013	1 Year
3	L.I.S.N.	Rohde & Schwarz	ESH2-Z5	834549/005	May 12, 2013	1 Year
4	Coaxial Switch	Anritsu	MP59B	M20531	May 12, 2013	1 Year

For Radiation Emission Test

Item	Equipment	Manufacturer	Model No.	Serial No.	Last Cal.	Cal. Interval
1	Spectrum Analyzer	ANRITSU	MS2661C	620012091 5	May 12, 2013	1 Year
2	LISN(EUT)	EMCO	3825/2	1371	May 12, 2013	1 Year
3	EMI Test receiver	Rohde&Schwarz	ESCS30	828985/018	May 12,2013	1 Year
4	Pre- Amplifier	HP	8447F H64	2944A0799 9	May 12,2013	1 Year
5	Bilog Antenna	schwarzbeck	VULB9163	142	May 12,2013	1 Year

The calibrations of the measuring instruments, including any accessories that may effect such calibration, are checked frequently to assure their accuracy. Adjustments are made and correction factors applied in accordance with instructions contained in the manual for the measuring instrument.

BLOCK DIAGRAM OF TEST SETUP

EUT : IP PHONE
Trade Name : N/A
Model Number : E52(P)

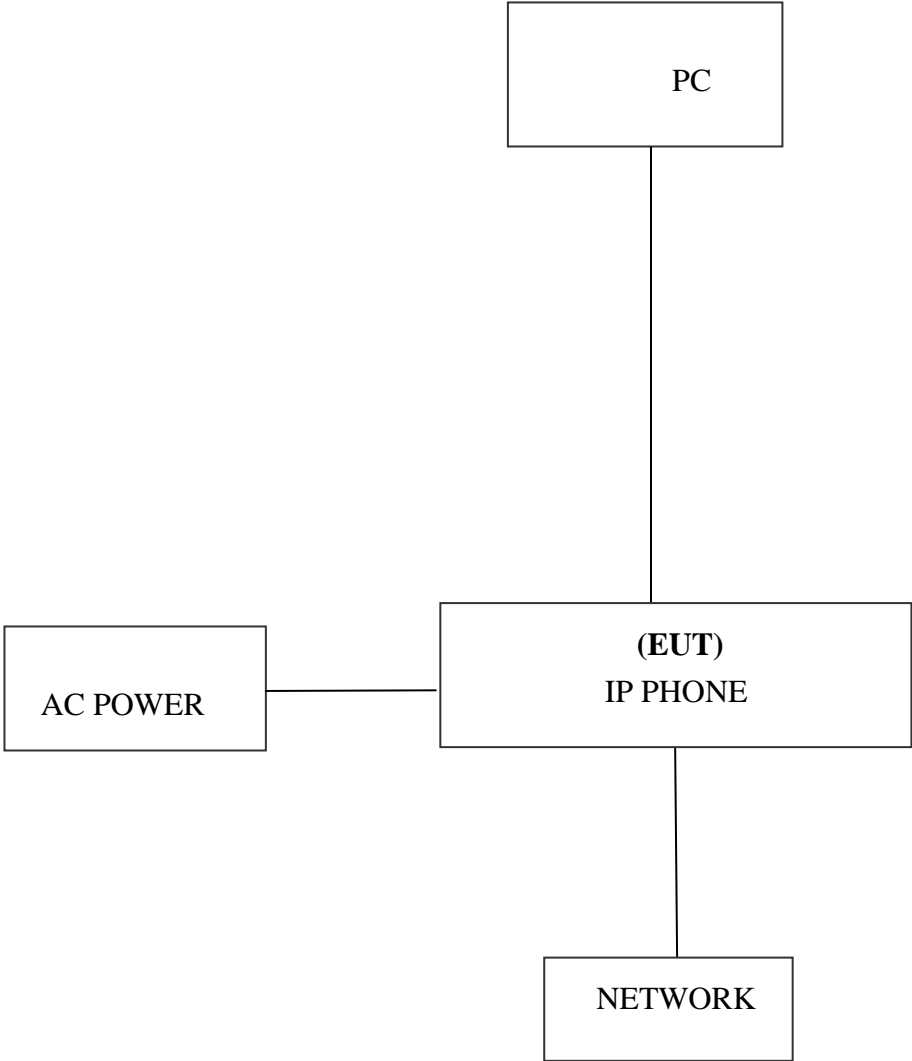

APPENDIX 1

PHOTOGRAPHS OF TEST SETUP

CONDUCTED EMISSION TEST



RADIATED EMISSION TEST



APPENDIX 2

PHOTOGRAPHS OF EUT

TOPVIEW OF EUT



BOTTOMVIEW OF EUT



OPEN OVERVIEW OF EUT

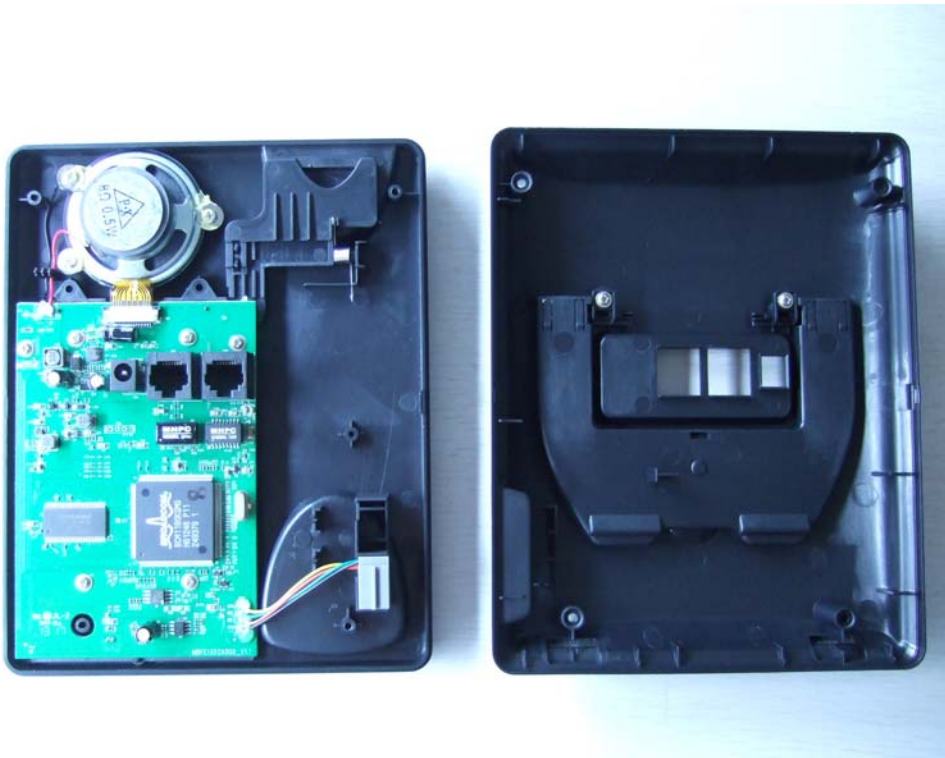

MAIN PCB1

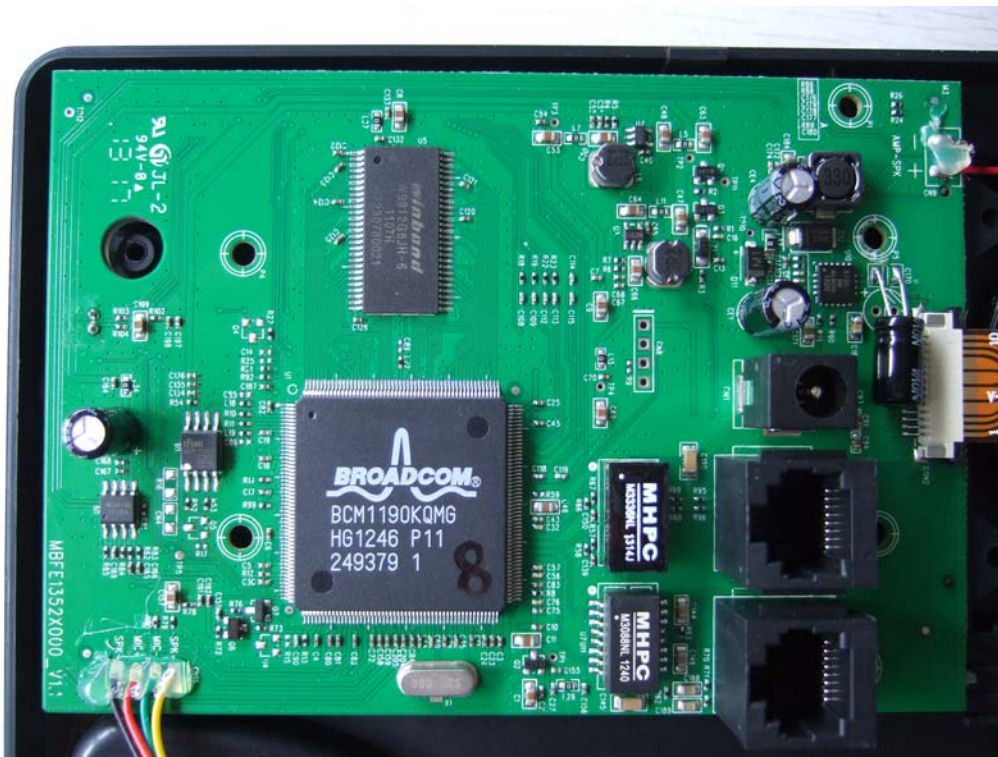

MAIN PCB2

